

Airseal

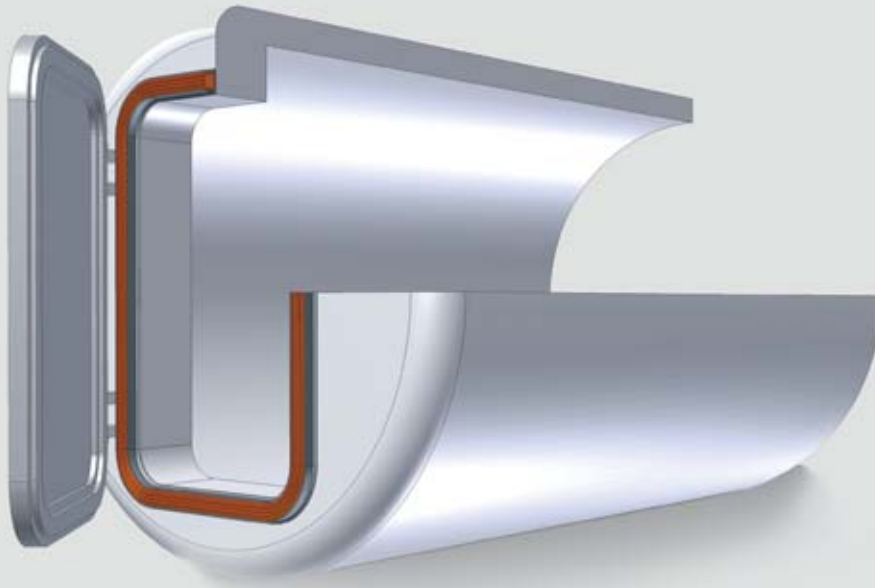

English



Your Partner for Sealing Technology



Your Partner for Sealing Technology

Trelleborg Sealing Solutions is a major international sealing force, uniquely placed to offer dedicated design and development from our market-leading product and material portfolio: a one-stop-shop providing the best in elastomer, thermoplastic, PTFE and composite technologies for applications in aerospace, industrial and automotive industries.

With 50 years of experience, Trelleborg Sealing Solutions engineers support customers with design, prototyping, production, test and installation using state-of-the-art design tools. An international network of over 70 facilities worldwide includes over 25 manufacturing sites, strategically-positioned research and development centers, including materials and development laboratories and locations specializing in design and applications.

Developing and formulating materials in-house, we utilize the resource of our material database, including over 2,000 proprietary compounds and a range of unique products.

Trelleborg Sealing Solutions fulfills challenging service requirements, supplying standard parts in volume or a single custom-manufactured component, through our integrated logistical support, which effectively delivers over 40,000 sealing products to customers worldwide.

Facilities are certified to ISO 9001:2008 and ISO/TS 16949:2009. Trelleborg Sealing Solutions is backed by the experiences and resources of one of the world's foremost experts in polymer technology: the Trelleborg Group.

ISO 9001:2008

ISO/TS 16949:2009

The information in this brochure is intended to be for general reference purposes only and is not intended to be a specific recommendation for any individual application. The application limits for pressure, temperature, speed and media given are maximum values determined in laboratory conditions. In application, due to the interaction of operating parameters, maximum values may not be achieved. It is vital therefore, that customers satisfy themselves as to the suitability of product and material for each of their individual applications. Any reliance on information is therefore at the user's own risk. In no event will Trelleborg Sealing Solutions be liable for any loss, damage, claim or expense directly or indirectly arising or resulting from the use of any information provided in this brochure. While every effort is made to ensure the accuracy of information contained herewith, Trelleborg Sealing Solutions cannot warrant the accuracy or completeness of information.

To obtain the best recommendation for a specific application, please contact your local Trelleborg Sealing Solutions marketing company.

This edition supersedes all previous brochures.
This brochure or any part of it may not be reproduced without permission.

© All trademarks are the property of Trelleborg Group.
The turquoise color is a registered trademark of Trelleborg Group.
© 2011, Trelleborg Group. All rights reserved.









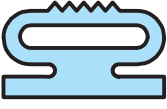
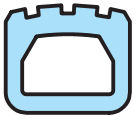

Contents

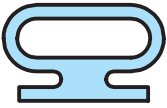
Overview of the Standard Cross Sections	2
Description.....	3
Applications.....	4
Applications in Detail.....	5
Airseal Materials.....	6
Design Instructions	7
Air Connections for Metric Dimensions.....	8
Air Connections for Inch Dimensions.....	9
Installation Recommendations.....	10
Standard Profiles – Low-pressure Types.....	11
Standard Profiles – High-pressure Types.....	17
End Plugs for High-pressure and Low-pressure Profiles	19
High Purity Inflatable Series.....	20
End Plugs for Fabric Reinforced Profiles.....	21
General Quality Criteria and Storage Guidelines.....	22
Engineering Action Request (EAR) for Airseal	24



■ Overview of the Standard Cross Sections

Profile Geometry	Design	Dimensions, see page	Examples
	Low-pressure profile without fabric reinforcement with peaked sealing profile	11	Doors and gates, heat chambers, dam bar seals
	High-pressure profile without fabric reinforcement with smooth sealing profile and grooves	17	Cockpit seals, plastics presses
	High-pressure profile without fabric reinforcement with peaked sealing profile	18	Sliding doors, autoclaves
	Low-pressure profile, fabric and non-fabric reinforced, smooth wide sealing surface, low specific surface load	12	Bulkhead seals, storage tanks, for frequent load changes
	Low-pressure profile, fabric reinforced, for large gaps, particularly pronounced sealing edge	14	Doors and gates, for high cycle rates, personnel locks
	Low-pressure profile, fabric reinforced, sealing edge with special profile	15	Conditioning chambers with large numbers of cycles
	Low-pressure profile, fabric reinforced, smooth sealing surface	15	Sluices, discharge hoppers
	Low-pressure profile, fabric reinforced, specially formed sealing edge	16	Bulkhead seals, filling hoppers
	Low-pressure profile, fabric reinforced, smooth sealing surface	16	Storage tanks, conditioning chambers
	High-pressure profile without fabric reinforcement, excellent smooth top sealing surface	20	Doors and gates in clean environment



■ Description

Airseals are tubular elastomer seals which are activated by internal pressurisation (inflatable seals). Airseals are used wherever reliable sealing of accesses to plants, containers and rooms is demanded. They represent a technically improved alternative to the known contact pressure seals. The wide range of high-pressure and low-pressure seals and the numerous elastomer materials offer the designer potential solutions to an enormous variety of applications. Airseals can be easily adapted to match of the surface to be sealed and are therefore generally manufactured to the customer's drawings.

We are naturally most willing to advise you on your own draft designs.

Characteristics

A fundamental distinction is made between

- High-pressure profiles
- Low-pressure profiles
- Materials with and without fabric reinforcement

The ends of seals without closed geometries can be closed off using vulcanised end plugs. These end plugs cannot be inflated, however, and this has to be taken into consideration during the seal design. Right-angled (axial) corner designs are possible with certain profiles.

Method of Operation

The profile is expanded in a predetermined direction by pressurisation (inflation) with air - in exceptional cases, with other gases and water. The sealing function is effected by the contact pressure with the mating surface.

If the profile is chambered, the groove flanks protect the Airseal from mechanical damage.

Figure 1 shows an Airseal at rest and in activated state.

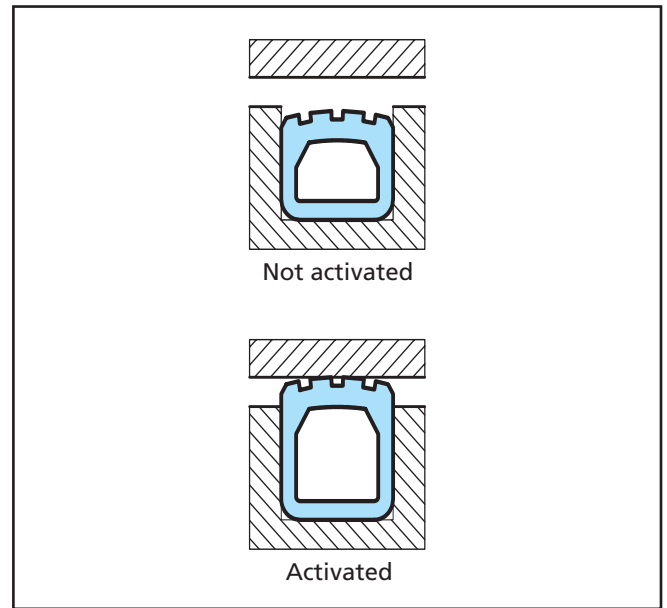

Figure 1 Airseal

Advantages

Airseals offer a large number of advantages compared with the conventional contact pressure seals:

- Faster and tighter closing of large sealing surfaces, able to seal gaps with wide tolerances
- No deterioration in the sealing function over the service life
- Tight sealing under pressure and under vacuum
- Automatic pressure monitoring possible
- No high demands on the flatness and surface finish of the mating surface
- High mechanical load-bearing strength thanks to fabric reinforcement
- Long service life even with frequent load changes

















■ Applications

The range of potential applications for the Airseal is unlimited. Its use is recommended wherever frequent activation and deactivation of a static seal is demanded.

A selection of typical applications taken from the range of potential applications for Airseals are given below.

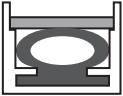
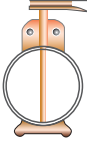
TSS specializes in the custom design and manufacture of inflatable rubber products, seals, and other engineered rubber devices. We will carefully analyze your problem, apply our extensive technical knowledge, and follow your project through to an efficient solution. Advanced compounding, molding, extruding, fabricating, coupled with testing equipment and processes enable us to address your most demanding needs for rubber fabrications that require a high level of durability and reliability.

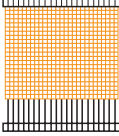
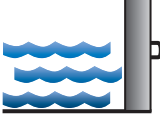
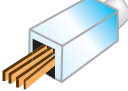
	Powder & Bulk Solids Processing Equipment: Mixers, blenders, screeners, dryers, chutes, hoppers, valves
	Electronic/Wafers Semiconductor Processing: Washers, soldering equipment, furnaces, filters, loadlocks, measuring equipment, actuators
	Paper Machinery: Seals for the wet end of paper machinery, doctor blade bladders, inflatable bladders for expanding mandrels for slitters and scorers
	Conveyors: Conveyor stops, brakes, bumpers
	Food Processing Equipment: Smokehouse door seals
	Marine: Cargo hatches, elevator platforms, maintenance or shut down seals on propeller shafts, personnel hatches

	Transportation: High speed trains, tailgate seals, automobile emission control test sheds
	Medical: Virology laboratories, clean rooms, sterilizer
	Aerospace/Aircraft: Wind tunnels, jet engine test cells, bladders for bonding and clamping fixtures, door and hatch seals
	Converting Equipment: Access way seals
	Robotics Material Handling: Clamps, grips, actuators
	Fluid Sealing: Isolation valve seals, follower plate seals, maintenance shutdown shaft seals
	Nuclear: Door and hatch seals, pool gate seals, refueling seals, nozzle dam seals
	Wineries: Lid seals for variable capacity wine tank
	Textile Machinery: Pressure chambers, inflatable clamps
	Flood Protection: Gate and door seals
	Wood Processing: Drying kilns, log preparation chambers
	Commercial Laundry Machinery: Door seals



■ Applications in Detail

Technical Data

Airseals can be used for a wide range of applications. The seal and material selection are determined by pressure requirements, temperature and medium to be sealed.

Pressure Requirements

Airseals can – depending on profile and design – be used for sealing pressures up to 0.8 MPa (8 bar), whereby the ambient pressure should be approx. 80 % of the internal seal pressure.

With a good surface finish of groove and mating surface, a dynamic vacuum of 10^{-3} Torr can be safely handled.

Internal Pressure of Airseal

The maximum permissible internal pressure is dependent on:

- Profile cross-section
- Seal gap
- Chambering
- Design

The permissible activation pressure for low-pressure profiles is max. 0.30 MPa (3.0 bar), for high-pressure profiles 0.8 MPa (8 bar), dependant on profile size.

In uninstalled state, the Airseal may be subjected to a maximum test pressure of 0.1 MPa (1 bar).

Temperature

The temperature range depends on the seal material used. The limits lie between - 60°C and + 200°C.

Media

The media resistance is also dependent on the selected seal material. The table on page 6 shows the available materials.

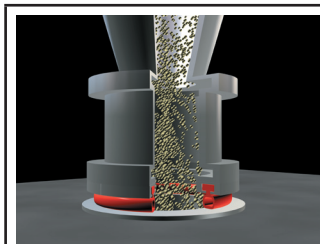

Hopper to Transfer Cart:
Airseal on the mouth of the hopper valve or metering device expands axially down to form a leak-tight seal around the fill opening in a transfer cart.



Slide Gate Valves:
Airseal provides the tightest seal possible for controlling the flow of very fine materials. The inflation and deflation of the seal is timed to coincide with the closing and opening of the slide gate.

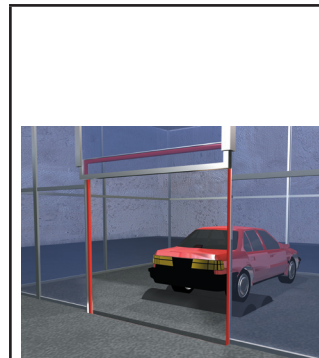

Automobile Emission Control Test Shed Door Seals:

Airtight enclosures help automotive engineers evaluate carburetor and fuel tank vent evaporative emissions. Warmed up test vehicles are pushed into hot soak enclosures. Escaping fuel vapors are measured by instruments outside the test cells. The doors to the cells are typically sealed using the HP profile Airseal design supplied in either EPDM (EP) or Neoprene (CR)



Airtight Doors:

Airtight doors in virology laboratories, animal rooms, and decontamination areas are tightly sealed with Airseals installed around the periphery of the door to expand radially outward. This design facilitates frequent access since there is no requirement to actuate multiple dogs and there is no raised sill to obstruct personnel and equipment traffic.

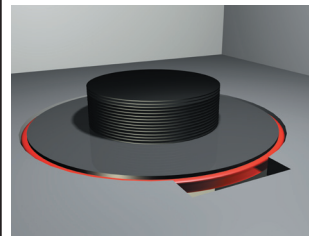

Load-Lock:

TSS manufactures a unique inflatable seal made of low outgassing Butyl rubber material which has been tested for vacuum service. This design provides a highly efficient and repeatable seal in the patented vacuum load lock section of a fully automated electron beam metrology system.

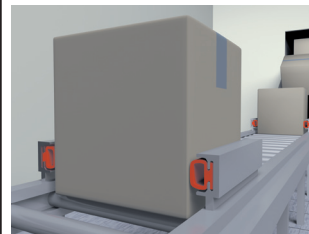

Conveyor Stops/Brakes:

Airseal inflatable bladders represent two different ideal solutions to controlling and preventing jams on conveyor systems. Positioned alongside the product at the outer extremities of the conveyor belt (or rolls), they can be inflated against the product to temporarily interrupt the flow while the jam clears downstream. Alternately the bladders can be located underneath the product flow and activated to release the contact between belt and rollers, thereby interrupting flow while the jam clears.



Airseal

■ Airseal Materials

Airseal is available in a wide variety of materials as noted below, although the specific elastomers vary somewhat from one profile to another. If required, cross sections can be custom made using materials other than those indicated in this manual. Please note that the ratings given to the properties of the elastomers are based on Airseal compounds as they are applied to inflatable seals.

The ratings of other manufacturers may differ as the result of compounding variables and end product use. Also note that the addition of fabric reinforcing overcomes drawbacks associated with some of the relatively poor physical characteristics of silicone, fluorosilicone, fluorocarbon rubber, and nitrile.

Common Name - Base Polymer	EPDM or EP Rubber		Nitrile or NBR or Buna-N	Natural Rubber	Butyl	Silicone	Fluoro-silicone	
Chemical Name	Ethylene Propylene			Natural Isoprene	Iso-butylene Isoprene	Silicone	Fluoro-silicone	
ASTM Designation (ASTM D1418)	EP	CR	NBR	NR	IIR	VMQ	FVMQ	FKM
Tensile Strength (psi)	>2000	>2000	>2000	>2000	>2000	>1200	>1200	>1400
Hardness Range (Durometer A)	40-90	20-80	50-95	50-70	40-75	40-80	40-70	70-90
Tear Resistance	G	G	F	G	G	F	P	F
Abrasion Resistance	G to E	VG	G	E	G	P	F	G
Compression Set	G	G	G	E	F	VG	E	E
Resilience Cold	G	G	G	G	P	E	G	F
Resilience Hot	VG	VG	G	F	VG	E	E	E
Radiation Resistance	O	G	P	F to G	G	G	E	E
Impermeability to Gases	G	G	G	F	O	F	E	P
Acid Resistance								
Mild Dilute	E	E	F to G	F to P	E	E	E	O
Strong Concentrate	G	G	F to G	P	G	F	G	E
Solvent Resistance								
Aliphatic Hydrocarbons	P	F to G	E	P	P	P	G	E
Aromatic Hydrocarbons	P	P	P	P	P	P	E	E
Oxygenated (Ketones, etc)	G	P	P	P	G	P	F	F
Resistance To								
Swelling in Lubricating Oil	P	G	VG	P	P	P	E	O
Oil and Gasoline	P	G	E	P	P	F	G	E
Animal Oils	F	F	E	P	F	G	E	E
Water Absorption	VG	G	VG	VG	VG	E	E	E
Oxidation	E	VG	G	F to P	E	E	O	O
Ozone	O	VG	F	F to P	F to G	E	O	E
Sunlight Aging	O	VG	P	F to P	VG	E	E	G
Heat Aging	VG	G	G	G to F	G	O	E	E
Low Temperature	VG	G	F to G	G	G	O	G	F
Flame	P	G	P	P	P	F	E	E
Vegetable Oils	F	G	G	P	F	P	E	E
Chlorinated Hydrocarbons	P	P	F	P	P	P to F	F	G

O = Out-standing E = Excellent VG = Very Good G = Good F = Fair P = Poor



■ Design Instructions

Selection of the seals

A wide range of applications can be covered thanks to the large number of different profile geometries.

Airseals can be used for axial-expanding and radial-expanding applications.

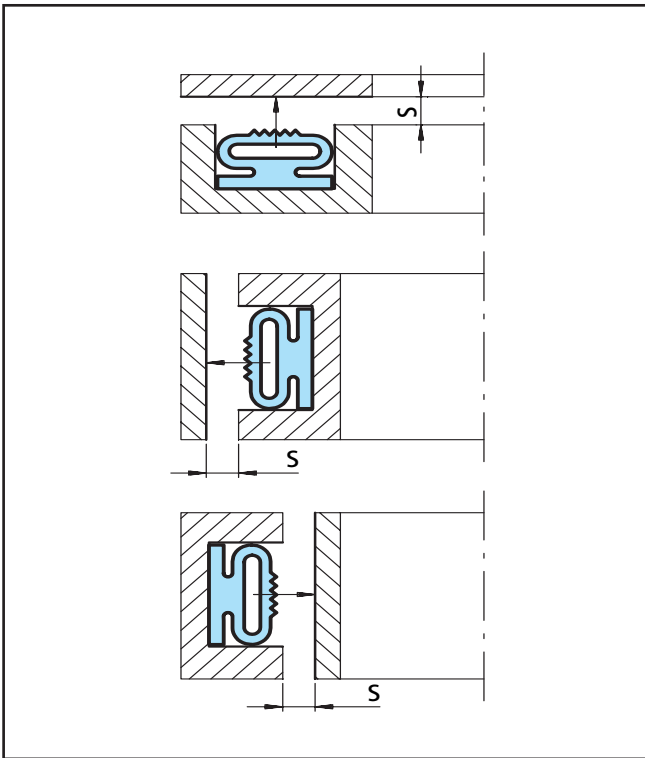

Figure 2 Installation examples

Inside diameters > 50.0 mm and seal gaps \leq 75.0 mm can be reliably sealed with an Airseal.

Corner Formation

The simplest and least costly corner design is the use of a radius. The corresponding minimum radii must be observed for the particular profile. The necessary information can be found in the dimension tables.

Note:

The radii given in the tables apply only for VMQ seals. For all other materials, these should be increased by at least 20 % in order to ensure proper functioning. Please contact the TSS organization for further details.

If, for design reasons, radii are not permissible, right-angled corner designs can be manufactured from fabric-reinforced profiles with a limited number of cross sections. (possible for axial sealing). Please contact TSS for this information.

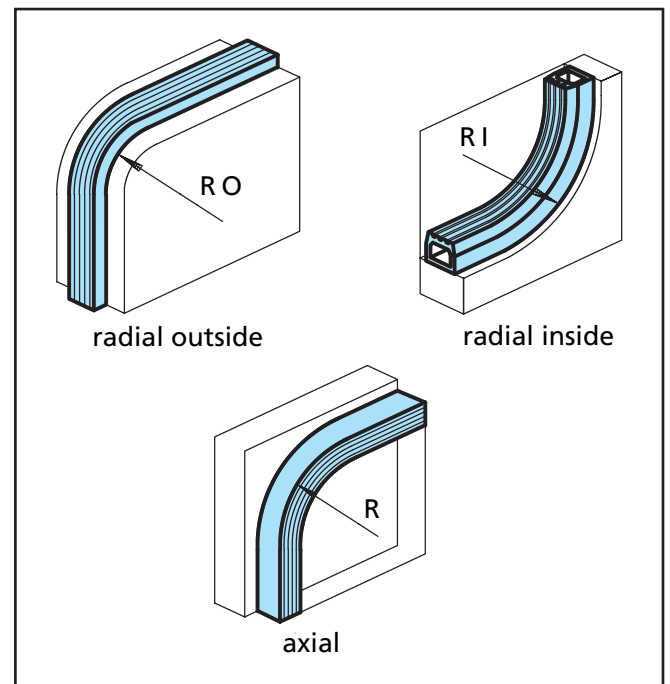

Figure 3 Design example

Seal Gaps

The maximum permissible seal gap is specified in the dimension tables. As a general rule of thumb: The smaller the selected seal gap, the shorter the activation time for the Airseal and the smaller the axial load on the seal due to the ambient pressure.

Furthermore, small seal gaps permit higher internal pressures.

Surfaces

All surfaces coming into contact with the seal must be cleanly machined and have no burrs. Any weld peaks must be cleanly dressed and exhibit no unevenness.

Neither pointed nor sharp edges must be allowed to come into contact with the Airseal. The recommended surface finish for the groove and mating surface is:

Ra 0.8 to 1.6 mm; Rmax 4 to 10 mm



Airseal

Air Connections for Metric Dimensions

The air connections and valves can generally only be provided on the bottom surface of the profile on Airseals. With some profiles it is possible to vulcanise the

connections also into the side wall. Please contact TSS for standard stem designs to avoid tooling cost wherever possible.

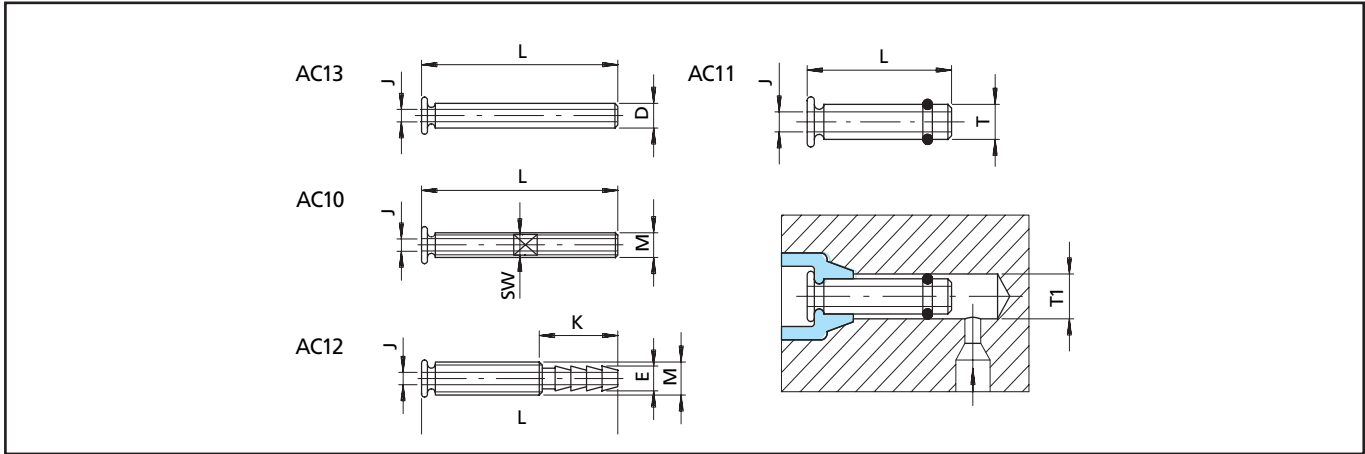

Figure 4 Form of standard connections

Table I Connections

AC13	D	4	6	8	10	12	14	16
AC10	M	M4	M6	M8	M10	M12	M14	M16
	SW	3	5	6	8	10	11	13
AC12	M	M6	M8	M10	M14			
	E	4	6	8	10	12		
	K	12	20	20	25	25		
AC13	J	1.5	3	4	6	8	8	10
AC10	L	50	50	60	70	70	80	80
AC12								
AC11	Th7	-	5.8	7.8	9.8	11.8		
	T1H8	4H8	6H8	8H8	10H8	12H8		
	J	1.2	2	3	4	5		
	L	20	25	30	30	30		

Table II Cones

Cones m x n x h	AC13	AC10	AC12	AC11
6 x 5 x 3*	D4	M4	-	4
8 x 6 x 4				
12 x 10 x 6	D6	M6	E4 - M6	6
14 x 12 x 6	D8	M8	E6 - M8	8
21 x 14 x 10	D10	M10	E8 - M10	10
24 x 16 x 10	D12	M12	E10 - M12	12
26 x 18 x 12	D14	M14	E12 - M14	-
28 x 20 x 12	D16	M16	-	-

* For profile 6.5 x 5 (973)

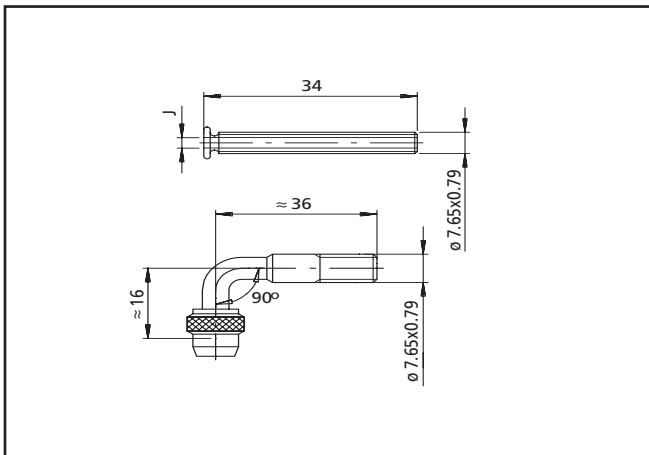

Figure 5 Form of standard valves

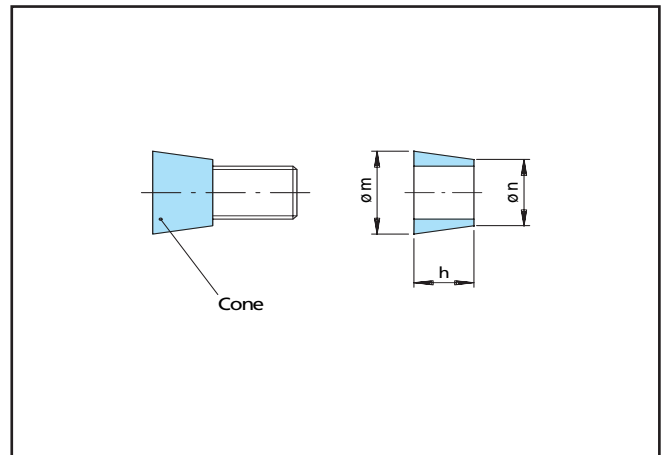

Figure 6 Cone configuration



■ Air Connections for Inch Dimensions

	<p>Type AC1A, AC1C</p> <p>1/8" I.D. Flexible tube (non-reinforced). Same material as Seal.</p> <p>1/8"-27 NPT connector with barbed end supplied as a loose item — barbed end is inserted in tube after tube is passed through clearance hole.</p>	<p>Type AC1B, AC1C</p> <p>1/8" I.D. Flexible tube (non-reinforced). Same material as Seal.</p> <p>Tire valve core connector with barbed end supplied as a loose item — barbed end is inserted in tube after tube is passed through clearance hole.</p>	<p>Type 1A: 9/32" diameter clearance hole required (break edge or counter sink).</p> <p>Type 1B: 9/32" diameter clearance hole required (break edge or counter sink).</p> <p>Type 1C: 11/32" diameter clearance hole required (break edge or counter sink).</p> <p>Type 1D: 11/32" diameter clearance hole required (break edge or counter sink).</p>
	<p>Type AC2</p> <p>Crimped Ferrule 3/8" O.D.</p> <p>3/16" I.D. x 3/8" O.D Reinforced Hose</p> <p>1/8"-27 NPT connector with barbed end supplied as a loose item — barbed end is inserted in tube after tube is passed through clearance hole.</p>	<p>Type AC3A</p> <p>Crimped Ferrule .48" O.D.</p> <p>1/4" I.D. x .47" O.D Reinforced Hose</p> <p>1/8"-27 NPT Connector</p>	<p>Type AC3C</p> <p>1/8"-27 NPT Connector</p> <p>1/4" I.D. x .47" O.D Reinforced Hose</p> <p>1/8"-27 NPT Connector</p>
<p>13/32" diameter clearance hole required. Crimped Ferrule is not included on some silicone seals.</p>	<p>1/2" diameter clearance hole required. Crimped Ferrule is not included on some silicone seals.</p>	<p>19/32" diameter clearance hole required.</p>	
	<p>Type AC4A</p> <p>1/8"-27 NPT Straight Thread</p> <p>Wrench Flats</p> <p>1/8"-27 NPT Tapered Thread</p>	<p>Type AC4B</p> <p>Clamped in Base with Crimped Ferrule .48" O.D.</p> <p>1/4" I.D. x .47" O.D Reinforced Hose</p> <p>1/8"-27 NPT Connector</p>	<p>Type 5</p> <p>15/16" Ref.</p> <p>Contains "Tire" Valve Core (Material: Brass or Nickel Plated Brass)</p>
<p>7/16" diameter clearance hole with 31/32" diameter x 5/16" deep counterbore for nut and washer or 31/32" diameter clearance for entire assembly.</p>	<p>1/2" diameter clearance hole with 31/32" diameter x 5/16" deep counterbore for nut and washer or 31/32" diameter clearance for entire assembly.</p>	<p>For seals requiring automotive type valve cores. 5/16" diameter clearance hole with 5/8" diameter x 7/32" deep counterbore for nut and washer or 5/8" diameter clearance for entire assembly.</p>	



Installation Recommendations

Mounting of Airseal

The high-pressure seals (HP) are installed in the groove without additional installation elements. These seal types are bonded onto the groove bottom, but the seal flank must remain free to move. We recommend the use of our „Airgrip“ adhesive.

Low-pressure seals (LP) are generally secured mechanically with clamping elements. Figure 7 and Table III show the mounting elements with the corresponding installation dimensions.

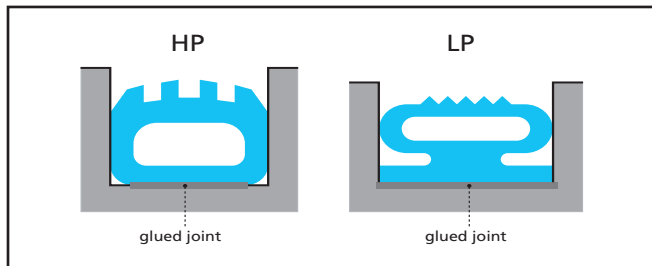

Figure 7 Installed Airseal in groove

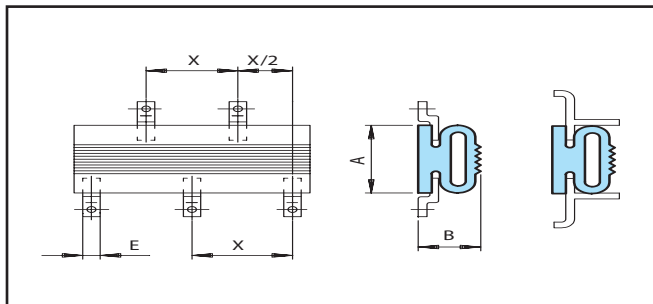

Figure 8 Mounting elements

Table III Installation Dimensions of Low-pressure Seals

Profile A x B	X	X/2	E
30 x 20	150	75	9.5
40 x 27	250	125	12
60 x 35	250	125	12
90 x 55	380	190	12

Seal Installation

In order to guarantee the proper functioning of the Airseals, the sealing surface and groove must be thoroughly cleaned before installation of the seal. If the seal is to be bonded, the groove root must be degreased. Sharp peaked tools must not be used for installation.

The Airseal must be deflated before the start of installation.

The air connection is first inserted into the bore without tightening the locknut. Non-return valves must be removed before the start of installation.

In order to guarantee the optimum seating of the Airseal in the groove, the seal must be activated immediately after insertion. Care must be taken here that the mating surface is always in contact and that in addition, the complete seal of the high-pressure types is chambered. During the bonding process, the Airseal must remain activated until the Airgrip adhesive has completely hardened.

Installation of the Air Connections

All threaded air connections are locked with the supplied washer and nut. During tightening of the locknut, ensure that the adhesive has hardened and the seal is not damaged. The nuts may only be tightened by hand unless the stem design has wrench flats. Wrench flats must be held securely when tightening nuts with a wrench.

Please have a look in our special Airseal installation instructions.

Seal Operation

Depending on the seal material, the Airseal can be activated with air, neutral gases or with water. The materials CR, VMQ and EPDM may only be operated with oil-free air.

If the activation cycle of the Airseal is longer than 3 hours, a constant pressure supply must be assured. Any pressure fluctuations should be compensated using pressure regulators.

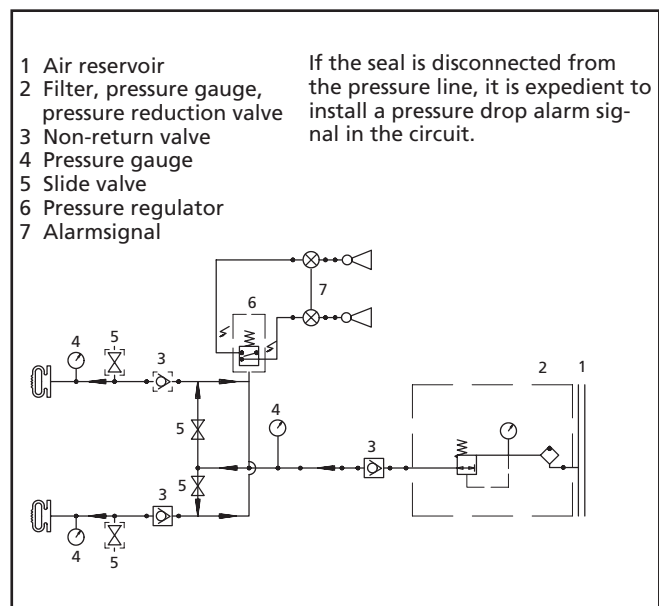

Figure 9 Circuit diagram – Airseal



■ Standard Profiles – Low-pressure Types

Metric Dimensions without Fabric Reinforcement for chambered and non-chambered installation.

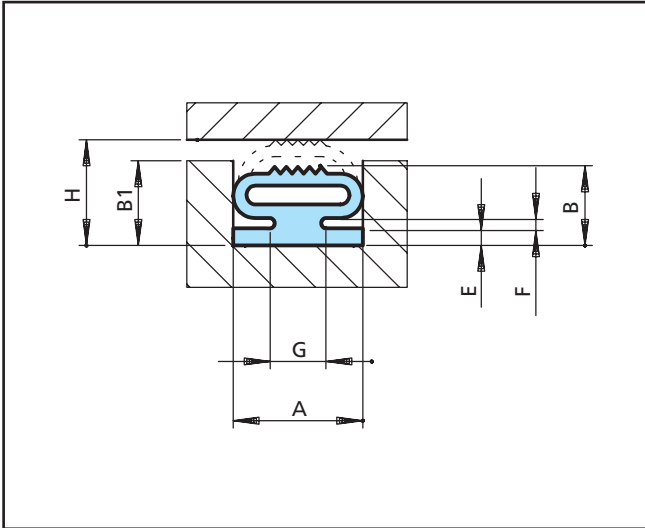

Figure 10 Low-pressure profiles

Dimension B shows the Airseal at rest. If the seal is pressurised with 1.5 bar, it reaches its maximum height. Dimension H indicates the maximum expansion. The heights between B and H can also be used. The seal foot must be secured at the sides as the Airseal exerts forces on the flanks under pressure and moves.

Note:

For chambered installations the Low-pressure Profile must be bonded onto the bottom of the groove.

Please contact TSS for fabric reinforced profiles.

Table IV Dimensions and Profiles Numbers

Profile Ref. No.		Profile Dimensions							Max. Internal Pressure P_i
VMQ	EPDM	A x B	H	E	F	G	B1		
951-5	951-6	30.0 x 20.0	25.0	4.0	4.0	12.0	22.0	0.3	
9185-5	9185-6	40.0 x 27.0	35.0	5.0	5.0	15.0	29.0	0.3	
946-5	946-6	60.0 x 35.0	50.0	6.0	6.0	25.0	38.0	0.3	
974-5	974-6	90.0 x 55.0	75.0	8.0	8.0	30.0	60.0	0.3	

Table V Recommended Minimum Radii and Valve Connections

Profile Ref. No.	Radii			Connections			
	R axial	RO	RI	AC13- \emptyset	AC10	AC12- \emptyset	AC11- \emptyset
951	130	86	124	8.0	M8	E6-M8	8
9185	168	100	140	10.0	M10	E8-M10	10
946	240	108	168	16.0	M16	12-M14	12
974	240	140	400	16.0	M16	E12-M16	12



Inch Dimensions with Fabric Reinforcement

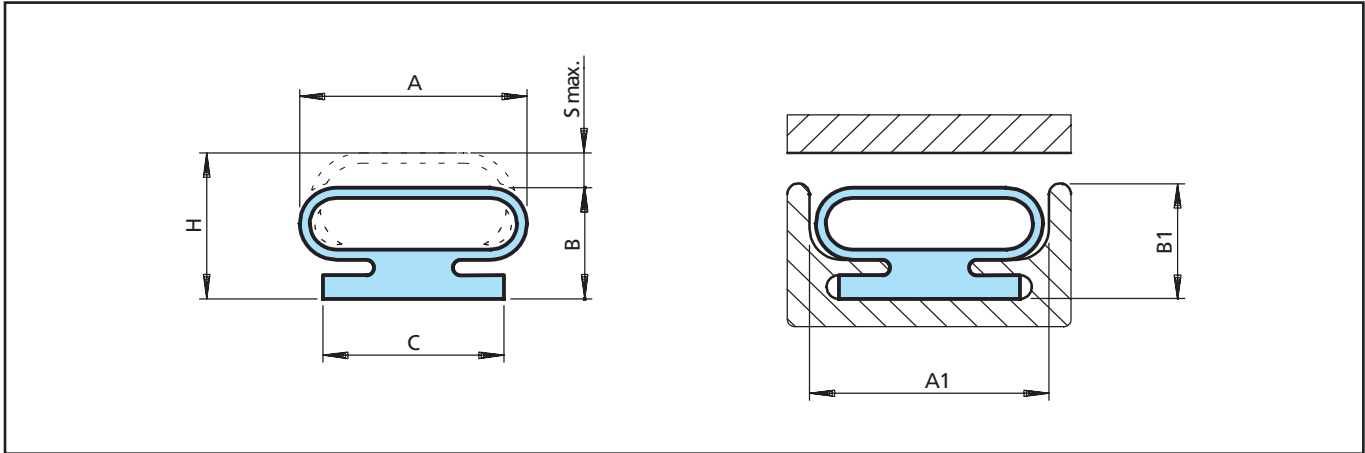

Figure 11 Low-pressure profile with fabric reinforcement

Table VI Dimensions and Profile Numbers with Fabric Reinforcement

Profile Ref. No.			Profile Dimensions						
VMQ	CR	EPDM	A x B	A1	B1	H	S max.	C	Max. Internal Pressure Pi MPa
717-5	-	717-6	25.4 x 12.7	26.0	13.0	20.5	7.8	19.0	0.3
580-5*	-	580-6	32.0 x 16.0	32.5	18.5	25.0	9.0	25.4	0.3
582-5*	582-2	582-6	51.0 x 22.5	51.5	23.0	41.0	18.5	44.5	0.3
583-5*	583-2	583-6	76.5 x 32.0	77.0	32.5	63.5	31.5	51.0	0.3
-	-	705-6	101.5 x 41.5	102.0	42.0	73.0	31.5	76.5	0.3

* Retention system available

Table VII Recommended Minimum Radii and Valve Connections

Profile Ref. No.	Radii			Connections		
	R axial	RO	RI	AC2	AC3	AC3B
717	64.0	76.0	130.0	X		
580	64.0	90.0	178.0	X		
582	105.5	102.0	298.0		X	X
583	152.0	139.0	317.0		X	X
705	203.0	203.0	457.0		X	X



Inch Dimensions without Fabric Reinforcement

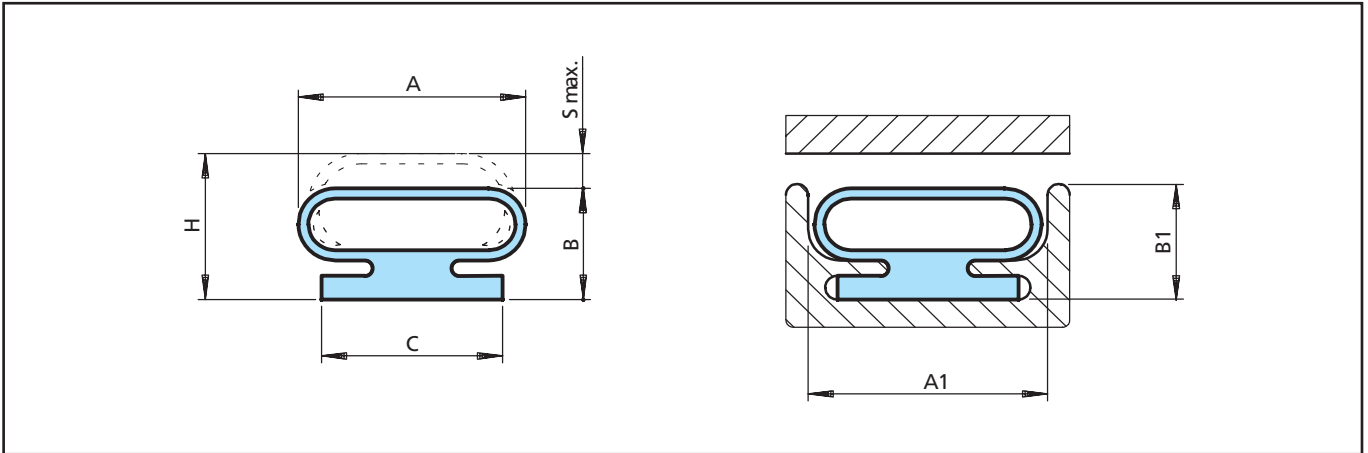

Figure 12 Low-pressure profile without fabric reinforcement

Table VIII Dimensions and Profile Numbers without Fabric Reinforcement

Profile Ref. No. Non-Reinforced			Profile Dimensions						
VMQ	CR	EPDM	A x B	A1	B1	H	S max.	C	Max. Internal Pressure Pi MPa
573-5	573-2	573-6	17.5 x 11.0	18.0	11.5	14.2	3.2	17.5	0.15
-	-	978-6	25.4 x 12.7	26.0	13.0	19.0	6.3	19.0	0.15
535-5	535-2	535-6	50.8 x 22.2	51.5	23.0	41.2	19.0	44.5	0.15
-	548-2	548-6	76.2 x 32.0	77.0	32.5	57.4	25.4	50.8	0.15
-	934-2	-	101.6 x 41.5	102.0	42.0	76.5	35.0	76.2	0.15

Table IX Recommended Minimum Radii and Valve Connections for non-fabric-Reinforcement

Profile Ref. No. Non-Reinforced	Radii			Connections									
	R axial	RO	RI	1A	1B	1C	1D	4A	4B	6	8	10	11/12
573	52.0	38.0	152.0	X	X							X	X
978	64.0	44.0	178.0	X	X							X	X
535	114.0	102.0	298.0			X	X	X	X			X	X
548	152.0	140.0	406.0			X	X	X	X			X	X
934	200.0	150.0	500.0			X	X	X	X	X	X	X	X



Inch Dimensions with Fabric Reinforcement

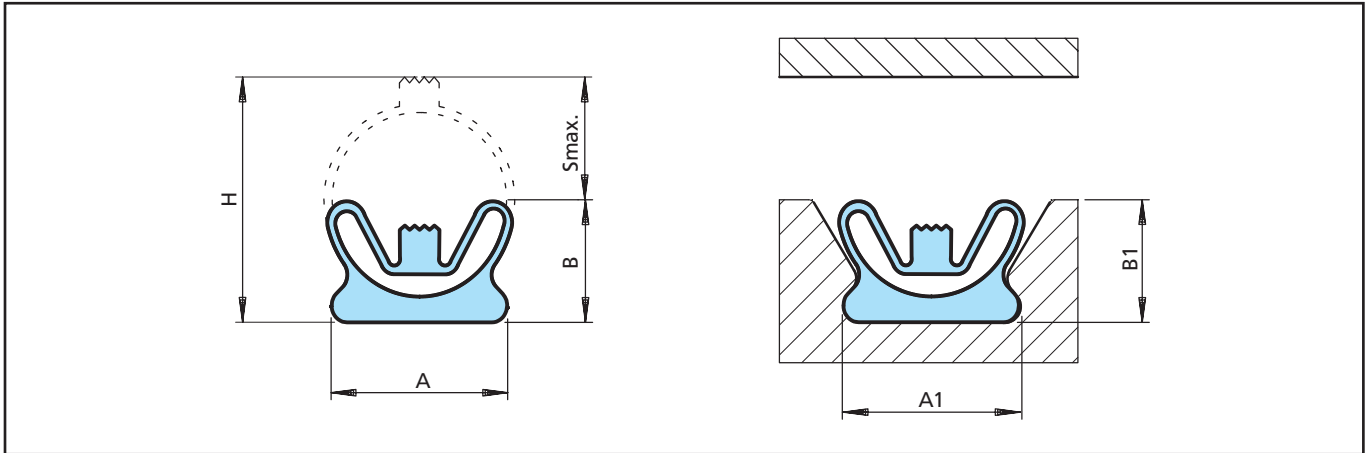

Figure 13 Fabric profile (expandable)

Table X Dimensions and Profile Numbers

Profile Ref. No.		Profile Dimensions					
VMQ	EPDM	A x B	A1	B1	H	S max.	Max. Internal Pressure Pi MPa
591-5*	591-6	17.5 x 12.5	18.0	13.5	22.0	9.5	0.28
595-5	595-6	22.0 x 12.5	22.5	13.5	22.0	9.5	0.28
581-5*	581-6	22.0 x 16.0	22.5	16.5	28.5	12.5	0.28
-	594-6	44.5 x 31.0	45.0	32.0	61.0	30.0	0.28

* Retention system available

Table XI Recommended Minimum Radii and Valve Connections

Profile Ref. No.	Radii			Connections	
	R axial	RO	RI	AC2	AC3A
591	51.0	254.0	127.0	X	
595	87.0	254.0	127.0	X	
581	87.0	305.0	152.0	X	
594	127.0	457.0	203.0		X



Inch Dimensions with Fabric Reinforcement

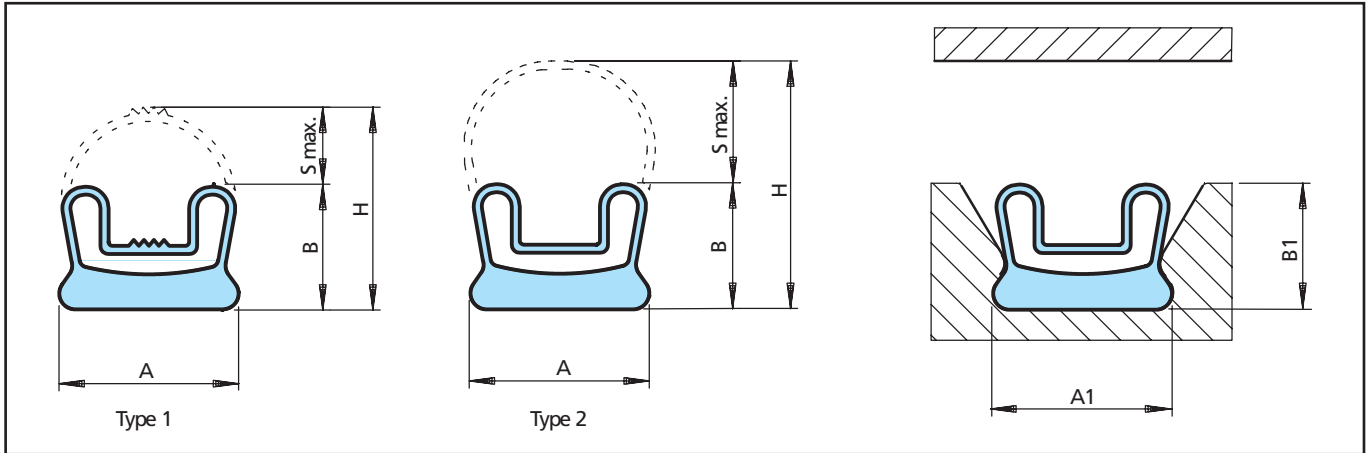

Figure 14 Fabric profile (expandable)

Table XII Dimensions and Profile Numbers

Profile Ref. No.	Profile Dimensions						Max. Internal Pressure P_i MPa	
	A x B	A1	B1	H	S max.			
592-6*	16.0 x 12.7	16.5	13.0	18.5	6.3	Type 1	0.28	
708-6*	44.5 x 12.5	45.0	32.0	61.0	20.0	Type 2	0.28	

* Retention system available

Table XIII Recommended Minimum Radii and Valve Connections

Profile Ref. No.	Radii			Connections	
	R axial	RO	RI	II	III A
592	5.0	127.0	254.0	X	
708	127.0	203.0	457.0		X



Inch Dimensions with Fabric Reinforcement

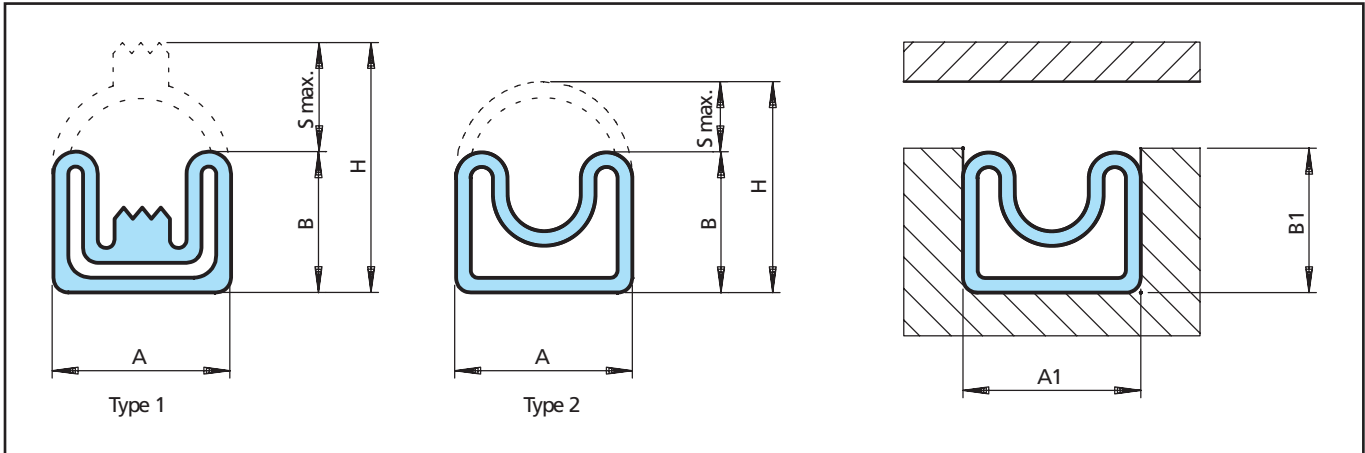

Figure 15 Fabric profile (expandable)

Table XIV Dimensions and Profile Numbers

Profile Ref. No.	Material	Profile Dimensions						Max. Internal Pressure P_i MPa	
		A x B	A1	B1	H	S max.	Type	Value	
715-5	715-6	13.5 x 11.0	14.0	11.5	20.5	9.5	Type 1	0.24	
707-5	707-6	16.5 x 11.0	17.0	11.5	20.5	12.5	Type 1	0.24	
732-5	732-6*	23.8 x 19.0	24.0	24.5	29.5	10.5	Type 2	0.24	

* EPDM is only available for straight seals with sealed ends in EPDM

Table XV Recommended Minimum Radii and Valve Connections

Profile Ref. No.	Radii			Connections
	R axial	RO	RI	AC2
715	67.0	102.0	178.0	X
707	67.0	102.0	178.0	X
732	105.0	152.0	254.0	X



■ Standard Profiles – High-pressure Types

Metric Dimensions without Fabric Reinforcement

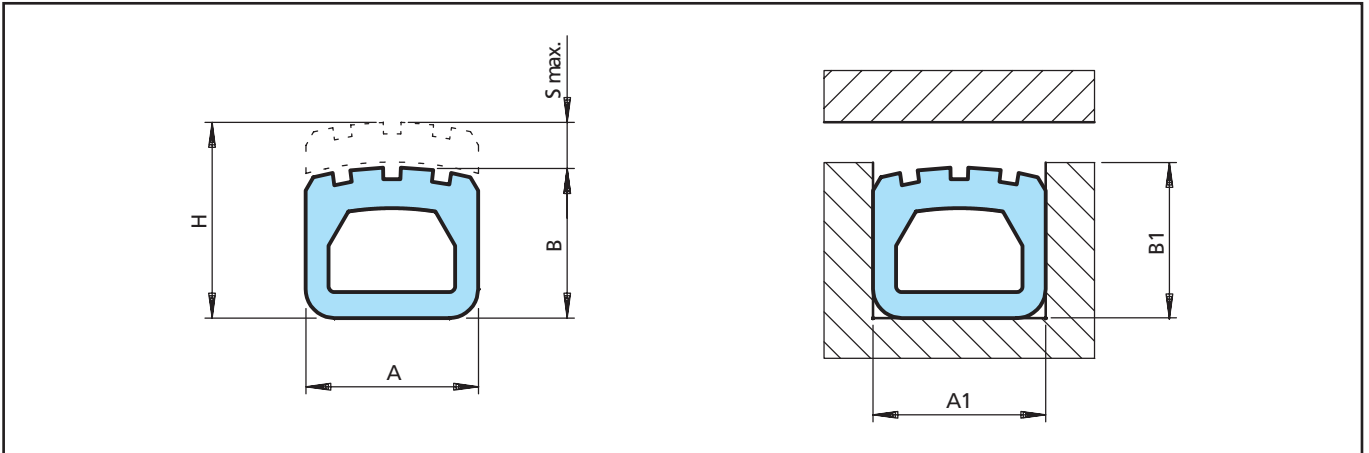

Figure 16 Standard high-pressure profile. metric

Table XVI Dimensions and Profile Numbers

Profile Ref. No.		Groove Dimensions						Max. Internal Pressure P_i MPa
VMQ	EPDM	A x B	A1	B1	H	S max.		
950-5	950-6	16.0 x 12.0	16.0	13.0	15.0	3.0	0.4	
960-5	960-6	16.0 x 18.0	16.0	19.5	21.5	3.5	0.4	
955-5	955-6	22.0 x 19.0	22.0	20.5	22.5	3.5	0.6	
952-5	952-6	26.0 x 19.0	26.0	20.5	23.5	4.5	0.6	
949-5	-	27.0 x 21.0	27.0	23.0	26.0	5.0	0.6	
972-5	972-6	35.0 x 26.0	35.0	29.0	34.0	8.0	0.8	
6119-5	6119-6	35.0 x 32.0	35.0	35.0	45.0	13.0	0.8	
15092-5	15092-6	14.0 x 10.0	14.0	11.0	13.0	3.0	0.4	
945-5	945-6	14.0 x 11.0	14.0	12.5	14.5	3.0	0.4	

Table XVII Recommended Minimum Radii and Valve Connections

Profile Ref. No.	Radii			Connections (min. - max.)			
	R axial	RO	RI	AC13- \emptyset	AC10	AC12- \emptyset	AC11- \emptyset
950	41.0	41.0	51.0	4-8	M4-M8	E4-E6	6-8
960	32.0	54.0	83.0	4-8	M4-M8	E4-E6	6-8
955	60.0	41.0	64.0	4-8	M4-M8	E4-E6	6-8
952	68.0	60.0	86.0	4-10	M4-M10	E4-E8	6-10
949	64.0	67.0	108.0	4-10	M4-M10	E4-E8	6-10
972	83.0	70.0	102.0	4-16	M4-M16	E4-E12	6-12
6119	86.0	76.0	118.0	4-16	M4-M16	E4-E12	6-12
15092	45.0	35.0	45.0	4-6	M4-M6	E4	6
945	48.0	41.0	51.0	-	M4-M6	E4	6



Metric Dimensions without Fabric Reinforcement

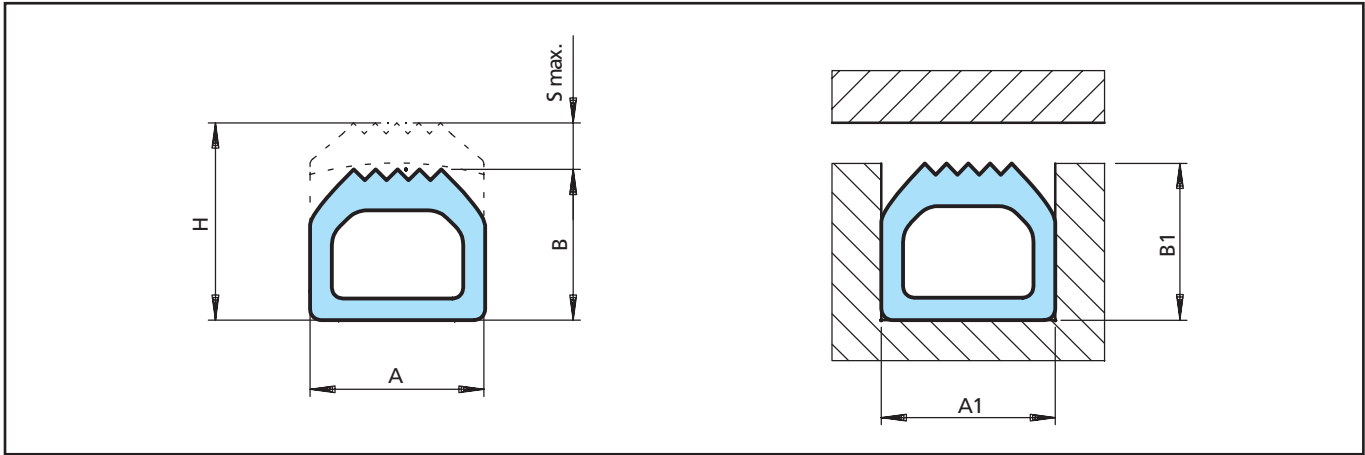

Figure 17 Standard high-pressure profile. metric

Table XVIII Dimensions and Profile Numbers

Profile Ref. No.		Groove Dimensions					
VMQ	EPDM	A x B	A1	B1	H	S max.	Max. Internal Pressure Pi MPa
973-5	973-6	6.5 x 5.0	6.5	5.5	6.5	1.5	0.1
971-5	971-6	16.0 x 14.0	16.0	15.5	17.5	3.5	0.5
969-5	969-6	20.0 x 20.0	20.0	21.5	24.0	4.0	0.6
970-5	970-6	21.0 x 24.0	21.0	26.0	29.0	5.0	0.7
942-5	-	54.0 x 40.0	54.0	42.0	48.0	8.0	1.0

Table XIX Recommended Minimum Radii and Valve Connections

Profile Ref. No.	Radii			Connections (min. - max.)			
	R axial	RO	RI	AC13-ø	AC10	AC12-ø	AC11-ø
973	19.0	22.0	26.0	4	M4	-	-
971	41.0	41.0	54.0	4-8	M4-M8	E4-E6	6-8
969	89.0	54.0	83.0	4-8	M4-M8	E4-E6	6-8
970	38.0	54.0	95.0	4-8	M4-M8	E4-E6	6-8
942	83.0	120.0	191.0	4-16	M4-M16	E4-E12	6-12



■ High Purity Inflatable Series

TSS is pleased to introduce the high purity series of inflatable seals, clamps, and actuators. The patent pending combines the use of advanced materials with a superior profile design to create a seal (bladder) that functions well under conditions where purity, cleanliness, and reliability are required. Features include:

Improved Sealing (Clamping/Actuating) Surface

After years of empirical testing coupled with a detailed design of experiments, our engineers have concluded that a large, continuous sealing surface will effect a better seal when compared to serrated designs. The high purity's flat „mesa-shaped“ profile is a result of this effort. For clamping and actuating, this design also improves the lbs-force generated as more surface area directly correlates to more force.

White, FDA-Compliant, High Performance Silicone

Our chemists have developed a high quality, white, FDA-compliant* silicone able to withstand the rigors of many inflation/deflation cycles. This material has proven to be comparable to other available materials yet adds the white, FDA-compliant component that is so important in clean room and pharmaceutical applications.

Low Outgassing**

Testing to date has shown a 91 % improvement in outgassing (total peak area) when compared to our standard silicones and a 98 % improvement over our competition. Use of this material will decrease the chance of contaminating controlled environments with unwanted chemical compounds.

Greater Gap Coverage

Although testing is still ongoing, we feel this type will reliably cover 10 % more gap than our current designs. For example, our new PR5993 profile will cover a maximum gap of 0.130" (3.3 mm) compared to PR15092 which covers 0.118" (3 mm).

Easier to Clean

When strict wash down procedures are required, these profiles make it easier to clean due to its smooth sealing surface, whereas multiple serrations could create contamination issues.

* meets 21CFR 177.2000. parts c, d, and e

** detailed outgassing study available upon request

Table XXII High Purity Inflatable Series Data

Profile	Compare to	B	H	Gap***	Std Air Connections
PRS991	PRS973	0.256 (6.5)	0.197 (5)	0.059 (1.5)	10, 11, 12, 13
PRS993	PR15092	0.551 (14)	0.394 (10)	0.118 (3)	10, 11, 12, 13
PRS995	PRS950	0.630 (16)	0.472 (12)	0.118 (3)	10, 11, 12, 13
PRS997	PRS970	0.827 (21)	0.945 (24)	0.197 (5)	10, 11, 12, 13
PRS999	PR6119	1.378 (35)	1.260 (32)	0.394 (10)	10, 11, 12, 13

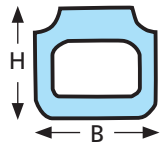

*** new gap conditions will be modified once testing is completed

Table XXIII Material Choice

Compound	Silicone 1	Silicone 2
Specific Gravity	1,178	1,166
Hardness (Shore A)	58	59
Tensile (psi)	1,382	1,378
Elongation (%)	744	671
100 % Modulus (psi)	265	284
Tear Strength, Die C, ppi	282	305
Total Peak Area	204	2,180
Cost	€€€	€€

Material	Total Peak Area
Silicone 1	204
Silicone 2	2,180
Competitor Material	10,236

Total Peak Area Determined Using Gas Chromatography TSS own test method



Airseal

■ End Plugs for High-pressure and Low-pressure Profiles

If the Airseal seal is not designed and employed as a closed geometric form, end plugs are required to close off the seal ends. These end plugs cannot be activated so that their profile height can be selected for the loaded or relieved state.

The standard design is to supply ends in the relieved state. Contact TSS to check tooling availability if loaded state ends are required.

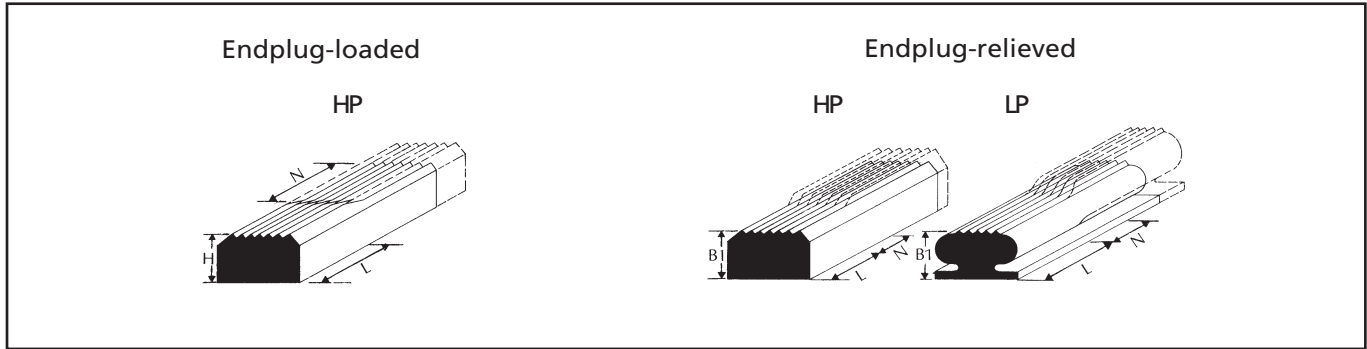

Figure 18 End plugs for metric profiles

Table XX End Plugs for Standard High-pressure Profiles

Profile Ref.No.		Profile Dimensions				
VMQ	EPDM	A x B	H	B1	L	N
15092-5	15092-6	14.0 x 10.0	13.0	11.0	14.0	5.0
950-5	950-6	16.0 x 12.0	15.0	13.0	16.0	5.0
960-5	960-6	16.0 x 18.0	21.5	19.5	16.0	5.0
955-5	955-6	22.0 x 19.0	22.5	20.5	22.0	6.0
952-5	952-6	26.0 x 19.0	23.5	20.5	26.0	7.0
949-5	972-6	27.0 x 21.0	26.0	23.0	27.0	7.0
972-5	-	35.0 x 26.0	34.0	29.0	35.0	9.0
6119-5	6119-6	35.0 x 32.0	45.0	35.0	35.0	9.0
973-5	-	6.5 x 5.0	6.5	5.5	6.5	2.0
971-5	971-6	16.0 x 14.0	17.5	15.5	16.0	4.0
969-5	969-6	20.0 x 20.0	24.0	21.5	20.0	5.0
970-5	970-6	21.0 x 24.0	29.0	26.0	21.0	6.0
942-5	-	54.0 x 40.0	48.0	42.0	54.0	14.0

Table XXI End Plugs for Standard Low-pressure Profiles

Profile Ref.No.		Profile Dimensions			
VMQ	EPDM	A x B	B1	L	N
951-5	951-6	30.0 x 20.0	20.0	20.0	15.0
9185-5	9185-6	40.0 x 27.0	27.0	25.0	20.0
946-5	946-6	60.0 x 35.0	35.0	40.0	30.0
974-5	974-6	90.0 x 55.0	55.0	60.0	45.0



■ End Plugs for Fabric Reinforced Profiles

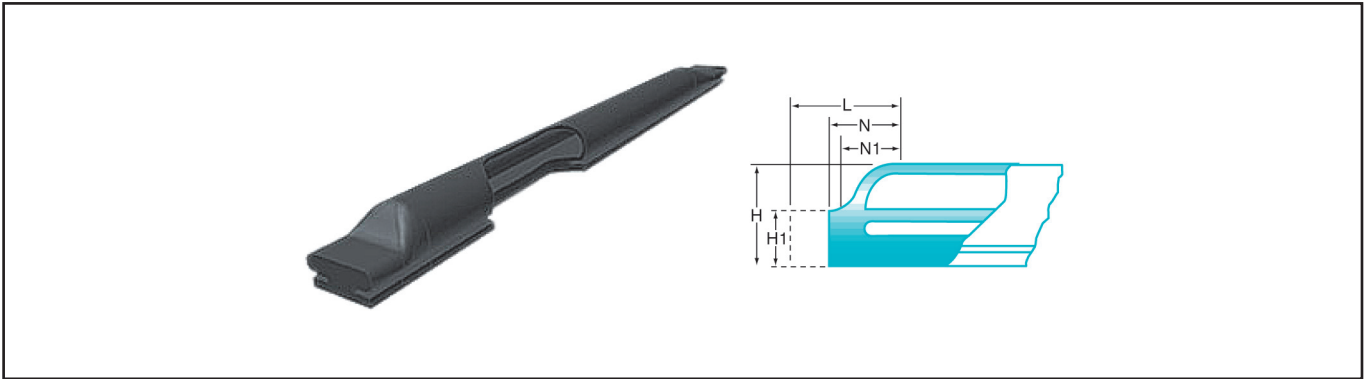

Figure 19 End plug design

Table XXIV End Plugs for Fabric Reinforced Standard Profiles

Profile Ref. No.				Profile Dimensions					
NBR	VMQ	CR	EPDM	A x B	N	L*	N1	H1	H
-	717-5	-	717-6	25.4 x 12.7	25.5	63.5	14.0	12.7	20.5
580-3	580-5	580-2	580-6	32.0 x 16.0	22.5	73.0	19.0	16.0	25.5
582-3	582-5	582-2	582-6	51.0 x 22.5	30.0	81.0	27.0	22.5	41.5
-	583-5	583-2	583-6	76.5 x 32.0	41.5	92.0	38.0	32.0	63.5
-	-	-	705-6	101.5 x 41.5	68.0	113.0	60.0	41.5	85.5
-	591-5	-	591-6	17.5 x 12.5	38.0	57.0	28.5	12.5	24.0
-	595-5	-	581-6	22.5 x 12.5	38.0	57.0	28.5	12.5	22.0
-	581-5	581-2	581-6	22.0 x 16.0	41.5	57.0	32.0	16.0	28.5
594-3	-	-	594-6	44.5 x 31.0	51.0	89.0	38.0	31.0	62.0
-	-	-	592-6	16.0 x 12.5	38.0	57.0	28.5	12.5	19.0
708-3	-	-	708-6	44.5 x 31.0	54.0	92.0	41.5	31.0	49.5
-	715-5	-	715-6	13.5 x 11.0	38.0	54.0	28.5	11.0	24.0
-	707-5	-	707-6	16.5 x 11.0	38.0	57.0	28.5	11.0	24.0

* Estimated dimensions

Ends of strip seals should be securely clamped as illustrated below.

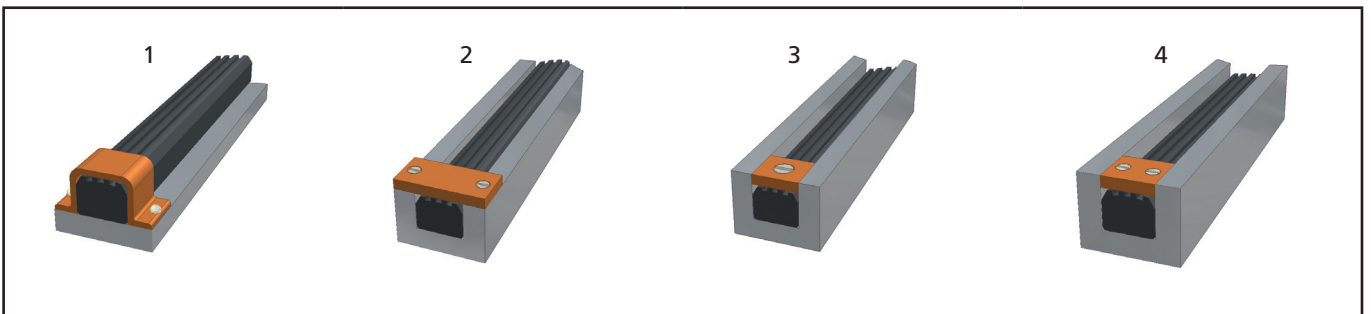



■ General Quality Criteria and Storage Guidelines

Quality criteria

The cost-effective use of seals and bearings is highly influenced by the quality criteria applied in production. Seals and bearings from Trelleborg Sealing Solutions are continuously monitored according to strict quality standards from material acquisition through to delivery.

Certification of our production plants in accordance with international standards QS 9000 / ISO 9000 meets the specific requirements for quality control and management of purchasing, production and marketing functions.

Our quality policy is consistently controlled by strict procedures and guidelines which are implemented within all strategic areas of the company.

All testing of materials and products is performed in accordance with accepted test standards and specifications, e.g. random sample testing in accordance with DIN ISO 2859, part 1.

Inspection specifications correspond to standards applicable to individual product groups (e.g. for O-Rings: ISO 3601).

Our sealing materials are produced free of chlorofluorinated hydrocarbons and carcinogenic elements.

The tenth digit of our part number defines the quality characteristics of the part. A hyphen indicates compliance with standard quality criteria outlined in this catalogue. Customer-specific requirements are indicated by a different symbol in this position. Customers who require special quality criteria should contact their local Trelleborg Sealing Solutions sales office for assistance. We have experience in meeting all Customer quality requirements.

Storage and shelf life

Seals and bearings are often stored as spare parts for prolonged periods. Most rubbers change in physical properties during storage and ultimately become unserviceable due, e.g., to excessive hardening, softening, cracking, crazing or other surface degradation. These changes may be the result of particular factors or combination of factors, such as the action of deformation, oxygen, ozone, light, heat, humidity or oils and solvents.

With a few simple precautions, the shelf life of these products can be considerably lengthened.

Fundamental instructions on storage, cleaning and maintenance of elastomeric seal elements are described in international standards, such as: DIN 7716 / BS 3F68:1977, ISO 2230 or DIN 9088.

The standards give several recommendations for the storage and the shelf life of elastomers, depending on the material classes.

The following recommendations are based on the several standards and are intended to provide the most suitable conditions for storage of rubbers. They should be observed to maintain the optimum physical and chemical values of the parts:

Heat

The storage temperature should preferably be between +5 °C and +25 °C. Direct contact with sources of heat such as boilers, radiators and direct sunlight should be avoided.

If articles are taken from low temperature storage, care should be taken to avoid distorting them during handling at that temperature as they may have stiffened. In this case the temperature of the articles should be raised to approximately +20 °C before they are put into service.

Humidity

The relative humidity in the store room should be below 70 %. Very moist or very dry conditions should be avoided. Condensation should not occur.

Light

Elastomeric seals should be protected from light sources, in particular direct sunlight or strong artificial light with an ultraviolet content. The individual storage bags offer the best protection as long as they are UV resistant.

It is advisable to cover any windows of storage rooms with a red or orange coating or screen.

Radiation

Precaution should be taken to protect stored articles from all sources of ionising radiation likely to cause damage to stored articles.

Oxygen and ozone

Where possible, elastomeric materials should be protected from circulating air by wrapping, storage in airtight containers or by other suitable means.

As ozone is particularly deleterious to some elastomeric seals, storage rooms should not contain any equipment that is capable of generating ozone, such as mercury vapour lamps, high voltage electrical equipment, electric motors or other equipment which may give rise to electric sparks or silent electrical discharges. Combustion gases and organic vapour should be excluded from storage rooms as they may give rise to ozone via photochemical processes.



Deformation

Elastomeric materials should, wherever possible, be stored in a relaxed condition free from tension, compression or other deformation. Where articles are packed in a strain-free condition they should be stored in their original packaging.

Contact with liquid and semi-solid materials

Elastomeric seals should not be allowed to come into contact with solvents, oils, greases or any other semi-solid materials at any time during storage, unless so packed by the manufacturer.

Contact with metal and non-metals

Direct contact with certain metals, e.g. manganese, iron and particularly copper and its alloys, e.g. brass and compounds of these materials are known to have deleterious effects on some rubbers. Elastomeric seals should not be stored in contact with such metals.

Because of possible transfer of plasticisers or other ingredients, rubbers must not be stored in contact with PVC. Different rubbers should preferably be separated from each other.

Cleaning

Where necessary, cleaning should be carried out with the aid of soap and water or methylated spirits. Water should not, however, be permitted to come into contact with fabric reinforced components, bonded seals (because of corrosion) or polyurethane rubbers. Disinfectants or other organic solvents as well as sharp-edged objects must not be used. The articles should be dried at room temperature and not placed near a source of heat. Clean room packing is available. Please contact TSS for further details.

Shelf life and shelf life control

The useful life of a elastomeric seals will depend to a large extent on the type of rubber. When stored under the recommended conditions (above sections) the below given shelf life of several materials should be considered.

NBR, HNBR, CR	6 years
EPDM	8 years
FKM, VMQ, FVMQ	10 years

Elastomeric seals should be inspected after the given period. After this giving an extension period is possible.

Rubber details and components less than 1.5 mm thick are liable to be more seriously affected by oxidation degradation even when stored in satisfactory conditions as recommended. Therefore they may be inspected and tested more frequently than it is mentioned above.

Rubber details / seals in assembled components

It is recommended that the units should be exercised at least every six months and that the maximum period a rubber detail be allowed to remain assembled within a stored unit, without inspection, be a total of the initial period stated above and the extension period. Naturally this will depend on the design of the unit concerned.



Engineering Action Request (EAR) for Airseal

TSS Project No.

We use your details to work out the optimum sealing recommendation. Your data will be confidential.

→ Please send back to:	
Name	_____
Fax no.	_____
Phone no.	_____

Company

Name _____

Street/P.O.Box _____

Post code/city _____

Country _____

Contact

Name _____

Departement _____

Title _____

Phone no. _____

Fax no. _____

Date, Signature _____

Profil no. _____

Material _____

Medium to seal _____

Approval required? _____

Advice: Our recommendation is based on your technical input. Missings details can lead to another sealing solution.

Differential pressure (environment / medium): ____ / ____

Operating temperature
max. _____ min. _____ duration _____

Valve adapter (selection see catalogue) _____

Application

Airseal will be used for
Sealing _____

Blending / Lifting of devices _____



Engineering Action Request (EAR) for Airseal

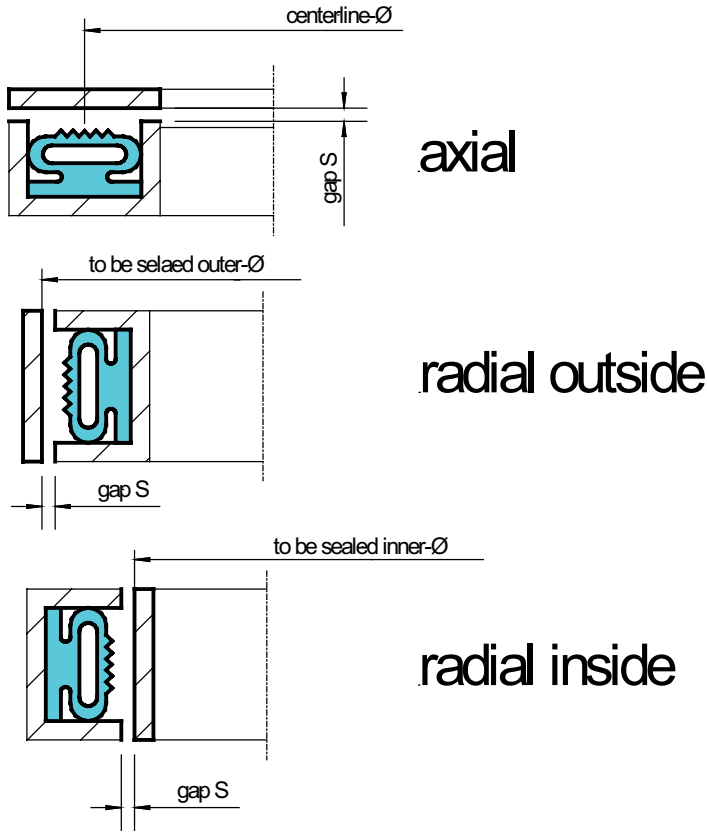

Type circular

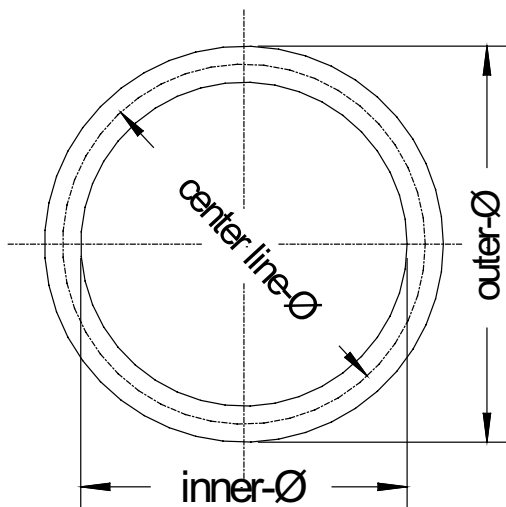

face seal:	_____
center line-Ø:	_____

inflate out:	_____
outer-Ø to be sealed:	_____

inflate in:	_____
inner-Ø to be sealed:	_____

gap S:	_____
--------	-------



Engineering Action Request (EAR) for Airseal

Type quadratic or rectangular, e.g. door seal

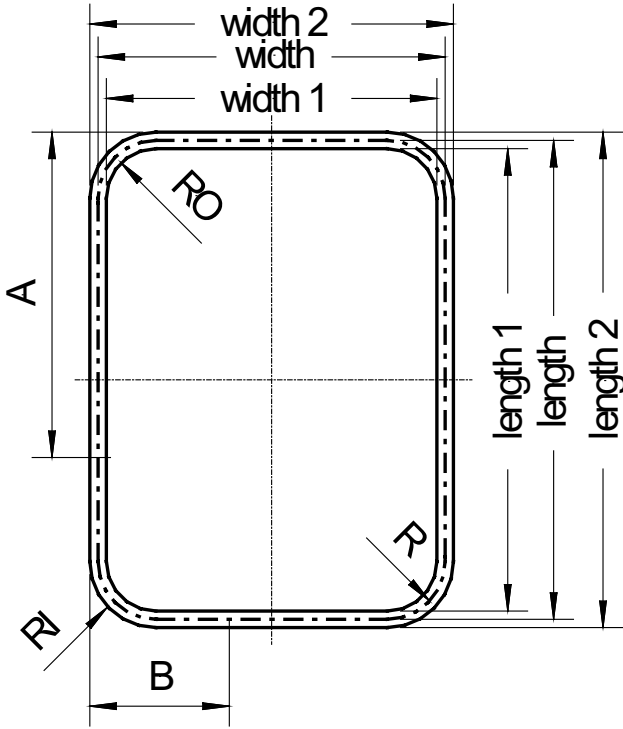

Width (face seal):	_____
Width 1 (inflate in):	_____
Width 2 (inflate out):	_____
Length (face seal):	_____
Length 1 (inflate in):	_____
Length 2 (inflate out):	_____
R (centerline-Ø):	_____
RI (inflate in):	_____
RO (inflate out):	_____
A:	_____
B:	_____
Gap S:	_____

Dimension A & B refer to the position of the valve seat. All dimensions refer to the devices, which are to be sealed. Radius R / RI / RO have to be conducted accordant to our remarks about minimum radius (see catalogue), rectangular types without radius could be possible after consulation.

Strip form with sealed ends



Engineering Action Request (EAR) for Airseal

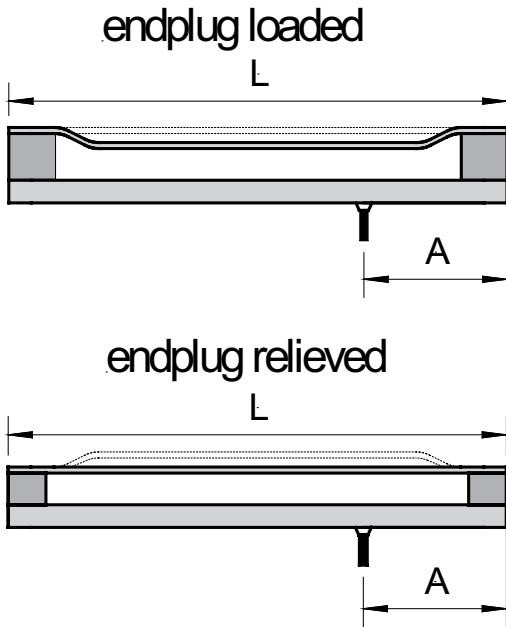

L: _____

A: _____

Dimension A defines the position of the valve adapter.

Seal loaded: _____

Seal relieved: _____

(more remarks see catalogue)

Sketch / Description of the application

Contact your local marketing company for further information:

Europe	Telephone	Americas	Telephone
AUSTRIA - Vienna (ALBANIA, BOSNIA AND HERZEGOVINA, MACEDONIA, SERBIA AND MONTENEGRO, SLOVENIA)	+43 (0) 1 406 47 33	AMERICAS - REGIONAL	+1 260 749 9631
BELGIUM - Dion-Valmont (LUXEMBOURG)	+32 (0) 10 22 57 50	BRAZIL - São Paulo	+55 11 3372 4500
BULGARIA - Sofia (BELARUS, ROMANIA, TURKEY, UKRAINE)	+359 (0)2 969 95 99	CANADA - Etobicoke, ON	+1 416 213 9444
CROATIA - Zagreb	+385 (0) 1 24 56 387	MEXICO - Mexico City	+52 55 57 19 50 05
CZECH REPUBLIC - Rakovník (SLOVAKIA)	+420 313 529 111	USA, East - Conshohocken, PA	+1 610 828 3209
DENMARK - Copenhagen	+45 48 22 80 80	USA, Great Lakes - Fort Wayne, IN	+1 260 482 4050
FINLAND - Vantaa (ESTONIA, LATVIA)	+358 (0) 207 12 13 50	USA, Midwest - Lombard, IL	+1 630 268 9915
FRANCE - Maisons-Laffitte	+33 (0) 1 30 86 56 00	USA, Mountain - Broomfield, CO	+1 303 469 1357
GERMANY - Stuttgart	+49 (0) 711 7864 0	USA, Northern California - Fresno, CA	+1 559 449 6070
GREECE	+41 (0) 21 631 41 11	USA, Northwest - Portland, OR	+1 503 595 6565
HUNGARY - Budaörs	+36 (06) 23 50 21 21	USA, South - N. Charleston, SC	+1 843 747 7656
ITALY - Livorno	+39 0586 22 6111	USA, Southwest - Houston, TX	+1 713 461 3495
THE NETHERLANDS - Barendrecht	+31 (0) 10 29 22 111	USA, West - Torrance, CA	+1 310 371 1025
NORWAY - Oslo	+47 22 64 60 80		
POLAND - Warsaw (LITHUANIA)	+48 (0) 22 863 30 11	Asia Pacific	Telephone
RUSSIA - Moscow	+7 495 982 39 21	ASIA PACIFIC REGIONAL	+65 6 577 1778
SPAIN - Madrid (PORTUGAL)	+34 (0) 91 71057 30	CHINA - Hong Kong	+852 2366 9165
SWEDEN - Jönköping	+46 (0) 36 34 15 00	CHINA - Shanghai	+86 (0) 21 6145 1830
SWITZERLAND - Crissier	+41 (0) 21 631 41 11	INDIA - Bangalore	+91 (0) 80 2245 5157
UNITED KINGDOM - Solihull (EIRE)	+44 (0) 121 744 1221	JAPAN - Tokyo	+81 (0) 3 5633 8008
AFRICA REGIONAL	+41 (0) 21 631 41 11	KOREA - Seoul	+82 (0) 2 761 3471
MIDDLE EAST REGIONAL	+41 (0) 21 631 41 11	MALAYSIA - Kuala Lumpur	+60 (0) 3 9059 6388
		TAIWAN - Taichung	+886 4 2382 8886
		THAILAND - Bangkok	+66 (0) 2732-2861
		SINGAPORE	
		and all other countries in Asia	+65 6 577 1778

www.tss.trelleborg.com