

For New Technology Network

NTN®

HAND

**ROLLING BEARINGS
HANDBOOK**

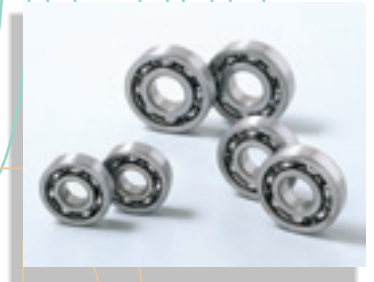

**HAND
BOOK**

CAT. No. 9012/E



NTN

Rolling Bearings Handbook

Introduction

When moving an object, friction force often comes into play, and must be surpassed to move the object. Various types of bearings are used to lessen this friction force for moving mechanisms such as machines.

The bearing gets its name from the fact that it bears a turning axle or shaft, but those parts used for sliding surfaces are also called bearings. Bearings include rolling bearings, which use balls, or rollers called "rolling elements."

The history of rolling bearings goes back a long time, but there has been striking technological progress in recent years. Such technological innovations have become an extremely important factor for various types of machines and equipment.

This Rolling Bearing Handbook provides a description of the fundamentals and proper use of rolling bearings in easy-to-understand terms. We hope you find this information helpful.

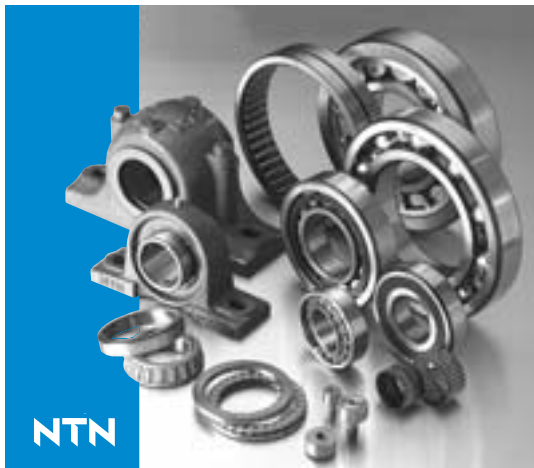

Contents

1	Rolling Bearings04	9	Bearing Internal Clearance and Preload45	1
	1.1 Sliding Friction and Rolling Friction04		9.1 Bearing Internal Clearance45	2
	1.2 Sliding Bearings and Rolling Bearings04		9.2 Internal Clearance Selection46	3
2	Classification and Characteristics of Rolling Bearings05	10	Allowable Speed53	4
	2.1 Rolling Bearing Construction05	11	Bearing Characteristics54	5
	2.2 Classification of Rolling Bearings06		11.1 Friction54	6
	2.3 Bearing Manufacturing Process08		11.2 Temperature Rise54	7
	2.4 Characteristics09		11.3 Sound55	8
3	Bearing Selection16	12	Lubrication57	9
	3.1 Selection Procedure16		12.1 Grease Lubrication57	10
	3.2 Types and Performance Comparison 17		12.2 Oil Lubrication62	11
	3.3 Bearing Arrangement18	13	External Bearing Sealing Devices65	12
4	Main Dimensions and Bearing Numbers19	14	Bearing Materials66	13
	4.1 Main Dimensions19		14.1 Raceway and Rolling Element Materials66	14
	4.2 Bearing Numbers20		14.2 Cage materials66	15
5	Bearing Precision22	15	Shaft and Housing Design67	16
	5.1 Dimension and Turning Precision22		15.1 Fixing of Bearings67	17
	5.2 Bearing Precision Measurement Methods 26		15.2 Bearing Fitting Dimensions68	18
6	Load Rating and Life27		15.3 Shaft and Housing Precision69	19
	6.1 Bearing Life27	16	Handling70	20
	6.2 Basic Rating Life and Basic Dynamic Load Rating27		16.1 Mounting70	21
	6.3 Adjusted Rating Life28		16.2 Post-Installation Running Test72	22
	6.4 Machine Applications and Requisite Life29		16.3 Bearing Removal72	23
	6.5 Basic Static Load Rating29		16.4 Press Fit and Pullout Force75	24
	6.6 Allowable Static Equivalent Load30	17	Bearing Damage and Corrective Measures76	25
7	Bearing Load32		NTN Electronic Catalog Operation Method82	26
	7.1 Load Used for Shafting32		Bearing Life Calculation Examples84	27
	7.2 Bearing Load Distribution34		Reference Material (Standard Symbols for Various Countries)90	28
	7.3 Equivalent Load36			29
	7.4 Allowable Axial Load37			30
8	Fits39			31
	8.1 Bearing Fits39			32
	8.2 Fit Selection40			33
	8.3 Fit Calculation42			34

1. Rolling Bearings

1.1 Sliding Friction and Rolling Friction

As shown in Fig. 1.1, the amount of force it takes to move an object of the same weight varies largely between the cases where the object is laid directly on the ground and pulled, and where the object is laid on rollers and pulled. This is because the coefficient of friction (μ) varies largely for these two cases.

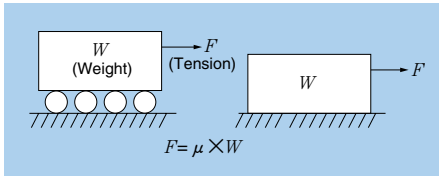

Fig. 1.1 Comparison of Friction Force

The force it takes to bring the object to the verge of moving can be calculated as $F = \mu \times W$, but the value of the coefficient of friction μ of a rolling bearing is a minute value of less than 1/100 that of a sliding bearing. The coefficient of friction of a rolling bearing is generally $\mu = 0.001$ to 0.005 .

1.2 Sliding Bearings and Rolling Bearings

There are various forms of each type of bearing, each having its own particular characteristics. If you compare the two, the general characteristics are as follows.

Characteristic	Rolling bearing	Sliding bearing
Construction	<p>Generally has inner and outer rings, in between which there are ball or roller rolling elements which support a rotating load by rolling.</p>	<p>Rotating load is supported by the surface, and makes direct sliding contact in some cases, or maintains sliding by film thickness using a fluid as a medium.</p>
Dimensions	Cross-sectional area is large due to intervention of rolling element.	Cross-sectional area is extremely small.
Friction	Friction torque is extremely small during rotation at start-up.	Friction torque is large at start-up, and may be small during rotation, depending on the conditions.
Internal clearance rigidity	Can be used by making internal clearance negative to provide rigidity as a bearing.	Used with clearance. Therefore, moves only the amount of the clearance.
Lubrication	As a rule, lubricant is required. Using grease, etc., facilitates maintenance; is sensitive to dirt.	Some types can be used without lubrication; generally speaking, are comparatively insensitive to dirt. Oil lubrication conditions require attention.
Temperature	Can be used from high to low temperatures. Cooling effect can be expected, depending on lubricant.	Generally speaking, there are high and low temperature limits.

Dimensions of rolling bearings have been internationally standardized. The bearings are widely used because they are interchangeable, easy to get, and inexpensive.

2. Classification and Characteristics of Rolling Bearings

2.1 Rolling Bearing Construction

Rolling bearings basically consist of four parts (outer ring, inner ring, rolling elements, cage). The shapes of parts of typical bearings are shown in Fig. 2.1.

● **Rolling bearing rings (inner and outer rings) or bearing washer** ①

The surface on which the rolling elements roll is referred to as the "raceway surface." The load placed on the bearings is supported by this contact surface. Generally speaking, the inner ring is used fitted on the shaft and the outer ring on the housing.

① In the new JIS (Japanese Industrial Standards), rolling bearing rings of thrust bearings are referred to as "rolling bearing

washers," the inner ring as "shaft washer," and the outer ring as "housing washer."

● **Rolling elements**

Rolling elements come in two general shapes: balls or rollers. Rollers come in four basic styles: cylindrical, needle, tapers and spherical. Rolling elements function to support the load while rolling on the bearing ring.

● **Cages**

Along with keeping the rolling elements in the correct position at a uniform pitch, cages also function to prevent the rolling elements from falling out. Cages include pressed cages pressed out of metal plating, precut machined cages, and resin formed cages.

Bearing type	Finished part	Part			
		Outer ring	Inner ring	Rolling elements	Cage
Deep groove ball bearing					
Cylindrical roller bearing					
Tapered roller bearing					
Self-aligning roller bearing					
Needle roller bearing					

Fig. 2.1 Comparison of Typical Rolling Bearings

2.2 Classification of Rolling Bearings

Rolling bearings are generally classified as shown in Fig. 2.2. In addition to these, there are bearings of various other shapes.

For more information, see the various NTN

catalogs. For terminology used for the parts of typical bearings, see Fig. 2.3.

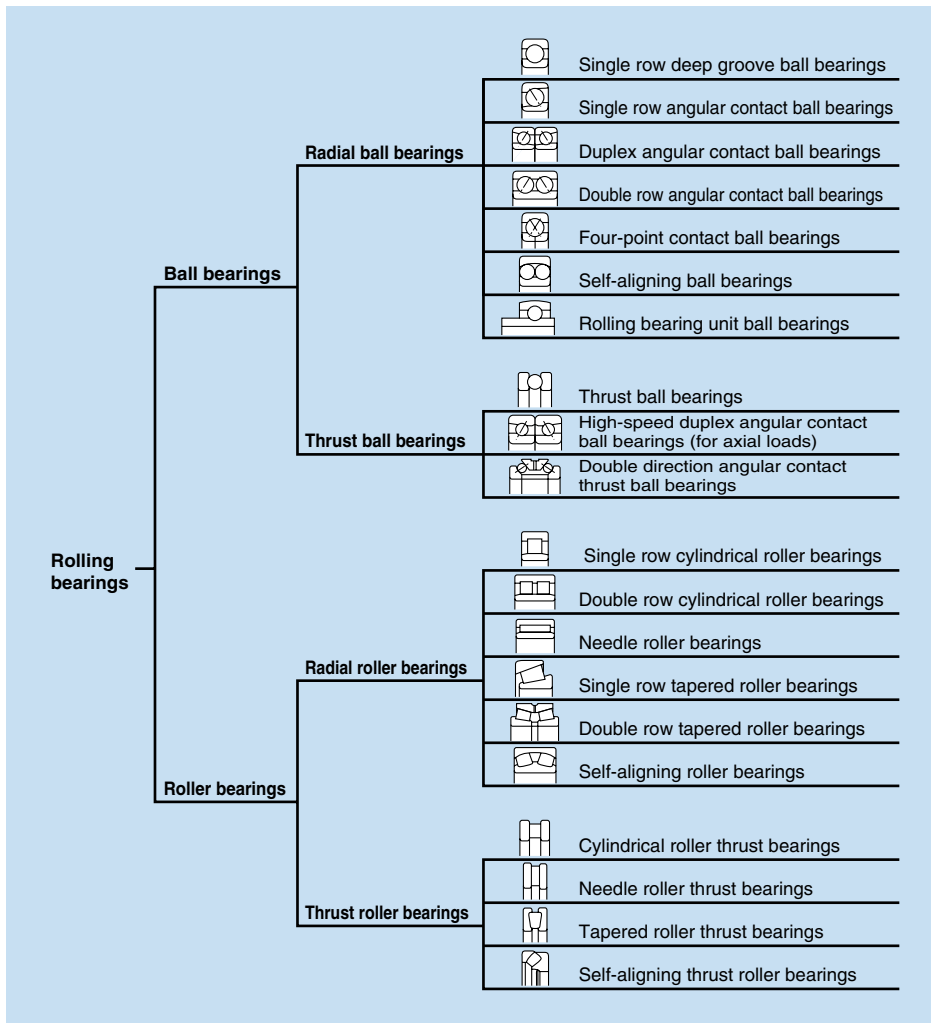

Fig. 2.2 Classification of Roller Bearings

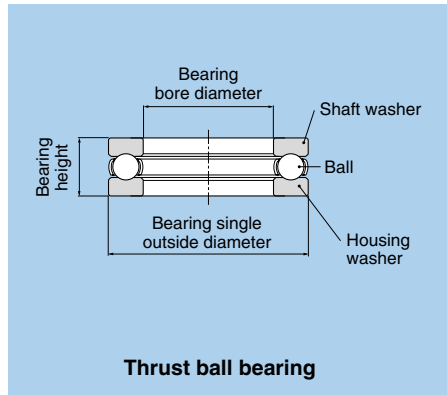
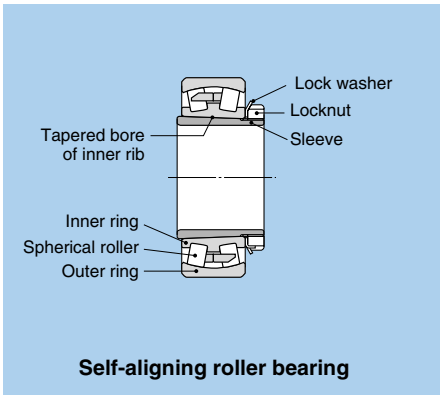
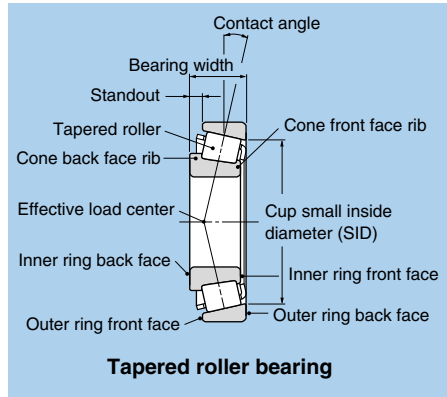
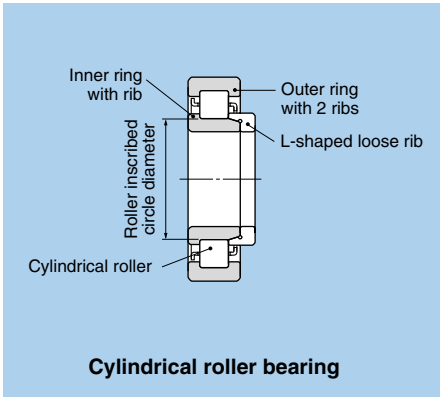
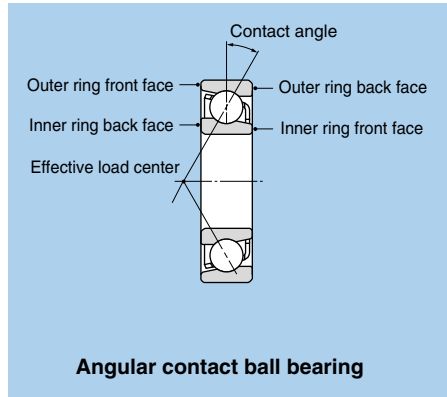
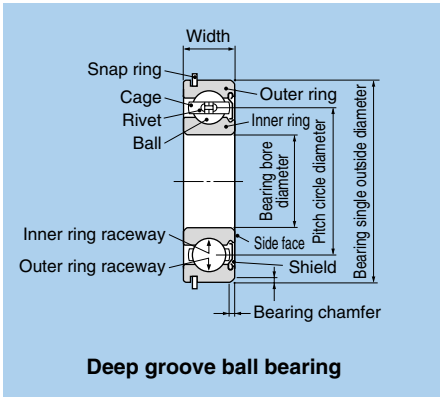

Fig. 2.3 Terminology of Bearing Parts

2.3 Bearing Manufacturing Process

There are many types of bearings, and manufacturing processes with many fine points of difference according to the type of bearing. Generally speaking, bearing

manufacturing consists of the processes of forging, turning, heat treatment, grinding, and assembly.

The manufacturing process for deep groove ball bearings is shown below.

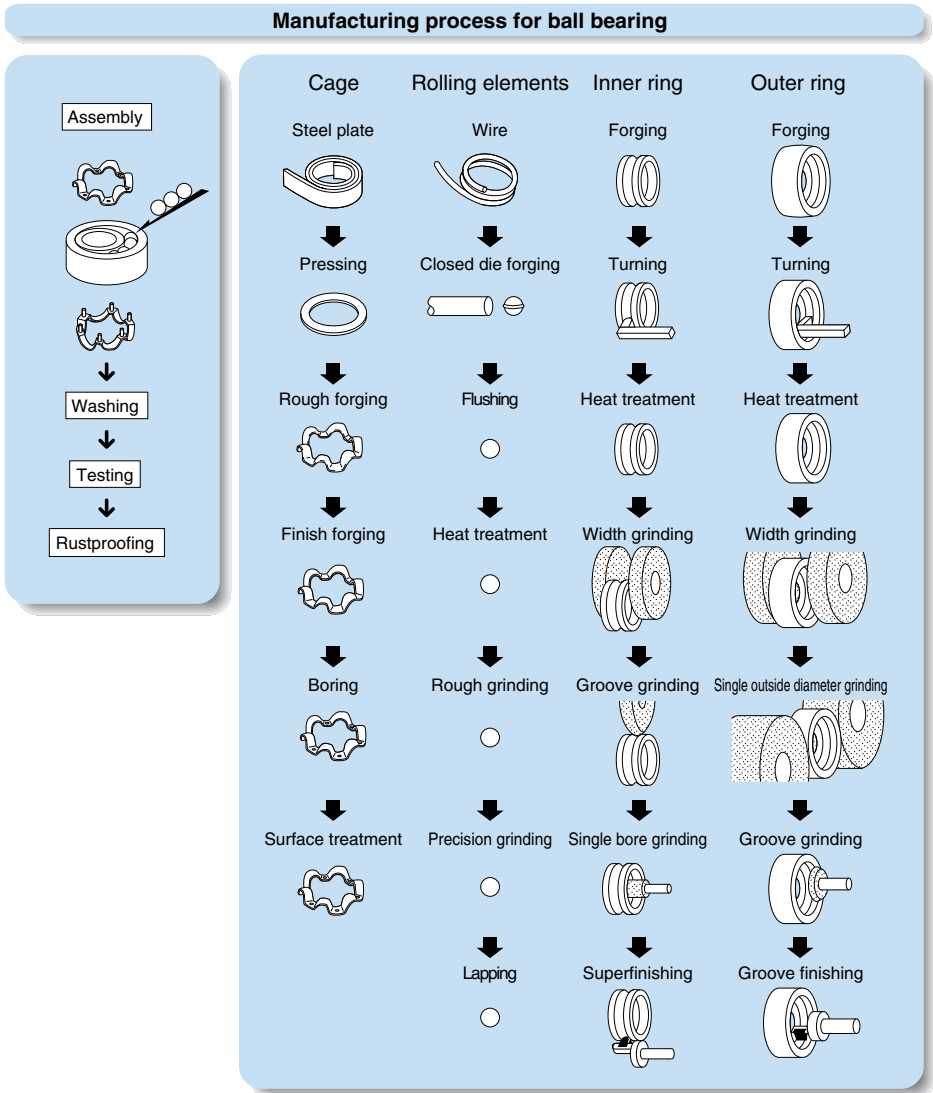
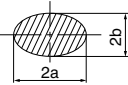
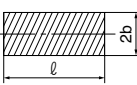

Fig. 2.4 Deep Groove Ball Bearing Manufacturing Process

2.4 Characteristics

• Ball bearings and roller bearings

Table 2.1 Comparison of Ball Bearings and Roller Bearings

	Ball bearings	Roller bearings
Contact with bearing ring	Point contact Contact surface becomes elliptical when a load is received. 	Line contact Contact surface generally becomes rectangular when a load is received. 
Characteristics	Balls make point contacts, so rolling resistance is slight, thus making it suitable for low torque, high-speed applications. Also has superior sound characteristics.	Because axial contact is made, rotation torque is less than that of balls, and rigidity is high.
Load capacity	Load capacity is small, so loads can be received in both radial and axial directions with radial bearings.	Load capacity is large. With cylindrical roller bearings with ribs, slight axial load can also be received. With tapered roller bearings, a combination of two bearings enables large axial load in both directions to be received.

• Deep Groove Ball Bearings

Widely used in a variety of fields, deep groove ball bearings are the most common type of bearing. Deep groove ball bearings may include seals or shields as shown in **Table 2.2**.

Deep groove ball bearings also include bearings with snap rings for positioning when

mounting the outer ring; expansion adjustment bearings which absorb dimension variation of the bearing fitting surface caused by temperature of the housing; and other various types of bearings such as TAB bearings which can withstand dirt in the lubrication oil.

Table 2.2 Construction and Characteristics of Sealed Ball Bearings

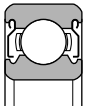
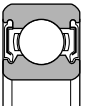
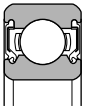
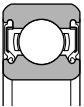
Type and symbol	Shielded type	Sealed type			
	Non-contact type ZZ	Non-contact type LLB	Contact type LLU	Low torque type LLH	
Construction					
	<ul style="list-style-type: none"> • A metal shield is fastened to the outer ring, forming a labyrinth clearance with the V-groove of the inner ring seal surface. 	<ul style="list-style-type: none"> • A seal plate of synthetic rubber anchored to a steel plate is fastened to the outer ring, and the edge of the seal forms a labyrinth clearance along the V-groove of the inner ring seal surface. 	<ul style="list-style-type: none"> • A seal plate of synthetic rubber anchored to a steel plate is fastened to the outer ring, and the edge of the seal makes contact with the side of the V-groove of the inner ring seal surface. 	<ul style="list-style-type: none"> • Basic construction is the same as the LU type, except the lip of the seal edge is specially designed with a slit to prevent absorption, forming a low-torque seal. 	
Performance comparison	Friction torque	Small	Small	Somewhat large	Medium
	Dustproof	Good	Better than ZZ type	Best	Better than LLB type
	Waterproof	Poor	Poor	Extremely good	Good
	High speed	Same as open type	Same as open type	Contact seal is limited	Better than LLU type
	Allowable temperature range ^①	-25°C~120°C	-25°C~120°C	-25°C~120°C	-25°C~120°C

① Allowable temperature range is indicated for standard product.

● **Angular Contact Ball Bearings**

The straight line that connects the inner ring, ball and outer ring runs at an angle (contact angle) to the radial direction. The angle is basically designed for three types of contact angle.

Angular contact ball bearings can bear an axial load. Since they however possess a contact angle, they cannot be used by themselves, but must rather be used in pairs or in combination. There is also a series that reconsiders internal design for high speed.

Angular Contact Ball Bearings

- Single and duplex arrangements 79
- High speed single and duplex arrangements
- Ultra-high speed angular contact ball bearings
- Ceramic ball angular contact ball bearings
- Four-point contact ball bearings QJ2
- Double row angular contact ball bearings

See page B-2 of the "Ball and Roller Bearings" catalog.



For more information, see the catalog.

There are double row angular contact ball bearings that contain the inner and outer rings all in one, instead of duplex bearings, and have 30°C contact angle.

Another bearing is the four-point contact ball bearing which can receive an axial load in both directions. Problems of temperature rise and friction however may occur depending upon load conditions.

Table 2.3 Contact Angle and Symbol

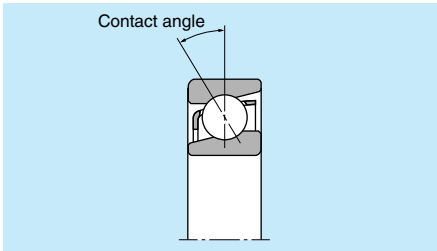

Contact Angle and Contact Angle Symbol

Contact angle	15°	30°	40°
Contact angle symbol	C	A ^①	B

① Contact angle symbol A is omitted in nomenclature.

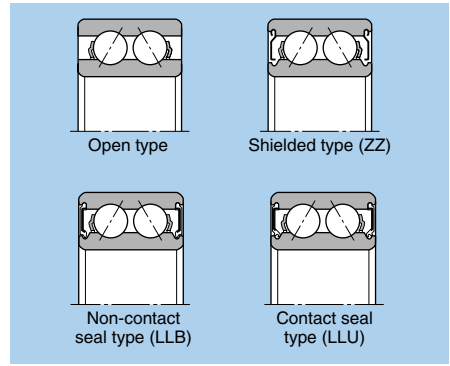

Fig. 2.5 Double Row Angular Contact Bearings

Table 2.4 Combinations Types and Characteristics of Duplex Angular Contact Bearings

Combination	Characteristics
Back-to-back duplex (DB)	<ul style="list-style-type: none"> ● Able to receive radial load and axial load in both directions. ● Distance l between load centers of bearings is large. Load capacity of moment load is consequently also large. ● Allowable inclination angle is small.
Face-to-face duplex bearing (DF)	<ul style="list-style-type: none"> ● Able to receive radial load and axial load in both directions. ● Distance l between load centers of bearings is small. Load capacity of moment load is consequently also small. ● Allowable inclination angle is larger than that of back-to-back duplex.
Tandem duplex bearing (DT)	<ul style="list-style-type: none"> ● Able to receive radial load and axial load in one direction. ● Receives axial load in tandem. Is consequently able to receive a large axial load.

Remarks 1. Bearings are made in sets in order to adjust preload and internal clearance of the bearing, so a combination of bearings having the same product number must be used.

● **Cylindrical Roller Bearings**

Because cylindrical roller bearings use rollers for rolling elements, load capacity is large, and the rollers are guided by the ribs of the inner and outer rings. The inner and outer rings can be separated to facilitate assembly, and tight fitting is possible for either. Types where either the inner or outer ring does not have a rib move freely in the direction of the shaft and therefore, are ideal for use as so-called "floating-side bearings" that absorb elongation of the shaft. Types with a rib, on the other hand, can receive

an axial load, albeit slight, between the roller end face and rib. In order to further enhance axial load capacity, there is the HT type that takes roller end face shape and rib into consideration, and the E-type cylindrical roller bearing with a special internal design for raising radial load capacity. The E-type is standard for small diameter size. Basic shape is given in **Table 2.5**.

Besides these, there are full complement SL bearings without cages and bearings with multiple rows of rollers suitable for even larger loads.

Table 2.5 Types and Characteristics of Cylindrical Roller Bearings

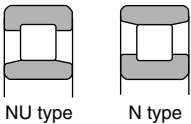
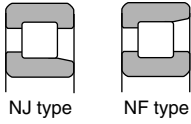
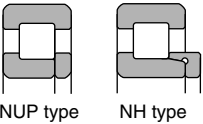
Bearing type symbol	Example	Characteristics
NU type N type	 <p>NU type N type</p>	<ul style="list-style-type: none"> ● The NU type has double ribs on the outer ring, and the outer ring / roller / cage assembly and inner ring can be separated. The N type has double ribs on the inner ring, and the inner ring / roller / cage assembly and outer ring can be separated. ● Cannot receive any axial load whatsoever. ● Most suitable types for floating side bearing; widely used.
NJ type NF type	 <p>NJ type NF type</p>	<ul style="list-style-type: none"> ● The NJ type has double ribs on the outer ring, and a single rib on the inner ring; the NF type has a single rib on the outer ring, and double ribs on the inner ring. ● Able to receive axial load in one direction. ● If fixed and floating sides are not differentiated, they may be used by placing two close together.
NUP type NH type (NJ + HJ)	 <p>NUP type NH type</p>	<ul style="list-style-type: none"> ● The NUP type has a loose rib mounted on the side of inner ring with no rib, and the NH type has an L-type loose rib mounted on the NJ type. The loose ribs can be separated, so the inner ring must be fixed in the axial direction. ● Able to receive an axial load in both directions. ● Sometimes used as a fixed side bearing.

Load Direction and Name

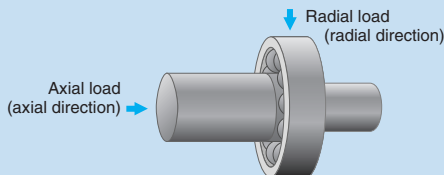

● **Tapered Roller Bearings**

The tapered vertex of the rollers and raceway surface of the outer and inner rings is designed to intersect a point on the centerline of the bearing. The rollers therefore are guided along the raceway surface by being pushed against the inner ring rib by synthetic power received from the outer and inner ring raceway surfaces.

Because component force is produced in the axial direction when a radial load is received, the bearings must be used in pairs. The outer and inner rings with rollers come

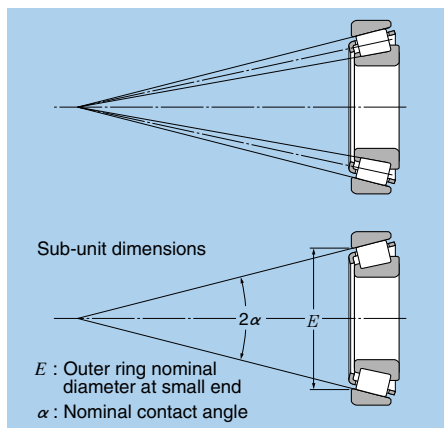

Fig. 2.6 Tapered Roller Bearing

apart, thus facilitating mounting with clearance and preload. It is however difficult to control the clearance. Tapered roller bearings are capable of receiving both large radial and axial loads.

NTN bearings with 4T-, ET-, T- and U conform to ISO and JIS sub-unit dimensions standards (contact angle, outer ring groove small diameter, outer ring width), and have international compatibility.

NTN offers bearings made of carburizing steel to extend life, such as ETA- and ET-bearings. We also have double row tapered roller bearings that combine two bearings, and heavy-duty four row tapered roller bearings.

● **Self-Aligning Roller Bearings**

Having an outer ring with a spherical raceway surface and an inner ring with a double row of barrel-shaped rolling elements, self-aligning roller bearings enable alignment of shaft inclination.

Types of self-aligning roller bearings differ according to internal design.

Some have a tapered inner ring bore to facilitate mounting on the shaft by adapter or withdrawal sleeve. The bearings are capable of receiving large loads and are therefore often used in industrial machinery. Single row rollers however bear no load when axial load becomes great, and are subject to various other problems.

Table 2.6 Types of Self-Aligning Roller Bearings



Type	Standard type (B type)	C type	213 type	E type
Construction				
Bearing series	Other than C type	Bore 50 mm or series (222, 223, 213) and 24024 - 24038	Single bore 55 mm or more (213)	22211 - 22218
Roller	Asymmetrical rollers	Symmetrical rollers	Asymmetrical rollers	Symmetrical rollers
Roller guide system	By center rib united with inner ring	By guide ring positioned between rows of rollers	By guide ring between rows of rollers positioned on the outer ring raceway	By high-precision cage (no center rib or guide ring)
Cage type	Pressed cage Machined cage	Pressed cage	Machined cage	Resin formed cage

● **Thrust Bearings**

There are various types of thrust bearings that differ according to application and shape of rolling elements. Allowable speed is generally low, and lubrication requires attention.

There are various types of thrust bearings for special applications besides those listed below. For more information, see the **NTN** catalogs.

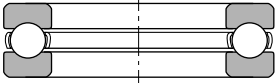
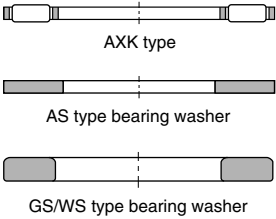
Table 2.7 Types and Characteristics of Thrust Bearings

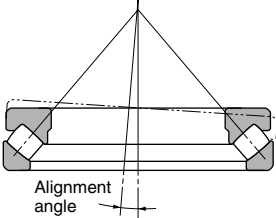
Type	Characteristics
<p>● Single-direction thrust ball bearing</p> 	<p>Has balls retained by a cage between the shaft washer (equivalent of inner ring) and housing washer (equivalent of outer ring), and is capable of receiving an axial load in one direction only.</p>
<p>● Needle roller thrust bearing</p>  <p>AXK type</p> <p>AS type bearing washer</p> <p>GS/WS type bearing washer</p>	<p>Some bearing washers use precut bearing washers, and some use bearing washers of pressed steel plate. Pressed bearing washers are used for bearings with the smallest cross-section height and large load capacity.</p>
<p>● Cylindrical roller thrust bearing</p> 	<p>The most common type uses a single row of cylindrical rollers, but some use two or three rows for larger load capacity.</p>
<p>● Self-aligning thrust roller bearing</p>  <p>Alignment angle</p>	<p>The raceway surface of the housing washer (outer ring) has a spherical surface that lines up with the bearing axis, and uses barrel shaped rolling elements to facilitate alignment. Self-aligning thrust roller bearings are capable of bearing large axial loads. The bearings have many sliding surfaces such as roller end faces and cages, and therefore requires lubricating oil even at low speeds.</p>

● **Needle Roller Bearings**

The needle-shaped rollers used as rolling elements have a diameter of 5 mm or less and length three to ten times the diameter. Because needle rollers are used as rolling elements, cross-section height is slight and load capacity is large for the dimensions. Because the bearing has many rolling

elements, rigidity is high, therefore it suitable for rocking motion.

There are many types of needle roller bearings, but here we shall introduce the most typical types only. For details, see the NTN catalog.

Table 2.8 Main Types and Characteristics of Needle Roller Bearings

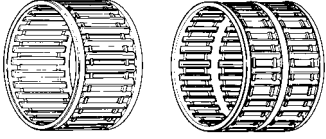
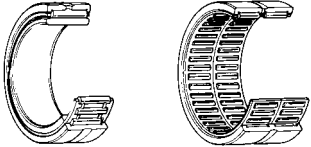
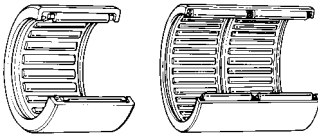
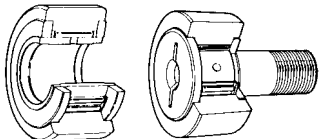
Type	Characteristics
<p>● Needle roller bearing with cage</p> 	<p>Most basic type of bearing, where the needle rollers are retained by the cage. Because the shaft and housing are directly used as the raceway surface, hardness and finish surface roughness require attention. There are various cage materials and shapes available.</p>
<p>● Machined ring needle roller bearing</p> 	<p>The basic shape is a precut outer ring attached to the previously described needle roller bearing with cage, and some are further equipped with an inner ring. In the case of a double rib type outer ring, there are many types where the cage is set in the bore diameter side and the needle rollers are inserted from the bore diameter. Some also come with seals.</p>
<p>● Drawn cup needle roller bearing</p> 	<p>With drawn cup needle roller bearings, the outer ring has a deep drawn steel plate and is press fit into the housing. Precision bore diameter shape of the housing affects the bearing performance as is. Housing precision therefore requires attention. The bearing on the other hand is retained by press fitting only, so it doesn't require snap rings, etc., thus enabling more economic design. This type includes sealed bearings and closed end bearings where one end is closed.</p>
<p>● Yoke type track rollers ● Stud type track rollers</p> 	<p>Bearing is used for rolling where the outer ring single outside diameter is made to come in direct contact with the counterpart material. There is no need to cover the outer ring with a tire, etc., thus enabling compact design. Wear life however varies according to operating conditions and hardness of counterpart material.</p>

● **Bearing Unit**

The unit that incorporates ball bearings inside housings of various shapes and sizes. The housing is mounted by bolting to the machine, and the shaft is simply attached to the inner ring by lock screw. This means that rotating equipment can be supported without any sort of special design in the periphery of the bearing. Standardized housing shapes

include pillow and flange types. The single outside diameter of the bearing is spherical, as is the bore diameter of the housing, to facilitate alignment.

Lubrication is sealed inside the bearing by grease; the double seal prevents dust from getting inside.

For more information concerning shapes, see the NTN catalog.

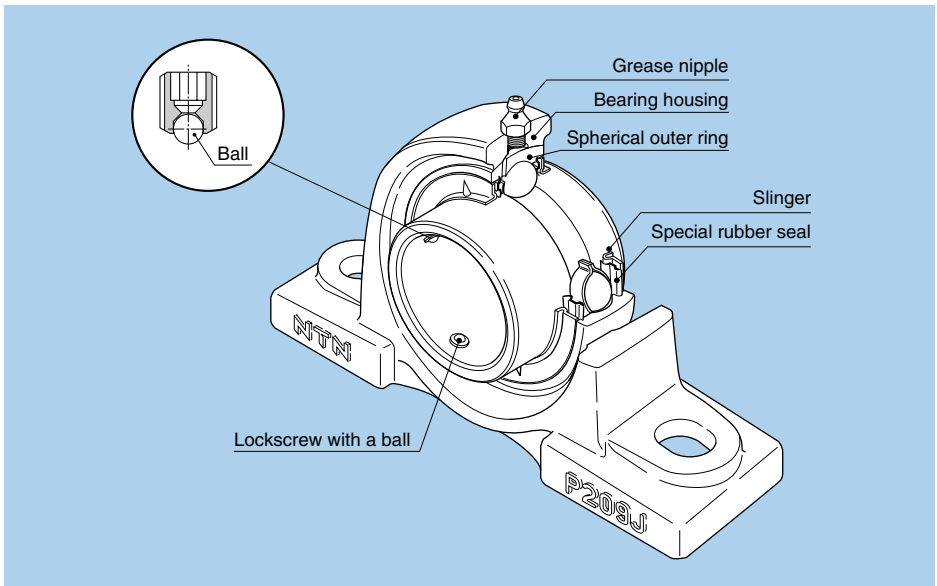

Fig. 2.7 Oiling Type Bearing Unit

3. Bearing Selection

3.1 Selection Procedure

Rolling bearings include many types and sizes. Selecting the best bearing is important for getting the machine or equipment to



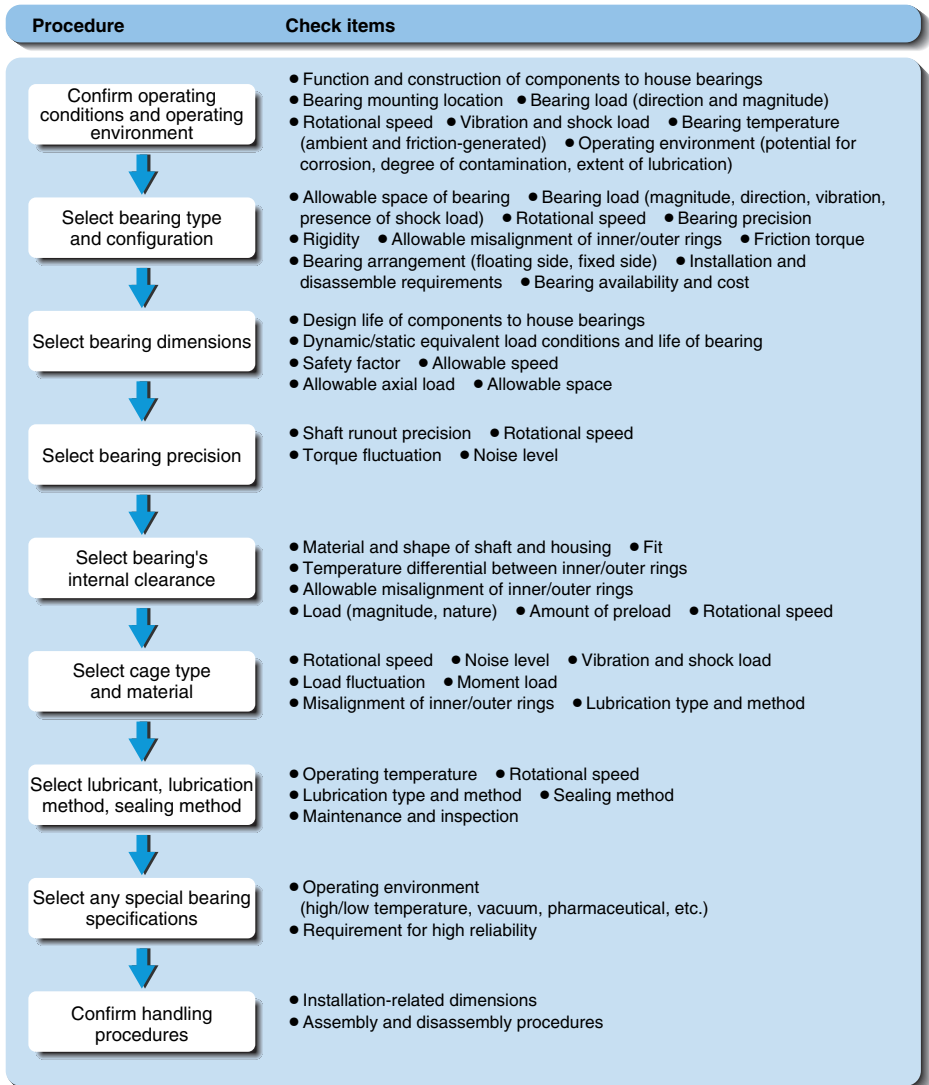











function in the way it's supposed to. There are various selection procedures, but the most common are shown in the following figure.



3.2 Types and Performance Comparison

A comparison of the performance of the main rolling bearings is given in the following table.

Table 3.1 Types and Performance of Rolling Bearings

Bearings types	Deep groove ball bearings	Angular contact ball bearings	Cylindrical roller bearings	Needle roller bearings	Tapered roller bearings	Self-aligning roller bearings	Thrust ball bearings
Characteristics							
Load carrying capacity							
High speed rotation ^①	☆☆☆☆	☆☆☆☆	☆☆☆☆	☆☆☆	☆☆☆	☆☆	☆
Low noise/vibration ^②	☆☆☆☆	☆☆☆	☆	☆			☆
Low friction torque ^②	☆☆☆☆	☆☆☆	☆				
High rigidity ^②			☆☆	☆☆	☆☆	☆☆☆	
Allowable misalignment for inner/outer rings ^②	☆					☆☆☆	★
Non-separable or separable ^③			○	○	○		○

① ☆ The number of stars indicates the degree to which that bearing type displays that particular characteristic.

★ Not applicable to that bearing type.

② ○ Indicates both inner ring and outer ring are detachable.

③ Some cylindrical roller bearings with rib can bear an axial load.



3.3 Bearing Arrangement

Shafts are generally supported by two bearings in the radial and axial directions. The side that fixes relative movement of the shaft and housing in the axial direction is called the "fixed side bearing," and the side that allows movement is called the "floating side bearing." The floating side bearing is needed to absorb mounting error and avoid stress caused by expansion and contraction of the shaft due to temperature change. In the case of bearings with detachable inner and outer rings such as

cylindrical and needle roller bearings, this is accomplished by the raceway surface. Bearings with non-detachable inner and outer rings, such as deep groove ball bearings and self-aligning roller bearings, are designed so that the fitting surface moves in the axial direction.

If bearing clearance is short, the bearings can be used without differentiating between the fixed and floating sides. In this case, the method of having the bearings face each other, such as with angular contact ball bearings and tapered roller bearings, is frequently used.

Table 3.2 (1) Sample Bearing Arrangement (fixed and floating sides differentiated)

Arrangement		Abstract	Application example (reference)
Fixed side	Floating side		
		<ol style="list-style-type: none"> 1. Typical arrangement for small machinery. 2. Capable of bearing a certain degree of axial load, as well as radial loads. 	Small pumps Automobile transmissions
		<ol style="list-style-type: none"> 1. Capable of bearing heavy loads. 2. You can enhance rigidity of shaft system by using back-to-back duplex bearing and applying preload. 3. Required improvement of shaft/housing precision and less mounting error. 	General industrial machinery Reduction gears
		<ol style="list-style-type: none"> 1. Frequently used in general industrial machinery for heavy loads and shock loads. 2. Able to tolerate a certain degree of mounting error and shaft flexure. 3. Capable of bearing radial loads and a certain degree of axial load in both directions. 	General industrial machinery Reduction gears

Table 3.2 (2) Sample Bearing Arrangement (fixed and floating sides not differentiated)

Arrangement		Abstract	Application example (reference)
			
		<ol style="list-style-type: none"> 1. Able to withstand heavy loads and shock loads, and has a wide range of use. 2. Rigidity can be enhanced by applying preload, but be careful not to apply too much preload. 3. Back mounting is suitable when moment load is produced, and front mounting when there is mounting error. 4. Front mounting facilitates mounting when the inner ring is tight-fitted. 	Reduction gears Front and rear axles of automobiles

4. Main Dimensions and Bearing Numbers

4.1 Main Dimensions

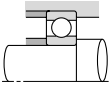
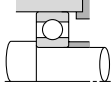
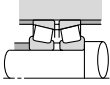
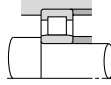
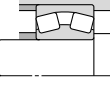
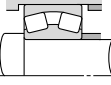
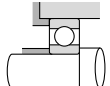
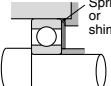
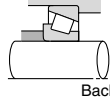
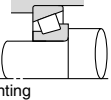
As shown in **Figs. 4.1 - 4.3**, main dimensions of rolling bearings include bearing bore diameter, single outside diameter, width/height, and chamfer. These dimensions must be known when mounting on the shaft and housing.

The main dimensions have been standardized by the International Standards

Organization (ISO), and the Japanese International Standard (JIS) is used in Japan.

The standard range of dimensions for single bore metric rolling bearings has been established as 0.6 - 2500 mm. For single bore, a code is used to express diameter series and width series, which indicate the size of the bearing cross-section.

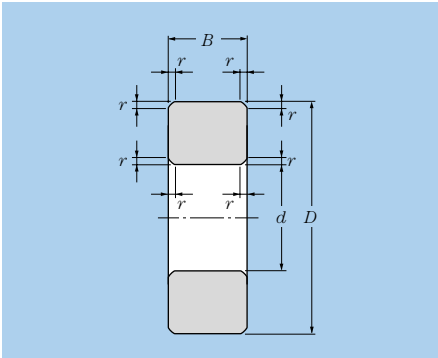

Fig. 4.1 Radial Bearing (tapered roller bearings not included)

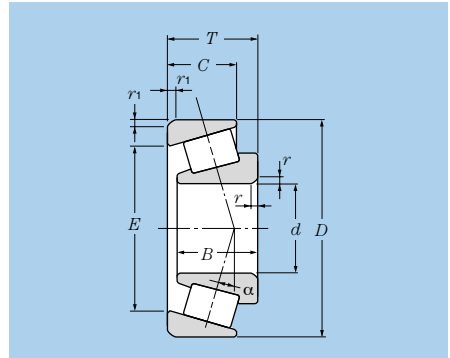

Fig. 4.2 Tapered Roller Bearing

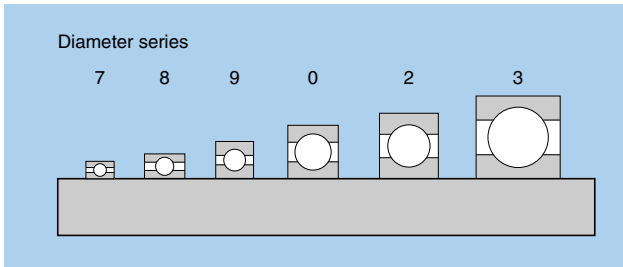

Fig. 4.3 Diameter Series of Radial Bearings

Table 4.1 Dimension Series Code

	Dimension series	
	Diameter series (outer dimension)	Width series (width dimension)
Radial bearing (tapered roller bearings not included)	Code	7. 8. 9. 0. 1. 2. 3. 4
	Dimension	Small ← → Large
Tapered roller bearing	Code	8. 0. 1. 2. 3. 4. 5. 6
	Dimension	Small ← → Large

4.2 Bearing Numbers

Bearing numbers indicate the type, dimensions, precision and internal construction of the bearing. Bearing numbers are comprised of a basic number and supplementary code. The arrangement sequence of bearing numbers is as shown in **Table 4.2**.

Special code contents are given in **Table 4.3**.



Table 4.2 Configuration and Arrangement Sequence of Bearing Numbers

Prefix supplementary code Special application / material / heat treatment code	Bearing series						Basic number		Contact angle code	
	Bearing series code	Dimension series code		Single bore number		Contact angle code		Code	Contact angle	
		Width/height Series	Diameter series	Code	Single bore mm	Code	Contact angle			
4T- 4T tapered roller bearing	Deep groove ball bearings (type code 6)			/0.6	0.6	Angular contact ball bearings				
ET- ET tapered roller bearing	67	(1)	7	/1.5	1.5	(A)	Standard contact angle 30°			
E- Bearing using cemented steel	68	(1)	8	/2.5	2.5	(B)	Standard contact angle 40°			
F- Bearing using stainless steel	69	(1)	9			(C)	Standard contact angle 15°			
H- Bearing using high-speed steel	60	(1)	0				Tapered roller bearings			
	62	(0)	2	1	1					
	63	(0)	3	:	:					
M- Plated bearing	Angular contact ball bearing (type code 7)			9	9	(B)	More than contact angle 10° and 17° or less			
	78	(1)	8							
	79	(1)	9							
5S- Bearing using ceramic rolling elements	70	(1)	0	00	10	(C)	More than contact angle 17° and 24° or less			
	72	(0)	2	01	12					
	73	(0)	3	02	15	(D)	More than contact angle 24° and 32° or less			
HL- Bearing using HL rollers	Cylindrical roller bearings (type code NU, N, NF, NNU, NN, etc.)									
TS2- High-temperature bearing treated for dimension stabilization (up to 160°C)	NU10	1	0	03	17					
	NU2	(0)	2							
	NU22	2	2							
	NU3	(0)	3	/22	22					
TS3- High-temperature bearing treated for dimension stabilization (up to 200°C)	NU23	2	3	/28	28					
	NU4	(0)	4	/32	32					
	NNU49	4	9	:	:					
	NN30	3	0							
TS4- High-temperature bearing treated for dimension stabilization (up to 250°C)	Tapered roller bearings (type code 3)			04	20					
	329X	2	9	05	25					
	320X	2	0	06	30					
	302	0	2							
	322	2	2							
	303	0	3	88	440					
	303D	0	3	92	460					
	313X	1	3	96	480					
	323	2	3							
	Self-aligning roller bearings (type code 2)									
	239	3	9	/500	500					
	230	3	0	/530	530					
	240	4	0	/560	560					
	231	3	1							
	241	4	1							
	222	2	2							
	232	3	2	/2 360	2 360					
	213	1	3	/2 500	2 500					
	223	2	3							

● Parentheses not displayed for bearing number.

Table 4.3 Bearing Number Arrangement

Bearing number arrangement			TS2-7 3 05 B L1 DF + 10 C3 P5										
Prefix supplementary code	Special application code												
	Material / heat treatment code												
Basic number	Bearing series	Type code											
		Dimensions series code	Width/height series code										
	Single bore No.												
	Contact angle code												
	Internal modification code												
Suffix supplementary code	Cage code												
	Seal/shield code												
	Bearing ring shape code												
	Combination code												
	Internal clearance code												
	Precision code												
	Lubrication code												

Suffix supplementary code							
Internal modification code	Cage code	Seal/shield code	Bearing ring shape code	Combination code	Internal clearance/preload code	Precision code	Lubrication
U Tapered roller bearing with international interchangeability	L1 High-strength brass machined cage	LLB With synthetic rubber seal (non-contact type)	K Standard taper single bore 1/12 taper hole	DB Back-to-back duplex 	C2 Smaller than normal clearance	P6 JIS Class 6	/2A Alvania 2
	F1 Carbon steel machined cage	LLU With synthetic rubber seal (contact type)	K30 Standard taper single bore 1/30 taper hole	DF Face-to-face duplex 	(CN) Normal clearance	P5 JIS Class 5	/3A Alvania 3
R Tapered roller bearing without international interchangeability	G1 High-strength brass rivetless cage with square holes	LLH With synthetic rubber seal (low-torque type)	N With ring groove	DT Tandem duplex	C3 Larger than normal clearance	P4 JIS Class 4	/8A Alvania EP2
	G2 Pin-type cage	ZZ With steel plate shield	D With oil hole	D2 Set of 2 of same type of bearing	C4 Larger than C3 clearance	-2 ABMA Class 2	/LX11 Barierta JFE552
ST Tapered roller bearing with low torque specifications	J Steel plate pressed cage		NR With snap ring	G Flush ground	C5 Larger than C4 clearance	-3 ABMA Class 3	/LP03 Solid grease (for polylyube bearing)
	T2 Resin formed cage				/GL Light preload		
					/GN Normal preload		
					/GM Medium preload		
					/GH Heavy preload		

Remarks: Contact NTN for bearing series codes and prefix/suffix supplementary codes not given in the table.

5. Bearing Precision

5.1 Dimension and Turning Precision

Dimension and turning precision are regulated by ISO and JIS standards.

Dimension precision

- Single bore, single outside diameter, width, assembled bearing width tolerance
- Chamfer dimensions, tapered hole tolerance

Shape precision

- Bore diameter variation, mean bore

diameter deviation, outside diameter variation, mean outside diameter variation

- Bearing ring width or height variation (in case of thrust bearing) tolerance

Turning precision

- Inner/outer ring radial and axial runout tolerance
- Inner ring face runout with bore tolerance
- Outer ring variation of outside surface generatrix inclination with face

5

Explanation of JIS Terminology

Because there are ambiguous expressions concerning dimension precision among those given in **Table 5.1**, an explanation of JIS terminology is provided below. (The terminology for outside surface is the same and has therefore been omitted.)

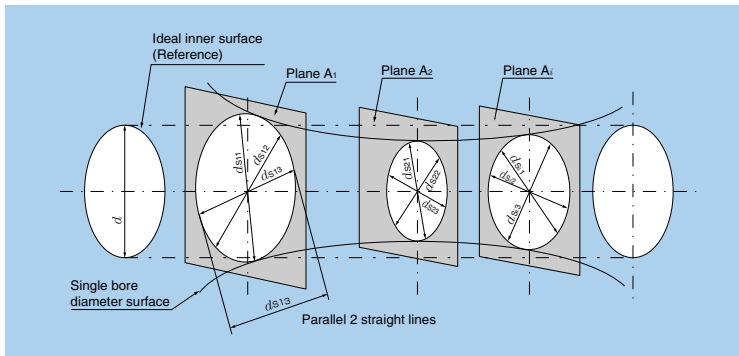

Shape Model Diagram

Nominal bore diameter d :

Reference dimension that expresses the size of a single bore diameter. Reference value for the dimension tolerance of the actual bore diameter surface.

Single bore diameter d_s :

Distance between two parallel straight lines that touch the intersecting line of the actual bearing bore diameter surface and radial plane.

Dimension tolerance of single bore diameter Δd_s :

Difference between d_s and d (difference between a single bore diameter and nominal bore diameter).

Single plane mean bore diameter d_{mp} :

In the arithmetic mean and model of the maximum and minimum values of a single bore diameter inside a single radial plane, concerning any radial plane A_i , if d_{s1} is the maximum single bore diameter and d_{s3} is the minimum, you get the value $(d_{s1} + d_{s3}) / 2$. Thus there is one value per plane.

With ISO492, ISO 199 (JIS B 1514), precision class is decided; with JIS 0 class (generally called "ordinary class"), precision increases in the order of class 6 → class 5 → class 4 → class 2. **Table 5.1** is a sample precision table for radial bearings.

There are various other standards besides ISO (JIS).

The most frequently requested ones are provided as a reference in the back of this handbook.

Mean bore diameter d_m :

In the model diagram, the arithmetic mean of the maximum and minimum values of a single bore diameters obtained from the entire cylinder surface, concerning the entire surface of planes $A_1A_2 \cdots A_i$, if d_{s11} is the maximum measurement value of the single bore diameter and the minimum value is d_{s23} , then $(d_{s11} + d_{s23})/2$ is the mean bore diameter, and has one value for one cylinder surface.

Dimension tolerance of mean bore diameter Δd_m :

Difference between the mean bore diameter and the nominal bore diameter.

Dimension tolerance of single plane mean bore diameter Δd_{mp} :

Difference between the nominal bore diameter and the arithmetic mean of the maximum and minimum values of a single bore diameter of a single radial plane. Value as prescribed by ISO 492, ISO 199 (JIS B 1514).

Bore diameter variation in a single radial plane V_{dp} :

In the model diagram, difference between the maximum and minimum values of a single bore diameter of a single radial plane. In radial plane A_1 , if d_{s11} is the maximum single bore diameter and d_{s13} is the minimum, we can obtain one value for the difference V_{dp} concerning the single plane. This characteristic could be thought of as an index for expressing roundness. Value as prescribed by ISO (JIS).

Mean bore diameter variation V_{dmp} :

Difference between the maximum and minimum values of a single plane mean bore diameter obtained for all planes. A unique value is obtained for each individual product. Expresses a type of cylindricity (differs from geometric cylindricity). Value as prescribed by ISO (JIS).

Nominal inner ring width B :

Theoretical distance between both sides of the bearing ring. In other words, the reference dimension for expressing the width of the bearing ring (distance between both sides).

Single inner ring width B_s :

Distance between the actual sides of the inner ring and both points of intersection of straight lines perpendicular to the plane that touches the reference side of the inner ring. Expresses the actual width dimension of the inner ring.

Dimension tolerance of single inner ring width ΔB_s :

Difference between the single inner ring width and the nominal inner ring width, and the difference between the actual inner ring width dimension and inner ring width. Value as prescribed by ISO (JIS).

Inner ring width variation V_{Bs} :

Difference between the maximum and minimum value of a single inner ring width. Value as prescribed by ISO (JIS).

Table 5.1 Tolerance for radial bearings (except tapered roller bearings)
(1) Inner rings

Nominal bore diameter <i>d</i> mm		Single plane mean bore diameter deviation Δ_{imp}								Single radial plane bore diameter deviation V_{ip}																
		over incl.		Class 0		Class 6		Class 5		Class 4 ^①		Class 2 ^①		Diameter series 9 Class 0,6,5,4,2			Diameter series 0,1 Class 0,6,5,4,2			Diameter series 2,3,4 Class 0,6,5,4,2						
				High	Low	High	Low	High	Low	High	Low	High	Low	High	Low	Max	Max	Max								
0.6 ^②	2.5	0	-8	0	-7	0	-5	0	-4	0	-2.5	10	9	5	4	2.5	8	7	4	3	2.5	6	5	4	3	2.5
2.5	10	0	-8	0	-7	0	-5	0	-4	0	-2.5	10	9	5	4	2.5	8	7	4	3	2.5	6	5	4	3	2.5
10	18	0	-8	0	-7	0	-5	0	-4	0	-2.5	10	9	5	4	2.5	8	7	4	3	2.5	6	5	4	3	2.5
18	30	0	-10	0	-8	0	-6	0	-5	0	-2.5	13	10	6	5	2.5	10	8	5	4	2.5	8	6	5	4	2.5
30	50	0	-12	0	-10	0	-8	0	-6	0	-2.5	15	13	8	6	2.5	12	10	6	5	2.5	9	8	6	5	2.5
50	80	0	-15	0	-12	0	-9	0	-7	0	-4	19	15	9	7	4	19	15	7	5	4	11	9	7	5	4
80	120	0	-20	0	-15	0	-10	0	-8	0	-5	25	19	10	8	5	25	19	8	6	5	15	11	8	6	5
120	150	0	-25	0	-18	0	-13	0	-10	0	-7	31	23	13	10	7	31	23	10	8	7	19	14	10	8	7
150	180	0	-25	0	-18	0	-13	0	-10	0	-7	31	23	13	10	7	31	23	10	8	7	19	14	10	8	7
180	250	0	-30	0	-22	0	-15	0	-12	0	-8	38	28	15	12	8	38	28	12	9	8	23	17	12	9	8
250	315	0	-35	0	-25	0	-18	—	—	—	—	44	31	18	—	—	44	31	14	—	—	26	19	14	—	—
315	400	0	-40	0	-30	0	-23	—	—	—	—	50	38	23	—	—	50	38	18	—	—	30	23	18	—	—
400	500	0	-45	0	-35	—	—	—	—	—	—	56	44	—	—	—	56	44	—	—	—	34	26	—	—	—
500	630	0	-50	0	-40	—	—	—	—	—	—	63	50	—	—	—	63	50	—	—	—	38	30	—	—	—
630	800	0	-75	—	—	—	—	—	—	—	—	94	—	—	—	—	94	—	—	—	—	55	—	—	—	—
800	1 000	0	-100	—	—	—	—	—	—	—	—	125	—	—	—	—	125	—	—	—	—	75	—	—	—	—
1 000	1 250	0	-125	—	—	—	—	—	—	—	—	155	—	—	—	—	155	—	—	—	—	94	—	—	—	—
1 250	1 600	0	-160	—	—	—	—	—	—	—	—	200	—	—	—	—	200	—	—	—	—	120	—	—	—	—
1 600	2 000	0	-200	—	—	—	—	—	—	—	—	250	—	—	—	—	250	—	—	—	—	150	—	—	—	—

① Tolerance of the inner bore dimensional difference Δ_{is} which applies to classes 4 and 2 is the same as the tolerance of dimensional difference Δ_{imp} of the mean bore diameter. Diameter series' 0, 1, 2, 3 and 4 however apply to class 4, while all series' apply to class 2.

(2) Outer ring

Nominal outside diameter <i>D</i> mm		Single plane mean outside diameter deviation Δ_{imp}								Single radial plane outside diameter variation ^③ V_{ip}																
		over incl.		Class 0		Class 6		Class 5		Class 4 ^③		Class 2 ^③		Diameter series 9 Class 0,6,5,4,2			Diameter series 0.1 Class 0,6,5,4,2			Diameter series 2,3,4 Class 0,6,5,4,2						
				High	Low	High	Low	High	Low	High	Low	High	Low	High	Low	Max	Max	Max								
2.5 ^②	6	0	-8	0	-7	0	-5	0	-4	0	-2.5	10	9	5	4	2.5	8	7	4	3	2.5	6	5	4	3	2.5
6	18	0	-8	0	-7	0	-5	0	-4	0	-2.5	10	9	5	4	2.5	8	7	4	3	2.5	6	5	4	3	2.5
18	30	0	-9	0	-8	0	-6	0	-5	0	-4	12	10	6	5	4	9	8	5	4	4	7	6	5	4	4
30	50	0	-11	0	-9	0	-7	0	-6	0	-4	14	11	7	6	4	11	9	5	5	4	8	7	5	5	4
50	80	0	-13	0	-11	0	-9	0	-7	0	-4	16	14	9	7	4	13	11	7	5	4	10	8	7	5	4
80	120	0	-15	0	-13	0	-10	0	-8	0	-5	19	16	10	8	5	19	16	8	6	5	11	10	8	6	5
120	150	0	-18	0	-15	0	-11	0	-9	0	-5	23	19	11	9	5	23	19	8	7	5	14	11	8	7	5
150	180	0	-25	0	-18	0	-13	0	-10	0	-7	31	23	13	10	7	31	23	10	8	7	19	14	10	8	7
180	250	0	-30	0	-20	0	-15	0	-11	0	-8	38	25	15	11	8	38	25	11	8	8	23	15	11	8	7
250	315	0	-35	0	-25	0	-18	0	-13	0	-8	44	31	18	13	8	44	31	14	10	8	26	19	14	10	8
315	400	0	-40	0	-28	0	-20	0	-15	0	-10	50	35	20	15	10	50	35	15	11	10	30	21	15	11	10
400	500	0	-45	0	-33	0	-23	—	—	—	—	56	41	23	—	—	56	41	17	—	—	34	25	17	—	—
500	630	0	-50	0	-38	0	-28	—	—	—	—	63	48	28	—	—	63	48	21	—	—	38	29	21	—	—
630	800	0	-75	0	-45	0	-35	—	—	—	—	94	56	35	—	—	94	56	26	—	—	55	34	26	—	—
800	1 000	0	-100	0	-60	—	—	—	—	—	—	125	75	—	—	—	125	75	—	—	—	75	45	—	—	—
1 000	1 250	0	-125	—	—	—	—	—	—	—	—	155	—	—	—	—	155	—	—	—	—	94	—	—	—	—
1 250	1 600	0	-160	—	—	—	—	—	—	—	—	200	—	—	—	—	200	—	—	—	—	120	—	—	—	—
1 600	2 000	0	-200	—	—	—	—	—	—	—	—	250	—	—	—	—	250	—	—	—	—	150	—	—	—	—
2 000	2 500	0	-250	—	—	—	—	—	—	—	—	310	—	—	—	—	310	—	—	—	—	190	—	—	—	—

③ Tolerance of the outside diameter dimensional difference Δ_{os} which applies to classes 4 and 2 is the same as the tolerance of dimensional difference Δ_{imp} of the mean bore diameter. Diameter series' 0, 1, 2, 3 and 4 however apply to class 4, while all series' apply to class 2.

Unit: μm

Mean single plane bore diameter variation V_{amp} Class 0,6,5,4,2 Max	Inner ring radial runout K_{ra} Class 0,6,5,4,2 Max	Face runout with bore S_d Class 5,4,2 Max	Inner ring ^② axial runout (with side) S_{ia} Class 5,4,2 Max	Deviation of a single inner ring width Δ_{rs}								Inner ring width variation V_{rs} Class 0,6,5,4,2 Max		
				Normal				Modified ^③						
				Class 0,6	Class 5,4	Class 2		Class 0,6,5,4,						
				High	Low	High	Low	High	Low					
6 5 3 2 1.5	10 5 4 2.5 1.5	7 3 1.5	7 3 1.5	0	-40	0	-40	0	-40	-	-	0	-250	12 12 5 2.5 1.5
6 5 3 2 1.5	10 6 4 2.5 1.5	7 3 1.5	7 3 1.5	0	-120	0	-40	0	-40	0	-250	0	-250	15 15 5 2.5 1.5
6 5 3 2 1.5	10 7 4 2.5 1.5	7 3 1.5	7 3 1.5	0	-120	0	-80	0	-80	0	-250	0	-250	20 20 5 2.5 1.5
8 6 3 2.5 1.5	13 8 4 3 2.5	8 4 1.5	8 4 2.5	0	-120	0	-120	0	-120	0	-250	0	-250	20 20 5 2.5 1.5
9 8 4 3 1.5	15 10 5 4 2.5	8 4 1.5	8 4 2.5	0	-120	0	-120	0	-120	0	-250	0	-250	20 20 5 3 1.5
11 9 5 3.5 2	20 10 5 4 2.5	8 5 1.5	8 5 2.5	0	-150	0	-150	0	-150	0	-380	0	-250	25 25 6 4 1.5
15 11 5 4 2.5	25 13 6 5 2.5	9 5 2.5	9 5 2.5	0	-200	0	-200	0	-200	0	-380	0	-380	25 25 7 4 2.5
19 14 7 5 3.5	30 18 8 6 2.5	10 6 2.5	10 7 2.5	0	-250	0	-250	0	-250	0	-500	0	-380	30 30 8 5 2.5
19 14 7 5 3.5	30 18 8 6 5	10 6 4	10 7 5	0	-250	0	-250	0	-300	0	-500	0	-380	30 30 8 5 4
23 17 8 6 4	40 20 10 8 5	11 7 5	13 8 5	0	-300	0	-300	0	-350	0	-500	0	-500	30 30 10 6 5
26 19 9 - -	50 25 13 - -	13 - -	15 - -	0	-350	0	-350	-	-	0	-500	0	-500	35 35 13 - -
30 23 12 - -	60 30 15 - -	15 - -	20 - -	0	-400	0	-400	-	-	0	-630	0	-630	40 40 15 - -
34 26 - - -	65 35 - - -	- - -	- - -	0	-450	-	-	-	-	-	-	-	-	50 45 - - -
38 30 - - -	70 40 - - -	- - -	- - -	0	-500	-	-	-	-	-	-	-	-	60 50 - - -
55 - - - -	80 - - - -	- - -	- - -	0	-750	-	-	-	-	-	-	-	-	70 - - - -
75 - - - -	90 - - - -	- - -	- - -	0	-1 000	-	-	-	-	-	-	-	-	80 - - - -
94 - - - -	100 - - - -	- - -	- - -	0	-1 250	-	-	-	-	-	-	-	-	100 - - - -
120 - - - -	120 - - - -	- - -	- - -	0	-1 600	-	-	-	-	-	-	-	-	120 - - - -
150 - - - -	140 - - - -	- - -	- - -	0	-2 000	-	-	-	-	-	-	-	-	140 - - - -

② Applies to deep groove bearings and ball bearings such as angular contact ball bearings.

③ Applies to individual raceways made to use with duplex bearings. ① 0.6 mm is included in the dimensional division.

Unit: μm

Single radial plane outside diameter variation V_{Dp} Capped bearings Diameter series Class 2,3,4,0 0,1,2,3,4,6 Max	Mean single plane outside diameter variation V_{Dmp} Class 0,6,5,4,2 Max	Outer ring radial runout K_{ra} Class 0,6,5,4,2 Max	Variation of outside surface generatrix inclination with face S_{Df} Class 5,4,2 Max	Outside ring ^③ axial runout S_{oa} Class 5,4,2 Max	Deviation of a single inner ring width Δ_{rs} All type	Inner ring width variation V_{rs}	
						Class 0,6	Class 5,4,2
						Max	Max
10 9	6 5 3 2 1.5	15 8 5 3 1.5	8 4 1.5	8 5 1.5	Depends on tolerance of Δ_{rs} relative to d of same bearing.	Depends on tolerance of V_{rs} relative to d of same bearing.	5 2.5 1.5
10 9	6 5 3 2 1.5	15 8 5 3 1.5	8 4 1.5	8 5 1.5			5 2.5 1.5
12 10	7 6 3 2.5 2	15 9 6 4 2.5	8 4 1.5	8 5 2.5			5 2.5 1.5
16 13	8 7 4 3 2	20 10 7 5 2.5	8 4 1.5	8 5 2.5			5 2.5 1.5
20 16	10 8 5 3.5 2	25 13 8 5 4	8 4 1.5	10 5 4			6 3 1.5
26 20	11 10 5 4 2.5	35 18 10 6 5	9 5 2.5	11 6 5			8 4 2.5
30 25	14 11 6 5 2.5	40 20 11 7 5	10 5 2.5	13 7 5			8 5 2.5
38 30	19 14 7 5 3.5	45 23 13 8 5	10 5 2.5	14 8 5			8 5 2.5
- -	23 15 8 6 4	50 25 15 10 7	11 7 4	15 10 7			10 7 4
- -	26 19 9 7 4	60 30 18 11 7	13 8 5	18 10 7			11 7 5
- -	30 21 10 8 5	70 35 20 13 8	13 10 7	20 13 8	13 8 7		
- -	34 25 12 - -	80 40 23 - -	15 - -	23 - -	15 - -		
- -	38 29 14 - -	100 50 25 - -	18 - -	25 - -	18 - -		
- -	55 34 18 - -	120 60 30 - -	20 - -	30 - -	20 - -		
- -	75 45 - - -	140 75 - - -	- - -	- - -	- - -		
- -	94 - - - -	160 - - - -	- - -	- - -	- - -		
- -	120 - - - -	190 - - - -	- - -	- - -	- - -		
- -	150 - - - -	220 - - - -	- - -	- - -	- - -		
- -	190 - - - -	250 - - - -	- - -	- - -	- - -		

③ Applies when snap ring is not mounted. ① Applies to deep groove bearings and ball bearings such as angular contact ball bearings.

② 2.5 mm is included in the dimensional division.

5.2 Bearing Precision Measurement Methods

The figure shows difficult-to-understand turning precision measurement methods only.

Table 5.2 Bearing Precision Measurement Methods

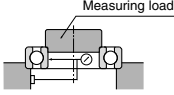
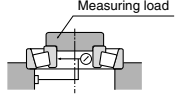
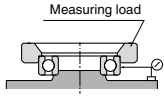
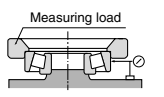
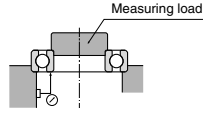
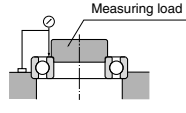
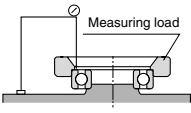
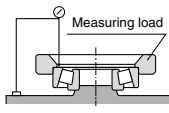
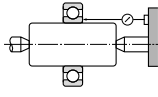
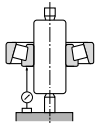
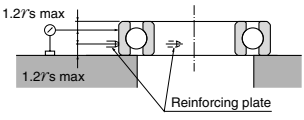
Precision characteristics	Measurement method		
Inner ring radial runout (K_{ia})			For inner ring radial runout, record the difference between the maximum and minimum reading of the measuring device when the inner ring is turned one revolution.
Outer ring radial runout (K_{ea})			For outer ring radial runout, record the difference between the maximum and minimum reading of the measuring device when the outer ring is turned one revolution.
Inner ring axial runout (S_{ia})			For inner ring axial runout, record the difference between the maximum and minimum reading of the measuring device when the inner ring is turned one revolution.
Outer ring axial runout (S_{ea})			For outer ring axial runout, record the difference between the maximum and minimum reading of the measuring device when the outer ring is turned one revolution.
Face runout with bore (S_d)			For face runout with bore, record the difference between the maximum and minimum reading of the measuring device when the inner ring is turned one revolution together with the tapered mandrel.
Variation of outside surface generatrix inclination with face for outer ring (S_b)			Variation of outside surface generatrix inclination with face for outer ring, record the difference between the maximum and minimum reading of the measuring device when the outer ring is turned one revolution along the reinforcement plate.

6. Load Rating and Life

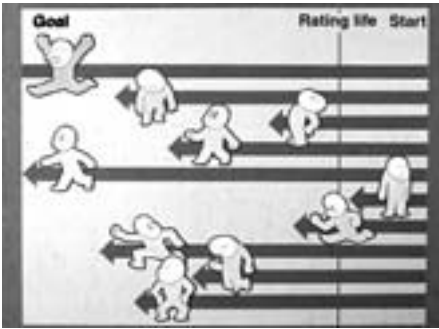

6.1 Bearing Life

One of the most important factors when selecting bearings is the life of the bearing. Bearing life depends on the functions required of a machine.

Fatigue life ... Life of the bearing in terms of material fatigue caused by rolling.

Lubrication life ... Life of the bearing in terms of burning caused by deterioration of lubricant.

Sound life ... Life of the bearing in terms of obstruction of bearing function caused by increase of turning sound.

Wear life ... Life of the bearing in terms of obstruction of bearing function caused by wear of the internal parts, single bore diameter and outside diameter of the bearing.

Precision life ... Life of the bearing in terms of becoming unusable due to deterioration of the turning precision required by the machine.

In the case of fatigue life, the material becomes fatigued due to repeated load stress between the raceway and rolling elements, resulting in flaking. Duration of life can be predicted by statistical calculation. Generally speaking, fatigue life is treated as bearing life.

6.2 Basic Rating Life and Basic Dynamic Load Rating

When individual bearings of a group of the same type of bearing are turned under the same conditions, basic rating life is defined as

the total number of times the bearing can be turned without flaking due to rolling fatigue in 90% (90% reliability) of the bearings.

Basic dynamic load rating expresses dynamic load capacity of rolling bearings, and therefore refers to a certain load, which provides basic rating life of one million revolutions. Basic dynamic load is expressed as pure radial load for radial bearings, and pure axial load for thrust bearings. Basic dynamic load rating C_r or C_a is given in the NTN catalog dimensions tables.

See page B-10 of the Ball and Roller Bearings catalog.

d 20~35mm

Boundary dimensions	Basic load ratings				Limit					
	dynamic	static	dynamic	static						
mm	KN	kgf	grease open type ZZ LLB	oil open type Z LLB						
d D B $r_{s, min}$ $r_{r, min}$	C_r	C_{or}	C_r	C_{or}						
20	72	19	1.1	—	28.5	13.9	2,900	1,420	12,000	14,000
22	44	12	0.6	0.5	9.40	5.05	955	515	17,000	20,000
	50	14	1	0.5	12.9	6.80	1,320	690	14,000	17,000

Basic rating life is calculated by equation 6.1 or 6.2.

$$L_{10} = \left(\frac{C}{P}\right)^p \dots\dots\dots (6.1)$$

$$L_{10h} = \frac{10^6}{60n} \left(\frac{C}{P}\right)^p \dots\dots\dots (6.2)$$

Where:

- L_{10} : Basic rating life (10^6 revolutions)
- L_{10h} : Basic rating life h (hours)
- C : Basic dynamic load rating N {kgf}
- C_r : Radial bearing
- C_a : Thrust bearing
- P : Dynamic equivalent load N {kgf}
- P_r : Radial bearing
- P_a : Thrust bearing
- n : Rotational speed rpm
- p : Ball bearing $p=3$
Roller bearing $p=10/3$

In equipment with several bearings, if the life of one develops rolling fatigue, it is considered to be the total life for all the bearings. Life can be calculated by equation 6.3.

$$L = \frac{1}{\left(\frac{1}{L_1} + \frac{1}{L_2} + \dots + \frac{1}{L_n}\right)^{1/e}} \dots\dots\dots(6.3)$$

Where:

- L : Total basic rating life as all bearings (h)
- $L_1, L_2 \dots L_n$: Basic rating life of individual bearings 1, 2... n (h)
- e : Ball bearing..... $e=10/9$
Roller bearing..... $e= 9/8$

In the case where load conditions vary at a fixed time percentage for a single bearing, life can be calculated by equation 6.4.

$$L_m = (\sum \phi_j / L_j)^{-1} \dots\dots\dots(6.4)$$

Where:

- L_m : Total life of bearing
- ϕ_j : Usage frequency of each condition ($\sum \phi_j = 1$)
- L_j : Life under each condition

Life can also be calculated as bearing life of the entire machine by equation 6.3. To put life in more simple terms, in the case of a ball bearing for example, when load (dynamic equivalent load) is doubled, it has the effect of a cube, so life is reduced by 1/8, as shown by equation 6.2. When rotational speed is doubled, life is halved.

6.3 Adjusted Rating Life

If much is known about how the machine is being used, bearing life can be more accurately estimated under a variety of conditions. In other words, adjusted rating life can be calculated by equation 6.5.

$$L_{na} = a_1 \cdot a_2 \cdot a_3 (C/P)^p \dots\dots\dots(6.5)$$

Where:

- L_{na} : Adjusted rating life (10^6 revolutions)
- a_1 : Life adjustment factor for reliability
- a_2 : Bearing characteristic coefficient
- a_3 : Usage condition coefficient

Life adjustment factor for reliability a_1

Bearing life is generally calculated at 90% reliability. In the case of bearings used in airplane engines, for example, reliability must however be above 90% if life directly affects the life of human beings. In this case, life is adjusted according to the values given in

Table 6.1.

Table 6.1 Life adjustment factor for reliability a_1

Reliability %	L_n	Life adjustment factor for reliability a_1
90	L_{10}	1.00
95	L_5	0.62
96	L_4	0.53
97	L_3	0.44
98	L_2	0.33
99	L_1	0.21

Bearing characteristic coefficient a_2

Bearing characteristics concerning life vary if special materials, quality or manufacturing processes are used for bearings. In this case life is adjusted by the bearing characteristic coefficient a_2 . Basic dynamic load rating given in the bearing dimensions table depends on the standard material and manufacturing method used by NTN, but $a_2 = 1$ is used under ordinary circumstances. $a_2 > 1$ is used for bearings made of special improved materials and manufacturing methods.

If bearings made of high carbon chrome are used at temperatures in excess of 120°C for an extended period of time, with ordinary heat treatment, dimension variation is large. Bearings having undergone dimension stabilizing treatment (**TS treatment**) are therefore used in this case. Life is sometimes affected by a decrease in hardness due to treatment temperature. (See **Table 6.2**)

Table 6.2 Dimension stabilizing treatment

Code	Max. operating temp. (°C)	Adjustment coefficient a_2
TS2	160	1.0
TS3	200	0.73
TS4	250	0.48

Life adjustment factor for operating condition a_3

Coefficient for adjusting life for lubrication conditions, rotational speed, running temperature, and other operating conditions. If lubrication conditions are favorable, a_3 is generally "1." If lubrication conditions are particularly good and other factors are normal, $a_3 > 1$ may be used.

Oppositely $a_3 < 1$ is used in the following cases:

- If lubrication oil viscosity is low (13 mm²/s or less for ball bearing; 20 mm²/s for roller bearing)
- Rotational speed is low (Rotational speed n by rolling element pitch circular d_p , $d_p \cdot n < 10,000$)
- If operating temperature is high (adjusted by **Fig. 6.1** due to decrease in hardness)

Items that consider coefficient a_2 by dimension stabilization treatment do not require adjustment of **Fig. 6.1** as long as each is used within maximum operating temperature.

Bearings are affected by various conditions other than these, but are not clarified as the a_3 coefficient. There is also the way of the a_{23} coefficient matching a_2 and a_3 , but at the present there is need to overlap the data.

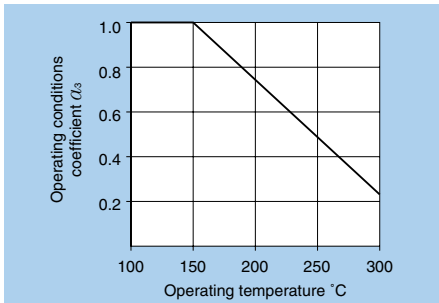

Fig. 6.1 Operating Conditions Coefficient According to Operating Temperature

In the case of an extremely large load, and there is danger of harmful plastic deformation developing on the contact surfaces of the rolling element and raceway, if P_r exceeds either C_{or} or $0.5 P_a$ in the case of radial bearings, or P_a exceeds $0.5 C_a$ in the case of thrust bearings, equations 6.1, 6.2 and 6.5 for calculating basic rating life cannot be applied.

6.4 Machine Applications and Requisite Life

When selecting bearings, you must select bearings that provide the life required for the machine. The general standards for life are given in **Table 6.3**.

6.5 Basic Static Load Rating

Bearing load where contact stress of maximum rolling element load is the following values is defined as basic static load rating.

Ball bearing	4 200MP	{428kgf/mm ² }
Roller bearing	4 000MPa	{408kgf/mm ² }

These values are the equivalent of the load where permanent set of approximately 0.0001 time the rolling element diameter is produced by the load in the area where the rolling elements make contact with the raceway surface. It is empirically known that the degree of deformation is as far as smooth rotation of the shaft is not impeded.

This basic static load rating is given in the dimension table as C_{or} and C_{oa} for radial and thrust bearings respectively.

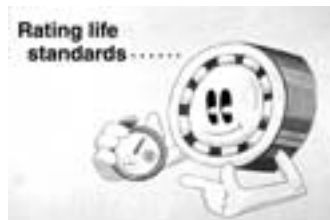

Table 6.3 Machine and Required Life (Reference)

Usage type	Machine and required life (reference) L_{10h}					$\times 10^3$ hours
	~4	4~12	12~30	30~60	60~	
Machine used occasionally or for limited periods of time	Household electrical appliances Power tools	Farming equipment Office equipment				
Machine used occasionally or for limited periods of time, but requires reliable operation	Medical equipment Measuring devices	Home air-conditioner Construction equipment Elevators Cranes	Cranes (sheave)			
Machine sometimes run for extended periods of time	Automobiles Motorcycles	Small motors Buses and trucks General gear-operated equipment Construction equipment	Machine tool spindles General purpose motors for factories Crushers Vibration screens	Important gear-operated equipment For use with rubber and plastic Calendar rollers Web presses		
Machines usually used more than 8 hours per day		Roller necks for rolling mills Escalators Conveyors Centrifuges	Passenger and freight vehicles (wheel) Air-conditioning equipment Large motors Compressor pumps	Locomotives (wheel) Traction motors Mining hoists Press flywheels	Pulp and papermaking equipment Ship propulsion units	
Machines that operate 24 hours a day, for which breakdown cannot be permitted					Water works Mine drainage/ventilation equipment Power plant equipment	

6.6 Allowable Static Equivalent Load

The quality of maximum static load for bearings is generally determined based on the value of the safety factor S_0 .

$$S_0 = \frac{C_0}{P_0} \dots\dots\dots(6.6)$$

Where:

- S_0 : Safety factor
- C_0 : Basic static load rating
(C_0 or C_{0a}) N {kgf}
- P_0 : Static equivalent load
(P_0 or P_{0a}) N {kgf}

For evaluation of S_0 , the amount of permanent set is based on the previous definition of C_{0r} and C_{0a} . It does not consider cracking of the rolling bearing ring or edge load of roller bearings. Evaluation must be empirically decided according to the machine and where it is used.

Table 6.4 Lower Limit Value of Safety Factor S_0

Operating conditions	Ball bearing	Roller bearing
If high rolling precision is required	2	3
If normal rolling precision is required (general purpose)	1	1.5

- Remarks 1. "4" is used for the lower limit value of S_0 for self-aligning thrust roller bearings.
 2. "3" is used for the lower limit value of S_0 for drawn cup needle roller bearings.
 3. P_0 is calculated taking shock load factor into consideration if there is vibration or shock load.
 4. If a large axial load is applied to deep groove ball bearings or angular contact ball bearings, the fact that contact ellipse may ride up on the raceway surface must be considered.

One-Point Advice

Bearing Tips

● Bearing with Higher Function and Longer Life

The life described in this handbook is basic rating life.

Bearings used for automobiles, steel equipment, machine tools, etc., must be designed to last a long time while providing the required function under limited conditions. NTN has the technologies required to do this. Some of them are given below.

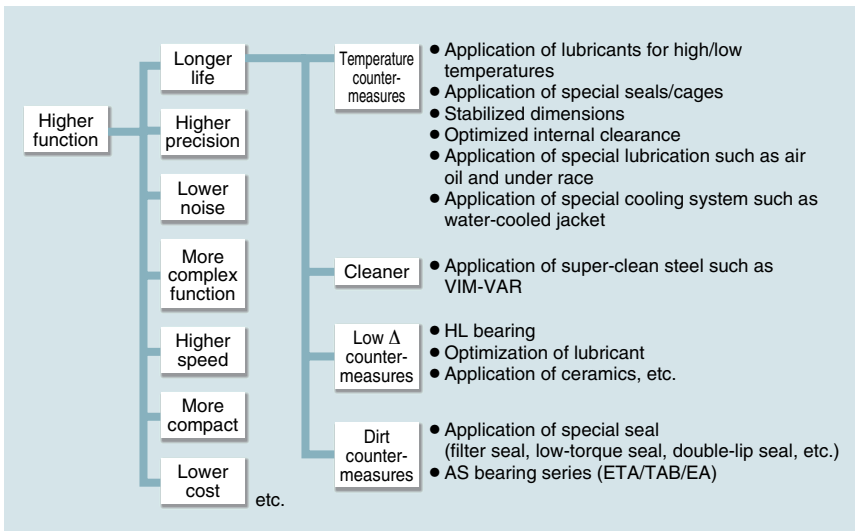

7. Bearing Load

In order to calculate bearing life and safety factor, you must first know what sort of load is applied to the bearing. In other words, there are various types of loads and directions such as the weight of the rolling elements and the object supported by the bearing, conductivity of the belt and gears and the load produced when the machine performs work. These must be arranged in radial and axial load directions and calculated as a combined radial and axial load.

7.1 Load Used for Shafting

(1) Load factor

Depending upon the machine, a large load is produced by vibration and shock from theoretical calculation values. Taking advantage of the load factor, it is sometimes treated as actual load.

$$K = f_w \cdot K_c \dots\dots\dots(7.1)$$

Where:

- K : Actual load placed on shaft N {kgf}
- f_w : Load factor (Table 7.1)
- K_c : Theoretical calculation value N {kgf}

Table 7.1 Load Factor f_w

Shock type	f_w	Machine
Almost no shock	1.0~1.2	Electric machinery, machine tools, measuring devices
Light shock	1.2~1.5	Railway cars, automobiles, rolling mills, metal machines, papermaking equipment, printing equipment, aircraft, textile machinery, electrical equipment, office equipment
Strong shock	1.5~3.0	Crushers, farming equipment, construction equipment, hoists

(2) Load on gears

When power is conveyed by gears, operating load differs according to the type of gear (spur, helical, bevel). As the simplest examples, spur and helical gears calculation is given here. Gear tangent load when shaft input torque is known:

$$K_t = \frac{2T}{D_p} \dots\dots\dots(7.2)$$

Where:

- K_t : Gear tangent load N {kgf}
- T : Input torque N · mm {kgf · mm}
- D_p : Gear pitch round mm

When transfer power as shaft input is known:

$$K_t = \frac{19.1 \times 10^6 \cdot H}{D_p \cdot n} \text{ N}$$

$$K_t = \frac{1.95 \times 10^6 \cdot H}{D_p \cdot n} \text{ {kgf}} \dots\dots\dots(7.3)$$

Where:

- n : Rotational speed rpm
- H : Transfer power kW
- $K_t = K_t \cdot \tan \alpha$ (Spur gear) $\dots\dots\dots(7.4)$
- $= K_t \cdot \frac{\tan \alpha}{\cos \beta}$ (Helical gear) $\dots\dots\dots(7.5)$
- $K_a = K_t \cdot \tan \beta$ (Helical gear) $\dots\dots\dots(7.6)$

Where:

- K_r : Radial load of gear
- K_a : Parallel load on gear shaft
- α : Pressure angle of gear
- β : Helix angle of gear

The following is calculated as a combined radial and axial load of radial load:

$$F_r = \sqrt{K_r^2 + K_a^2} \dots\dots\dots(7.7)$$

F_r : Right angle load on gear shaft

When actually calculating bearing load, however, axial load K_a also affects radial load. It is therefore easier to calculate combined radial and axial load last.

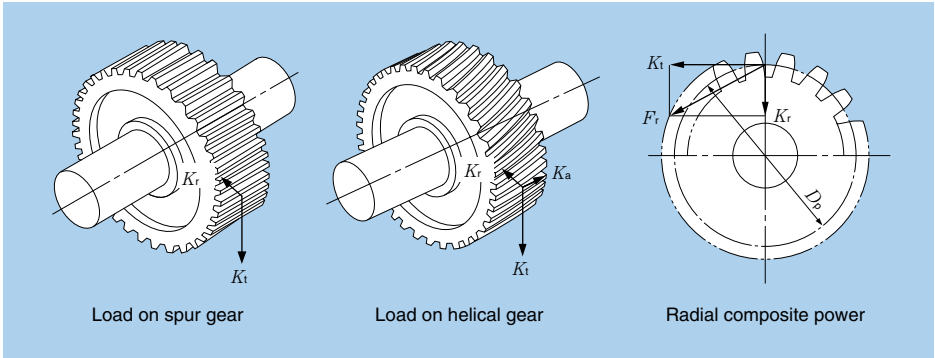

Fig. 7.1 Load on Gears

(3) Load on chain and belt shaft

The load on a sprocket or pulley when power is conveyed by a chain or belt is calculated as follows:

$$\begin{aligned}
 K_t &= \frac{19.1 \times 10^6 \cdot H}{D_p \cdot n} \text{ N} \\
 &= \frac{1.95 \times 10^6 \cdot H}{D_p \cdot n} \text{ \{kgf\}} \dots\dots\dots(7.8)
 \end{aligned}$$

Where:

- K_t : Load on sprocket or pulley N {kgf}
- H : Transfer power kW
- D_p : Pitch diameter of sprocket or pulley mm

To account for initial tension applied to the belt or chain, radial load is calculated by equation 7.9.

$$K_r = f_b \cdot K_t \dots\dots\dots(7.9)$$

Where:

- K_r : Radial load
- f_b : Chain/belt factor

Table 7.2 Chain/Belt Factor f_b

Type of chain/belt	f_b
Chain (single row)	1.2~1.5
V-belt	1.5~2.0
Timing belt	1.1~1.3
Flat belt (with tension pulley)	2.5~3.0
Flat belt	3.0~4.0

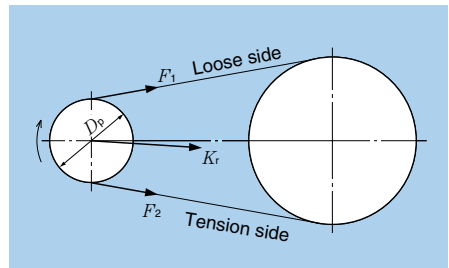

Fig. 7.2 Load on Chain/Belt

7.2 Bearing Load Distribution

Generally speaking, loads are placed on a shaft supported by bearings from various directions. The load is arranged as a radial or axial load depending on the size and direction of the load.

The following calculation procedure is modeled on the gears of the most common reduction gears. In **Fig. 7.3**, gear 1 is output (spur gear) and gear 2 is input (helical gear).

Where:

K_{t1}, K_{t2} : Gear tangential force
(perpendicular to space)

K_{r1}, K_{r2} : Gear separation force

K_a : Gear axial force

r_1, r_2 : Gear pitch circular radius

$$K_{t1} = \frac{r_2}{r_1} \cdot K_{t2}$$

The correlation of K_t and K_r/K_a is in accordance with equations 7.4, 7.5 and 7.6.

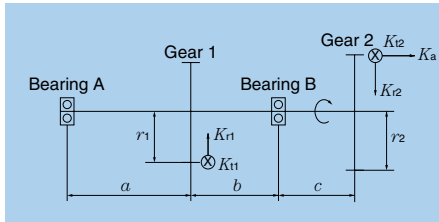

Fig. 7.3 Gear Load Transfer Example

(1) Load on bearing A

Load by K_{t1}/K_{t2}

$$F_{rAt} = \frac{b}{a+b} \cdot K_{t1} - \frac{c}{a+b} \cdot K_{t2}$$

Load by $K_{r1}/K_{r2}/K_a$

$$F_{rAr} = \frac{b}{a+b} \cdot K_{r1} + \frac{c}{a+b} \cdot K_{r2} + \frac{r_2}{a+b} \cdot K_a$$

Thus radial load on bearing A is:

$$F_{rA} = \sqrt{F_{rAt}^2 + F_{rAr}^2}$$

(2) Load on bearing B

(Axial load received by bearing B)

Load by K_{t1}/K_{t2}

$$F_{rBt} = \frac{a}{a+b} \cdot K_{t1} + \frac{a+b+c}{a+b} \cdot K_{t2}$$

Load by $K_{r1}/K_{r2}/K_a$

$$F_{rBr} = \frac{a}{a+b} \cdot K_{r1} - \frac{a+b+c}{a+b} \cdot K_{r2} - \frac{r_2}{a+b} \cdot K_a$$

Radial load on bearing B:

$$F_{rB} = \sqrt{F_{rBt}^2 + F_{rBr}^2}$$

Axial load on bearing B is K_a .

When one shaft is supported by three bearings, and there is a lot of distance between bearings, bearing load is calculated as 3-point support. A specific calculation example is extremely complicated, so the bearing load equation is given for a simple load example only. (See **Table 7.3**)

In actuality, various complicated loads are applied. We have therefore clearly indicated load direction and calculated these for each load individually. Finally we calculated bearing life as combined radial and axial load.

Table 7.3 Bearing Load of 3-Point Support Bearings

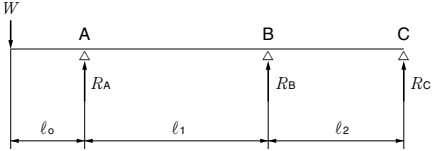
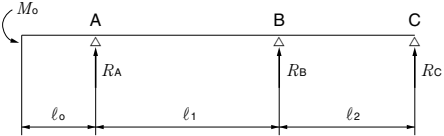
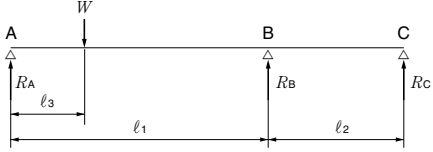
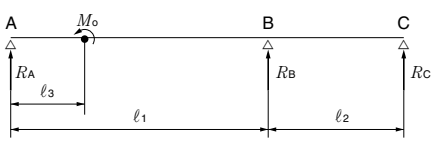
Load and moment direction	Bearing load
 <p>A horizontal beam is supported by three points: A, B, and C. A downward load W is applied at a distance l_0 from support A. The distance between supports A and B is l_1, and between B and C is l_2. Upward reaction forces are labeled R_A, R_B, and R_C.</p>	$R_B = -\frac{l_0(2l_2 + l_1)}{2l_1l_2}W$ $R_A = \frac{(l_1 + l_2 + l_0)W - l_2R_B}{l_1 + l_2}$ $R_C = -\frac{l_0W + l_1R_B}{l_1 + l_2}$
 <p>A horizontal beam is supported by three points: A, B, and C. A counter-clockwise moment M_0 is applied at support A. The distance between supports A and B is l_1, and between B and C is l_2. Upward reaction forces are labeled R_A, R_B, and R_C.</p>	$R_B = -\frac{(2l_2 + l_1)M_0}{2l_1l_2}$ $R_A = \frac{M_0 - l_2R_B}{l_1 + l_2}$ $R_C = -\frac{M_0 + l_1R_B}{l_1 + l_2}$
 <p>A horizontal beam is supported by three points: A, B, and C. A downward load W is applied at a distance l_3 from support A. The distance between supports A and B is l_1, and between B and C is l_2. Upward reaction forces are labeled R_A, R_B, and R_C.</p>	$R_B = \frac{l_3(l_1^2 + 2l_1l_2 - l_3^2)W}{2l_1^2l_2}$ $R_A = \frac{(l_1 + l_2 - l_3)W - l_2R_B}{l_1 + l_2}$ $R_C = \frac{l_3W - l_1R_B}{l_1 + l_2}$
 <p>A horizontal beam is supported by three points: A, B, and C. A clockwise moment M_0 is applied at support A. The distance between supports A and B is l_1, and between B and C is l_2. Upward reaction forces are labeled R_A, R_B, and R_C.</p>	$R_B = \frac{(-l_1^2 - 2l_1l_2 + 3l_3^2)M_0}{2l_1^2l_2}$ $R_A = \frac{M_0 - l_2R_B}{l_1 + l_2}$ $R_C = -\frac{M_0 + l_1R_B}{l_1 + l_2}$

7.3 Equivalent Load

7.3.1 Dynamic Equivalent Load

In many cases, both radial and axial loads are applied to bearings at the same time. In such a case, this is converted to pure radial load for radial bearings, and pure axial load for thrust bearings. A hypothetical load which provides an equal life is called a "dynamic equivalent load."

(1) Dynamic equivalent radial load

Dynamic equivalent radial load is calculated by equation 7.10.

$$P_r = XF_r + YF_a \quad \dots\dots\dots(7.10)$$

Where:

- P_r : Dynamic equivalent radial load N {kgf}
- F_r : Radial load N {kgf}
- F_a : Axial load N {kgf}
- X : Radial load factor
- Y : Axial load factor

The values of XY are given in the dimensions table of the catalog.

(2) If bearing has a contact angle

A bearing having a contact angle such as angular contact ball bearings and tapered roller bearings have their pressure cone apex at a position off center of the bearing. When a radial load is placed on the bearing, a component force is produced in the axial direction. This force is generally referred to as

"induced thrust," and its magnitude is calculated by equation 7.11.

$$F_a = \frac{0.5F_r}{Y} \quad \dots\dots\dots(7.11)$$

Where:

- F_a : Axial direction component force (induced thrust) N {kgf}
- F_r : Radial load N {kgf}
- Y : Axial load factor

These bearings are generally used in symmetrical arrangement. A sample calculation is given in **Table 7.4**.

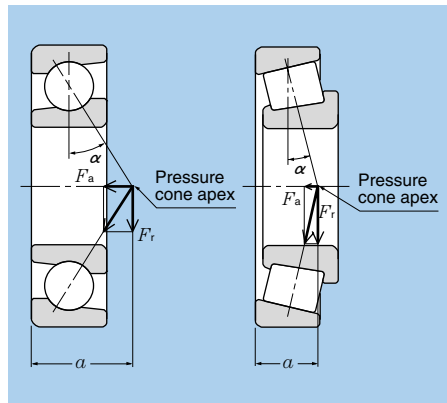

Fig. 7.4 Bearing Pressure Cone Apex and Axial Direction Component Force

Table 7.4 Sample Calculation of Axial Component Force

Bearing arrangement	Load conditions	Axial load	Dynamic equivalent radial load
	$\frac{0.5F_{rI}}{Y_I} \leq \frac{0.5F_{rII}}{Y_{II}} + F_a$	$F_{aI} = \frac{0.5F_{rII}}{Y_{II}} + F_a$ $F_{aII} = \frac{0.5F_{rII}}{Y_{II}}$	$P_{rI} = XF_{rI} + Y_I \left(\frac{0.5F_{rII}}{Y_{II}} + F_a \right)$ $P_{rII} = F_{rII}$
	$\frac{0.5F_{rI}}{Y_I} > \frac{0.5F_{rII}}{Y_{II}} + F_a$	$F_{aI} = \frac{0.5F_{rI}}{Y_I}$ $F_{aII} = \frac{0.5F_{rI}}{Y_I} - F_a$	$P_{rI} = F_{rI}$ $P_{rII} = XF_{rII} + Y_{II} \left(\frac{0.5F_{rI}}{Y_I} - F_a \right)$

Remarks 1. F_{rI} and F_{rII} are applied to bearings I and II respectively, as well as axial load F_a .
 2. Applies when preload is 0.

7.3.2 Static Equivalent Load

Static equivalent load refers to pure radial or axial load that provides the same amount of permanent set as the maximum permanent set produced in the contact surface of the rolling elements and raceway when receiving the maximum load under actual load conditions.

This is used for bearing selection under load conditions where the bearing is stationary or turns at extremely low speed.

(1) Static equivalent radial load

The larger one of the values calculated by equations 7.12 and 7.13 is used for static equivalent radial load of radial bearings.

$$P_{or} = X_o F_r + Y_o F_a \dots\dots\dots(7.12)$$

$$P_{or} = F_r \dots\dots\dots(7.12)$$

Where:

- P_{or} : Static equivalent radial load N {kgf}
- F_r : Radial load N {kgf}
- F_a : Axial load N {kgf}
- X_o : Static radial load factor
- Y_o : Static axial load factor

The values of X_o and Y_o are given in the dimensions table of the catalog.

When $P_{or} < F_r$ use $P_{or} = F_r$
For values of e , Y_2 and Y_0 see the table below.

See page B-135 of the Ball and Roller Bearings catalog.

S_b	r_{1a} min	r_{1a} max	r_{1a} max	Load center mm	Constant e	Axial load factors		Mass kg (approx.)
						Y_2	Y_0	
3	1	1	1	9.5	0.29	2.11	1.16	0.098
2	1	1	1	9.5	0.35	1.74	0.96	0.08
3	1	1	1	11.5	0.31	1.92	1.06	0.102
3	1	1	1	11	0.35	1.74	0.96	0.104

7.4 Allowable Axial Load

A radial bearing can also receive an axial load, but there are various limits according to the type of bearing.

(1) Ball bearings

When an axial load is applied to ball bearings such as deep groove ball bearings and angular contact ball bearings, contact angle changes along with load. When the permissible range is exceeded, contact ellipse of the balls and raceway surface protrudes from the groove.

As shown in **Fig. 7.5**, the contact surface is elliptical with a major axis radius of a . The critical load where the contact ellipse doesn't go over the edge of the groove is the maximum allowable axial load (even if the contact ellipse doesn't go over the edge of the groove, allowable axial load must be $P_{max} < 4$ 200 MPa). This load differs for the bearing internal clearance, groove curvature, groove edge, etc. If it is also carrying a radial load, critical load is checked by maximum rolling element load.

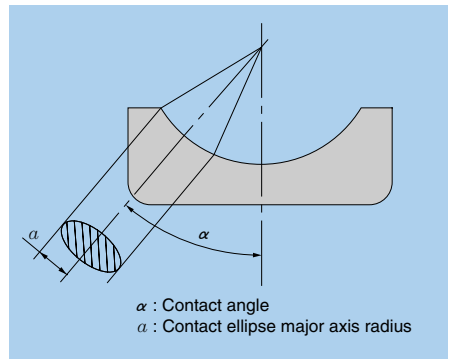

Fig. 7.5 Contact Ellipse

(2) Tapered roller bearings

Tapered roller bearings receive an axial load at both the raceway surface and where the roller end faces come in contact with the cone back face rib. Thus, by increasing contact angle α , the bearing becomes capable of receiving a large axial load. Because the roller end faces slide along the surface of the cone back face rib, this is limited according to rotational speed and lubrication conditions. This is generally checked by the value of PV , which takes advantage of sliding speed of surface pressure of the sliding surface.

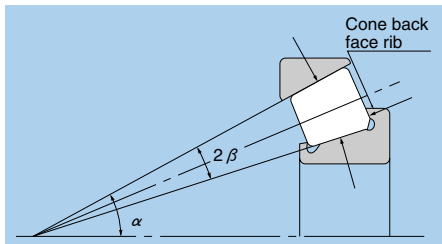

Fig. 7.6 Tapered Roller Bearing

(3) Allowable axial load for cylindrical roller bearings

Cylindrical roller bearings with inner and outer rings having ribs are capable of simultaneously receiving a radial load and a certain amount of axial load. In this case, allowable axial load is decided by heat and wear of the sliding surface between the roller end faces and rib.

Based on experience and testing, allowable load in the case where a centric axial load is to be supported can be approximated by equation 7.14.

$$P_t = k \cdot d \cdot P_z \dots \dots \dots (7.14)$$

Where:

- P_t : Allowable axial load when turning N {kgf}
- k : Factor decided according to bearing internal design (see **Table 7.5**)
- d : Bearing bore mm
- P_z : Allowable surface pressure of rib MPa {kgf/mm²} (see **Fig. 7.7**)

If axial load is however larger than radial load, normal rolling of the rollers is negatively affected, so be careful not to allow $F_a \text{ max}$ to be exceeded. Lubrication conditions, mounting dimensions and precision must also be taken into consideration.

Table 7.5 Value of Factor k and Allowable Axial Load ($F_a \text{ max}$)

Bearing series	K	$F_a \text{ max}$
NJ, NUP10 NJ, NUP, NF, NH2, NJ, NUP, NH22	0.040	$0.4F_r$
NJ, NUP, NF, NH3, NJ, NUP, NH23	0.065	$0.4F_r$
NJ, NUP, NH2E, NJ, NUP, NH22E	0.050	$0.4F_r$
NJ, NUP, NH3E, NJ, NUP, NH23E	0.080	$0.4F_r$
NJ, NUP, NH4,	0.100	$0.4F_r$
SL01-48	0.022	$0.2F_r$
SL01-49	0.034	$0.2F_r$
SL04-50	0.044	$0.2F_r$

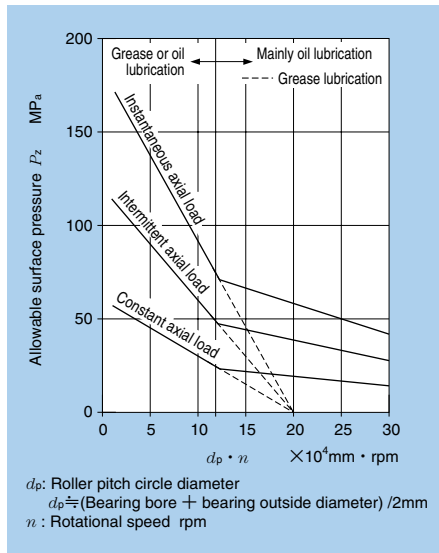

Fig. 7.7 Allowable Surface Pressure of Rib

8. Fits

8.1 Bearing Fits

The inner and outer rings of bearings support a load that rotates, and are therefore mounted on the shaft and housing. In this case, fitting of the inner ring with the shaft, and outer ring with the housing differs according to nature of the load, assembly of the bearing and ambient environment, depending upon whether the fit is provided with clearance or interference. The three basic types of fitting are as follows:

(1) Clearance fit

Mounted with clearance in the fit.

(2) Transition fit

Mounted with both clearance and interference in the fit.

(3) Interference fit

Mounted in if fixed position with interference in the fit.

The most effective method of mounting a bearing to support a load is to provide interference by fastening with an interference fit. There are also advantages in providing clearance, such as mounting, dismounting and absorption of expansion and contraction

of the shaft and housing due to change in temperature. If you do not provide interference that matches the load, creep may be produced by rotation. As shown in **Fig. 8.1**, if there is creep in the clearance difference of the fit that turns while receiving the load, slipping may be produced by the difference in the inner ring bore and circumference length, resulting in abnormal heat, abrasion and powder which negatively affect the bearing. Even if there is no clearance, creep may occur if the load is large. You should therefore decide the proper fit using **Table 8.2** as a guideline.

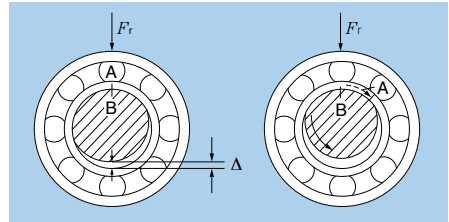

Fig. 8.1 Bearing Creep

Table 8.1 Nature and Fit of Radial Loads

Diagram	Rotation division	Nature of load	Fit
<p>Static load</p>	<p>Inner ring: rotating Outer ring: stationary</p>	Inner ring turning load	Inner ring: Interference fit
<p>Unbalanced load</p>	<p>Inner ring: stationary Outer ring: rotating</p>	Outer ring static load	Outer ring: Clearance fit
<p>Static load</p>	<p>Inner ring: stationary Outer ring: rotating</p>	Inner ring static load	Inner ring: Clearance fit
<p>Unbalanced load</p>	<p>Inner ring: rotating Outer ring: stationary</p>	Outer ring turning load	Outer ring: Interference fit

Interference or clearance range on the other hand is decided by dimension tolerance of the bearing, shaft and housing. Fit therefore requires sufficient consideration.

8.2 Fit Selection

Proper fit selection is dependent upon thorough analysis of bearing operating conditions:

- Shaft and housing material, wall thickness, rigidity and finished surface precision
- Machinery operating conditions (nature and magnitude of load, rotating speed, temperature, etc.)

The basic philosophy for fit concerns whether it is the inner or outer ring that turns. Fit is decided by which of the bearing rings the load moves along, and is as given in **Table 8.1**.

The relationship of dimension tolerance for the housing and shaft on which the bearing is to be mounted is as shown in **Fig. 8.2**.

Some of the general fitting criteria for various types of bearings under various operating conditions is given in **Figs. 8.2** through **8.4**. For details, see "A45 - 53 of the NTN Ball and Roller Bearings catalog".

Table 8.2 Tolerance Class of Shaft Used for Radial Bearings (Class 0, 6X, 6)

Conditions	Ball bearings		Cylindrical roller bearings Tapered roller bearings		Self-aligning roller bearings		Shaft tolerance class	Remarks	
	Shaft diameter (mm)								
	Over	Up to	Over	Up to	Over	Up to			
Cylindrical bore bearing (Class 0, 6X, 6)									
Inner ring rotating load or indeterminate direction load	Light or fluctuating load ①	—	18	—	—	—	—	h5 js6 k6 m6	js5, k5 and m5 may be used in place of js6, k6 and m6 if more precision is required.
		18	100	—	40	—	—		
		100	200	40	140	—	—		
	Normal load ①	—	18	—	—	—	—	js5 k5 m5 m6 n6 p6 r6	Internal clearance variation according to fit doesn't have to be considered for single row angular contact ball bearings and tapered roller bearings. You may therefore use k6 and m6 in place of k5 and m5.
		18	100	—	40	—	40		
		100	140	40	100	40	65		
		140	200	100	140	65	100		
		200	280	140	200	100	140		
		—	—	200	400	140	280		
Heavy or shock load ①	—	—	50	140	50	100	n6 p6 r6	Use bearing with internal clearance larger than CN clearance bearing.	
	—	—	140	200	100	140			
	—	—	200	—	140	200			
Inner ring static load	Inner ring must be able to move easily on shaft.	All shaft diameters						g6	Use g5 if more precision is required. F6 is also OK to facilitate movement in the case of large bearings.
	Inner ring does not have to be able to move easily on shaft.	All shaft diameters						h6	Use h5 if more precision is required.
Centric axial load	All shaft diameters						js6	Shaft and bearing are not generally fixed by fit.	
Tapered bore bearing (class 0) (W/ adapter or withdrawal sleeve)									
All loads	All shaft diameters						h9/IT5 ②	H10/IT7 may also be used with conductive shaft ②	

① Light, normal and heavy load refer to basic dynamic radial load rating of 6% or less, above 6% to 12% and less, and over 12% for dynamic equivalent radial load.

② Shaft circular and cylindrical tolerance values are given for IT5 and IT7.

Remarks: This table applies to steel solid shafts.

Table 8.3 Tolerance Class of Housing Bore Used for Radial Bearings (Class 0, 6X, 6)

Housing		Conditions		Tolerance class of housing bore	Remarks	
		Load type, etc.	Transfer in axial direction of outer ring ③			
Integral or two-piece housing	Outer ring static load	All load types	Able to transfer.	H7	G7 may be used for large bearings or when there is a large temperature difference between outer ring and housing.	
		① Light or normal loads ①	Able to transfer.	H8	—	
		Temperature of shaft and inner ring become high.	Easily able to transfer.	G7	F7 may be used for large bearings or when there is a large temperature difference between outer ring and housing.	
Integral housing	Indeterminate direction load	Requires precision rotation with light or normal loads.	As a rule, not able to transfer.	K6	Primarily applies to roller bearings.	
			Able to transfer.	JS6	Primarily applies to ball bearings.	
		Requires silent running.	Able to transfer.	H6	—	
	Outer ring rotating load	Light or normal loads	Able to transfer.	JS7	JS6 and K6 may be used in place of JS7 and K7 if more precision is required.	
			Normal or heavy loads ①	As a rule, not able to transfer.	K7	—
			Large shock loads	Not able to transfer	M7	—
	Outer ring rotating load	Light or fluctuating loads	Not able to transfer	M7	—	
			Normal or heavy loads	Not able to transfer	N7	Primarily applies to ball bearings.
			Heavy or large shock loads with thin wall housing	Not able to transfer	P7	Primarily applies to roller bearings.

① In accordance with ① of Table 8.2.

③ Data for non-separable bearings is given separately according to whether or not the outer ring is capable of transfer in the axial direction.

Remarks 1. This table applies to cast iron or steel housing.

2. If only centric axial load is applied to the bearing, select a tolerance class that provides the outer ring with clearance in the radial direction.

Table 8.4 Tolerance Class of Shaft Used for Thrust Bearings (Class 0, 6X, 6)

Conditions	Shaft diameter (mm)		Shaft tolerance class	Remarks	
	Over	Up to			
Centric axial load (thrust bearings in general)	All shaft diameters		js6	Also used for h6.	
Combined radial and axial load (self-aligning thrust roller bearing)	Inner ring static load		js6	—	
	Inner ring rotating or indeterminate direction load	—	200	k6	js 6, k6 and m6 may be used in place of k6, m6 and n6 respectively.
		200	400	m6	
400	—	n6			

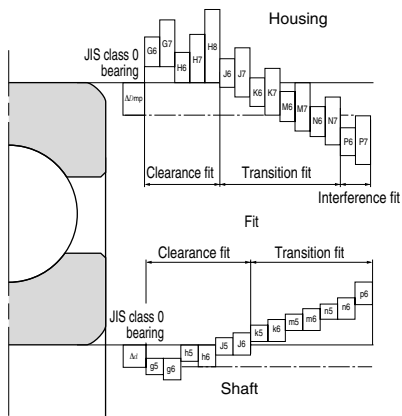

Fig. 8.2 Bearing Fit Status

8.3 Fit Calculation

As was previously stated, standards for bearing fits have already been set, but problems such as creep, bearing ring cracking and premature flaking may occur depending on conditions such as actual assembly, load and temperature. The following items must be checked if interference is necessary.

(1) Load and interference

When a radial load is placed on a bearing, interference between the inner ring and shaft is reduced. Thus, interference varies according to the size of the load. The required interference is calculated by the following equation. (The equation supposes that a solid steel shaft is used.)

$$\left. \begin{aligned} \text{When } F_r \leq 0.3 C_{or} \\ \Delta d_F = 0.08 (d \cdot F_r / B) / 2 \text{ N} \\ = 0.25 (d \cdot F_r / B) / 2 \text{ \{kgf\}} \end{aligned} \right\} \dots (8.1)$$

$$\left. \begin{aligned} \text{When } F_r > 0.3 C_{or} \\ \Delta d_F = 0.02 (F_r / B) \text{ N} \\ = 0.2 (F_r / B) \text{ \{kgf\}} \end{aligned} \right\} \dots (8.2)$$

Where

- Δd_F : Required effective interference according to radial load (μm)
- d : Bearing bore (mm)
- B : Inner ring width (mm)
- F_r : Radial load N \{kgf\}
- C_{or} : Basic static load rating N \{kgf\}

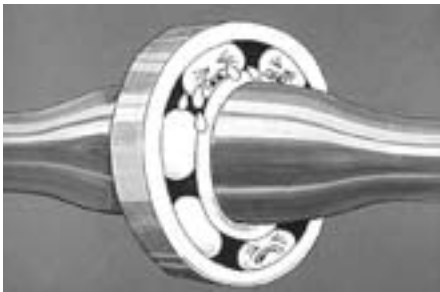

(2) Temperature and interference

The temperature of the shaft and housing generally rises while the bearing is operating. As a result, interference between the inner ring and shaft is reduced. In this case, interference is calculated by the following equation.

$$\Delta d_T = 0.0015 \cdot d \cdot \Delta T \quad (8.3)$$

Where:

- Δd_T : Required effective interference according to temperature difference (μm)
- ΔT : Difference between bearing temperature and ambient temperature ($^{\circ}\text{C}$)
- d : Bearing bore (mm)

(3) Interference and surface roughness of fit surface

Fit surface roughness of the shaft and housing is crushed to a certain extent, reducing interference by that amount. The amount that interference is reduced differs according to roughness of the fit surface, but this is generally compensated somewhat when calculating inner ring expansion and outer ring contraction factors.

(4) Maximum interference

Tensile stress is produced in the bearing ring mounted on the shaft when interference is provided. If excessive interference is applied, the bearing ring could be cracked or life reduced. The upper limit value for interference is generally 1/1000 of the shaft diameter or less.

In the case of heavy or shock loads, calculate fit stress with detailed analysis. It is generally safe as long as 13 kgf/mm^2 is not exceeded for bearing steel, or 18 kgf/mm^2 for carburizing steel.

8.4 Pressure of Fit Surface

The pressure that is produced on the fit surface and equation for calculating maximum stress are given in **Table 8.5**.

Mean groove diameter for the inner and outer rings of the bearing can be approximated from **Table 8.6**.

Interference that effectively works on fit surface pressure, i.e. "effective interference

$\Delta_{d\text{eff}}$, is smaller than interference Δd (theoretical interference) calculated from dimension measurements of the shaft or bearing bore. This is primarily due to the influence of finish surface roughness. The following reduction amounts must therefore be anticipated.

Grinding shaft : 1.0 ~ 2.5 μm
 Turning shaft : 5.0 ~ 7.0 μm

Table 8.5 Pressure and Maximum Stress of Fit Surface

Fit conditions		Equation	Symbols (Unit: N {kgf} , mm)
Fit surface pressure MPa {kgf / mm ² }	Fit of hollow steel shaft and inner ring	$P = \frac{E}{2} \frac{\Delta_{d\text{eff}}}{d} \left[1 - \left(\frac{d}{D_i} \right)^2 \right]$	d : Shaft diameter, inner ring bore d_o : Hollow shaft bore D_i : Inner ring mean groove diameter E : Elastic factor = 208 000 MPa { 21 200 kgf/mm ² }
	Fit of hollow steel shaft and outer ring	$P = \frac{E}{2} \frac{\Delta_{d\text{eff}}}{d} \frac{[1 - (d/D)^2] [1 - (d_o/D_h)^2]}{[1 - (d_o/D_h)^2]}$	$\Delta_{d\text{eff}}$: Effective interference D : Housing bore, bearing outside diameter D_o : Outer ring mean groove diameter D_h : Housing outside diameter $\Delta_{D\text{eff}}$: Effective interference
	Fit of steel housing and outer ring	$P = \frac{E}{2} \frac{\Delta_{D\text{eff}}}{D} \frac{[1 - (D_o/D)^2] [1 - (D/D_h)^2]}{[1 - (D_o/D_h)^2]}$	
Max. stress MPa {kgf / mm ² }	Fit of shaft and inner ring	$\sigma_{t \text{ max}} = P \frac{1 + (d/D_h)^2}{1 - (d/D_h)^2}$	Tangent stress of inner ring bore is maximum.
	Fit of housing and outer ring	$\sigma_{t \text{ max}} = P \frac{2}{1 - (D_o/D)^2}$	Tangent stress of outer ring bore is maximum.

Table 8.6 Mean Groove Diameter

Bearing type		Mean groove diameter	
		Inner ring (D_i)	Outer ring (D_o)
Deep groove ball bearing	All types	$1.05 \frac{4d + D}{5}$	$0.95 \frac{d + 4D}{5}$
Cylindrical roller bearing ❶	All types	$1.05 \frac{3d + D}{4}$	$0.98 \frac{d + 3D}{4}$
Self-aligning roller bearing	All types	$\frac{2d + D}{3}$	$0.97 \frac{d + 4D}{5}$

d : Inner ring bore mm D : Outer ring outside diameter mm

❶ Values given for mean groove diameter are those for double ribs.

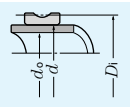
8.5 Force Required for Press Fit and Drawing

The force required to pressure fit the inner ring on the shaft and the outer ring on the housing, or for drawing the inner ring off the shaft or outer ring off the housing is calculated by equations 8.4 and 8.5.

For shaft and inner ring:

$$K_d = \mu \cdot P \cdot \pi \cdot d \cdot B \dots\dots\dots(8.4)$$

For housing and outer ring:

$$K_D = \mu \cdot P \cdot \pi \cdot D \cdot B \dots\dots\dots(8.5)$$

Where:

- K_d : Inner ring pressure fit or drawing force
N {kgf}
- K_D : Outer ring pressure fit or drawing force
N {kgf}
- P : Fit surface pressure MPa {kgf/mm²}
(See **Table 8.5**)
- d : Shaft diameter, inner ring bore (mm)
- D : Housing bore, outer ring outside diameter (mm)
- B : Inner or outer ring width
- μ : Sliding friction coefficient
(See **Table 8.7**)

Table 8.7 Sliding Friction Coefficient for Pressure Fit and Draw

Item	μ
When pressure fitting inner (outer) ring on cylindrical shaft (hollow)	0.12
When drawing inner (outer) ring off cylindrical shaft (hollow)	0.18
When pressure fitting inner ring on tapered shaft or sleeve	0.17
When drawing inner ring off tapered shaft	0.14
When pressure fitting sleeve on shaft or bearing	0.30
When drawing sleeve off shaft or bearing	0.33

9. Bearing Internal Clearance and Preload

9.1 Bearing Internal Clearance

As shown in Fig. 9.1, prior to mounting the bearing on the shaft and housing, when either the inner or outer ring is in a fixed position the amount of transfer when the counterpart is moved in the radial or axial direction is called

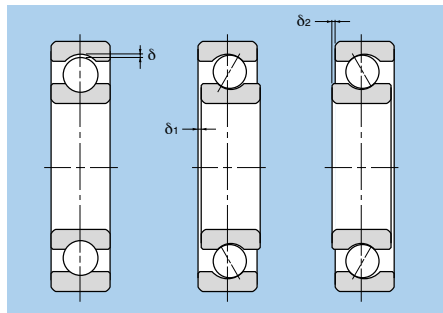

Radial internal clearance = δ

Axial internal clearance = $\delta_1 + \delta_2$

Fig. 9.1 Bearing Internal Clearance

radial internal clearance or axial internal clearance. This internal clearance is standardized by ISO 5753 (JIS B 1520). Radial internal clearance for deep groove ball bearings is given as an example in Table 9.1. For details, see "A54 - 65 of the "NTN Ball and Roller Bearings catalog".

Measurement load is of course applied when measuring clearance. Measurement load and correction values have been established as shown in Table 9.2 due to elastic deformation caused by measurement load, particularly for ball bearings.

Table 9.2 Radial Internal Clearance Correction Values for Measurement Load (Deep Groove Ball Bearing) Unit: μm

Nominal bearing bore diameter d mm	Measurement load N [kgf]	Internal clearance correction amount						
		C2	CN	C3	C4	C5		
10 ^①	18	24.5	{2.5}	3~4	4	4	4	4
18	50	49	{5}	4~5	5	6	6	6
50	200	147	{15}	6~8	8	9	9	9

① This diameter is included in the group.

Table 9.1 Radial Internal Clearance for Deep Groove Ball Bearings

Unit: μm

Nominal bearing bore diameter d mm	Over	C2		CN		C3		C4		C5	
		Min.	Max.	Min.	Max.	Min.	Max.	Min.	Max.	Min.	Max.
—	2.5	0	6	4	11	10	20	—	—	—	—
2.5	6	0	7	2	13	8	23	—	—	—	—
6	10	0	7	2	13	8	23	14	29	20	37
10	18	0	9	3	18	11	25	18	33	25	45
18	24	0	10	5	20	13	28	20	36	28	48
24	30	1	11	5	20	13	28	23	41	30	53
30	40	1	11	6	20	15	33	28	46	40	64
40	50	1	11	6	23	18	36	30	51	45	73
50	65	1	15	8	28	23	43	38	61	55	90
65	80	1	15	10	30	25	51	46	71	65	105
80	100	1	18	12	36	30	58	53	84	75	120
100	120	2	20	15	41	36	66	61	97	90	140
120	140	2	23	18	48	41	81	71	114	105	160
140	160	2	23	18	53	46	91	81	130	120	180
160	180	2	25	20	61	53	102	91	147	135	200
180	200	2	30	25	71	63	117	107	163	150	230
200	225	2	35	25	85	75	140	125	195	175	265
225	250	2	40	30	95	85	160	145	225	205	300
250	280	2	45	35	105	90	170	155	245	225	340
280	315	2	55	40	115	100	190	175	270	245	370
315	355	3	60	45	125	110	210	195	300	275	410
355	400	3	70	55	145	130	240	225	340	315	460
400	450	3	80	60	170	150	270	250	380	350	510
450	500	3	90	70	190	170	300	280	420	390	570
500	560	10	100	80	210	190	330	310	470	440	630
560	630	10	110	90	230	210	360	340	520	490	690

9.2 Internal Clearance Selection

During operation, clearance largely affects bearing performance such as bearing life, heat, vibration and sound. It is therefore necessary to select the clearance that matches operating conditions. If the clearance is theoretically slightly negative, optimal bearing life values are given, but if the clearance is further to the negative side, life decreases radically. Operating conditions are likely to fluctuate during operation due to a variety of factors. Generally speaking, you should therefore select initial bearing internal clearance so that operating clearance is slightly larger than 0.

Internal clearance during operation is calculated by the following equation:

$$\delta_{\text{eff}} = \delta_o - (\delta_f + \delta_t) \dots\dots\dots(9.1)$$

Where:

- δ_{eff} : Operating clearance (mm)
- δ_o : Bearing initial internal clearance (mm)
- δ_f : Internal clearance reduction due to interference (mm)
- δ_t : Internal clearance reduction due to the difference in temperature of the inner and outer rings (mm)

(1) Internal clearance reduction due to interference

If the inner and outer rings are mounted on the shaft or housing with interference, the inner

ring expands, the outer ring contracts, and internal clearance decreases by that amount.

The amount of reduction differs according to the type of bearing, shape of shaft or housing, dimensions and material, but it is approximately 70 - 90% of effective interference.

$$\delta_f = (0.70 \sim 0.90) \Delta_{\text{eff}} \dots\dots\dots(9.2)$$

δ_f : Internal clearance reduction due to interference (mm)

Δ_{eff} : Effective interference (mm)

To calculate more precisely, you can take material, shape and dimensional shape of each part into consideration. Dimension tolerance is supposed to be normal distribution, and is generally calculated by 3σ .

(2) Internal clearance reduction due to the difference in temperature of the inner and outer rings

As for bearing temperature during operation, temperature of the outer ring is generally 5 - 10°C lower than that of the inner ring or rolling elements. When heat radiation of the housing and shaft are connected to the heat source, temperature difference further increases. Internal clearance decreases by precisely the amount of the inner and outer rings expand due to the difference in temperature.

$$\delta_t = \alpha \cdot \Delta T \cdot D_o \dots\dots\dots(9.3)$$

δ_t : Internal clearance reduction due to the difference in temperature of the inner and outer rings

α : Coefficient of linear expansion for bearing materials $12.5 \times 10^{-6}/^\circ\text{C}$

ΔT : Difference in temperature of the inner and outer rings ($^\circ\text{C}$)

D_o : Raceway diameter of the outer ring (mm)

Raceway diameter of outer ring is

approximated by the following equation.

For ball bearings and self-aligning roller bearings

$$D_o = 0.2 (d + 4D) \dots\dots\dots(9.4)$$

For ball bearings and self-aligning roller bearings

$$D_o = 0.25 (d + 3D) \dots\dots\dots(9.5)$$

d : Bearing bore diameter

D : Bearing outside diameter

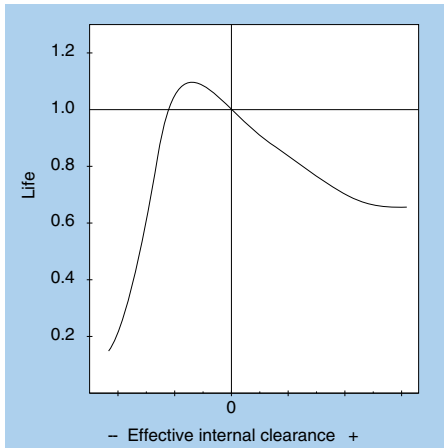

Fig. 9.2 Internal Clearance and Life

9.3 Preload

Bearings are used with minimal clearance during operation. Bearings used in pairs such as angular contact ball bearings and tapered roller bearings are sometimes used with negative clearance in the axial direction, depending upon the application. This condition is called "preload." This means there is elastic contact between the rolling elements and raceway surface.

The following effects are obtained as a result:

- Bearing rigidity increases.
- Suitable for high-speed rotation.
- Rotation precision and positioning precision is enhanced.
- Vibration and noise are suppressed.
- Smearing which can cause the rolling element to slip is reduced.
- Fretting produced by external vibration is prevented.

Excessive preload however invites life reduction, abnormal heating, and increase of rotating torque.

(1) Preload method

There are two ways to provide preload: one is fixed position preload where the opposing bearing is fastened in a fixed position and a certain preload is applied by adjusting bearing width dimensions, spacer and shim dimensions, and the other is fixed pressure preload where preload is applied by a spring.

Concrete examples of the preload methods are given in **Table 9.3**.

Standard preload amounts are set for duplex angular contact ball bearings. (See NTN catalog) 

● Bearing Internal Clearance and Preload							
See page A-64 of the Ball and Roller Bearings catalog.							
Table 8.13 The normal preload of duplex arrangement angular contact ball bearings							
Nominal bore diameter <i>d</i> (mm)	7BC				7BC, HS89C		
	Low	Normal	Central	Heavy	Low	Normal	Central
over inch							
12	-	-	-	-	-	-	-
12	18	-	-	-	-	-	-
18	32	10 1	29 3	78 8	147 15	20 2	49 5 98 10
32	40	10 1	29 3	78 8	147 15	29 3	78 8 196 20
40	50	20 2	49 5	98 10	196 20	39 4	98 10 245 25
50	65	29 3	98 10	196 20	390 40	49 5	118 12 294 30

Table 9.3 Preload Method and Characteristics

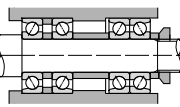
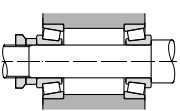
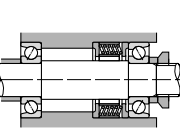
Preload method	Preload basic pattern	Applicable bearings	Objective of preload	Method and preload amount	Usage example
Fixed position preload		Angular contact ball bearings	Maintain shaft precision, prevent vibration, enhance rigidity	Certain amount of preload is provided by planar difference of inner/outer ring width or spacer.	Grinders Turning machines Milling machines Measuring devices
		Tapered roller bearings Thrust ball bearings Angular contact ball bearings	Enhance rigidity of bearing.	Preload is provided by loosening screws. Amount of preload is set with measuring starting torque of bearing or transfer distance of bearing rings.	Turning machines Milling machines Automobiles Differential pinions Printing presses Wheels
Fixed pressure preload		Angular contact ball bearings Deep groove ball bearings Tapered roller bearings (high speed)	Maintain precision and prevent vibration/noise without changing preload by load, temperature, etc.	Preload is provided by coil springs, disc springs, etc. Deep groove ball bearings 4~10 <i>d</i> N 0.4~1.0 <i>d</i> {kgf} <i>d</i> : Shaft diameter (mm)	Internal cylindrical grinding machines Electric motors Small high-speed shafts Tension reels

(2) Preload and rigidity

When an axial load is placed on a bearing, in many cases rigidity is enhanced and preload is applied to reduce displacement of the bearing in the axial direction. Let's therefore consider the correlation of load and displacement when outside pressure is placed on a bearing to which preload is applied.

Displacement of various bearings by elastic deformation is shown in Fig. 9.3.

As shown in the figure, when the inner ring tightly adheres in the axial direction, preload

load F_o is applied, producing δ_o elastic deformation. When external force F_a is added, displacement increases by exactly δ_a for bearing I, and decreases for bearing II. At this time bearings I and II become balanced by the loads of F_I and F_{II} respectively. The amount of displacement of bearing I when external force F_a is applied without preload is δ_b , which is quite a bit larger than δ_a . In other words, this shows that rigidity is enhanced by preload.

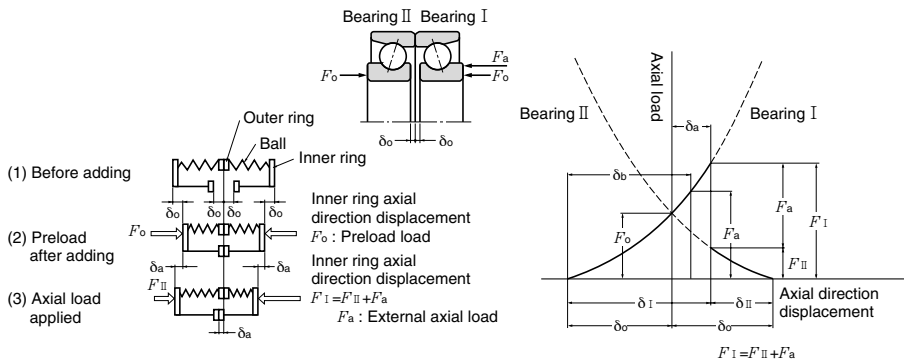

Fig. 9.3 Fixed Position Preload Model Diagram and Preload Line Diagram

9.4 Correlation of Axial and Radial Internal Clearance for Deep Groove Ball Bearings

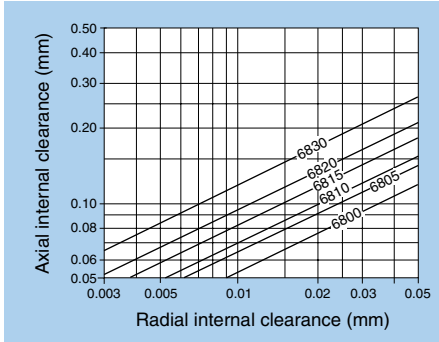

Fig. 9.4.1 Axial and Radial Internal Clearance for 68 Series

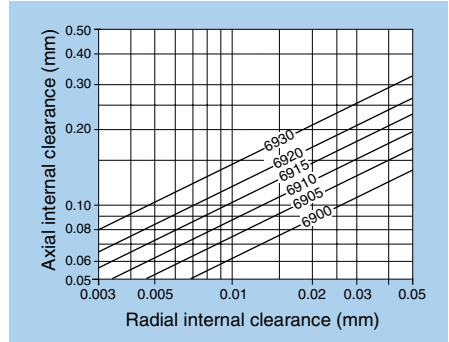

Fig. 9.4.2 Axial and Radial Internal Clearance for 69 Series

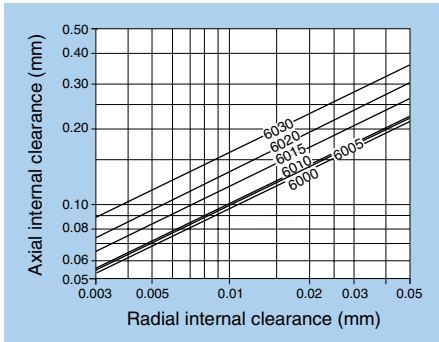

Fig. 9.4.3 Axial and Radial Internal Clearance for 60 Series

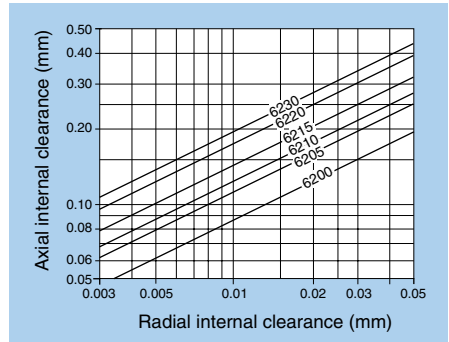

Fig. 9.4.4 Axial and Radial Internal Clearance for 62 Series

※ Technical data is based on typical figures. The values therefore cannot be guaranteed.

9.5 Axial Load and Displacement of Angular Contact Ball Bearings

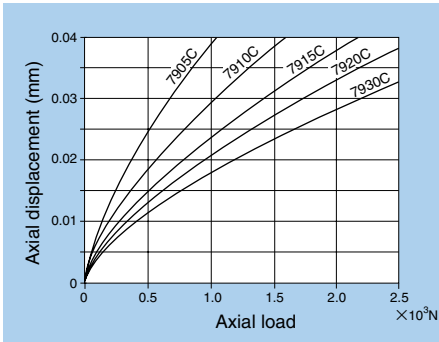

Fig. 9.5.1 Axial Load and Displacement for 79C Series

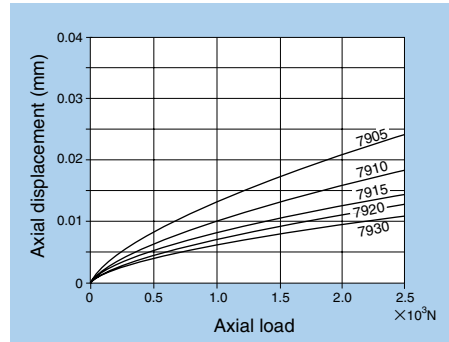

Fig. 9.5.2 Axial Load and Displacement for 79 Series

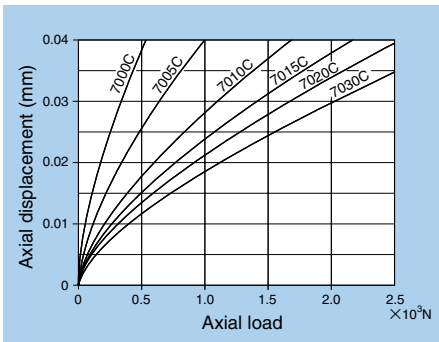

Fig. 9.5.3 Axial Load and Displacement for 70C Series

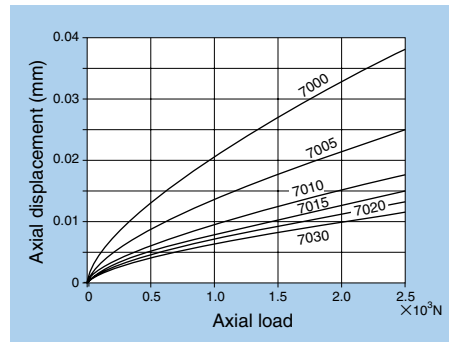

Fig. 9.5.4 Axial Load and Displacement for 70 Series

※ Technical data is based on typical figures. The values therefore cannot be guaranteed.

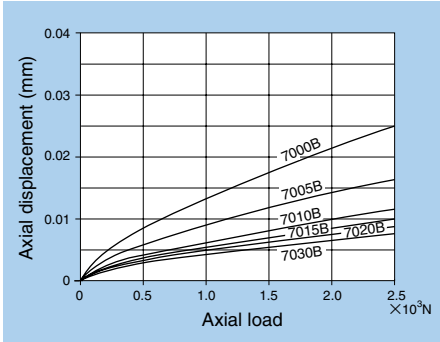

Fig. 9.5.5 Axial Load and Displacement for 70B Series

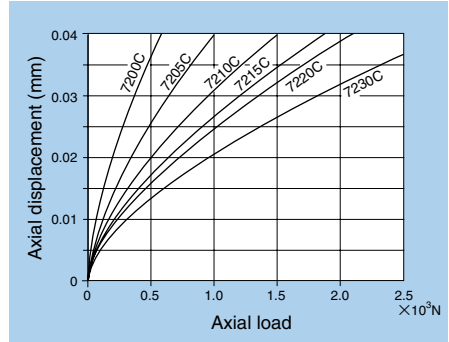

Fig. 9.5.6 Axial Load and Displacement for 72C Series

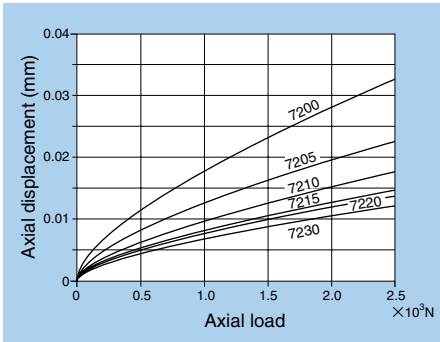

Fig. 9.5.7 Axial Load and Displacement for 72 Series

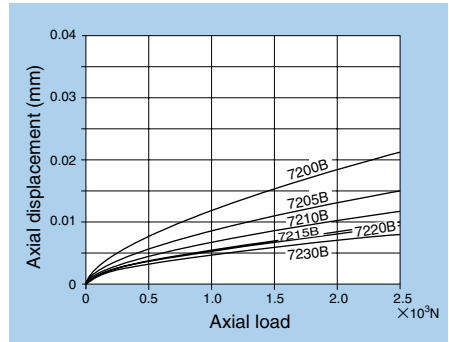

Fig. 9.5.8 Axial Load and Displacement for 72B Series

※Technical data is based on typical figures. The values therefore cannot be guaranteed.

9.6 Axial Load and Displacement for Tapered Roller Bearings

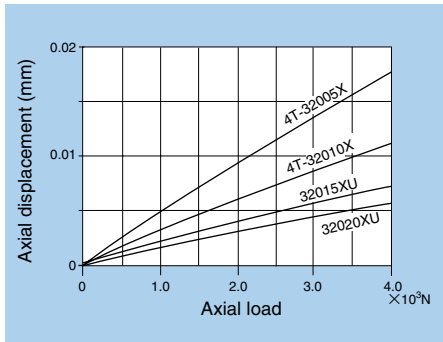

Fig. 9.6.1 Axial Load and Displacement for 320 Series

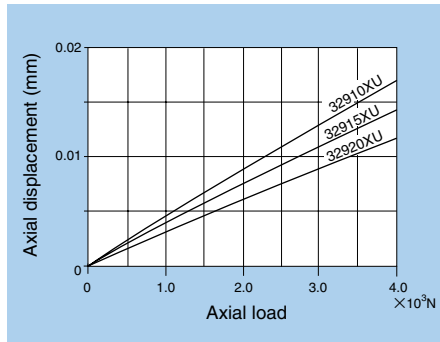

Fig. 9.6.2 Axial Load and Displacement for 329 Series

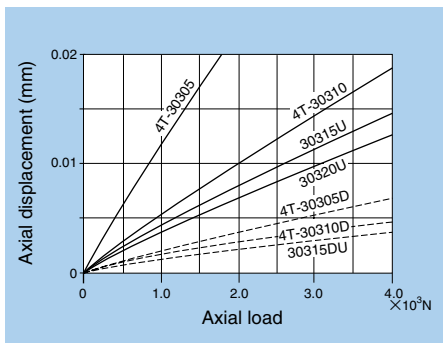

Fig. 9.6.3 Axial Load and Displacement for 303 Series, 303D Series

※ Technical data is based on typical figures. The values therefore cannot be guaranteed.

10. Allowable Speed

As rotational speed of the bearing becomes larger, bearing temperature rises due to friction produced inside the bearing, producing damage such as seizure, making continued stable operation impossible. Allowable speed is the rotational speed limit at which the bearing can perform. Allowable speed differs according to bearing type, dimensions, precision, clearance, type of cage, load conditions, lubrication conditions, and various other factors.

The catalog dimensions table gives allowable speed standards for grease and oil lubrication, but allowable speed is based on the following conditions:

- Bearing of proper internal design and clearance is correctly mounted.
- Suitable lubricant is used, and is properly replenished or replaced.
- Normal operating temperature under normal load conditions ($P \leq 0.09 Cr, Fa/Fr \leq 0.3$).

Correction is necessary if load is large (see **Figs. 10.1** and **10.2**). For sealed bearings, speed is determined by peripheral speed of the seal contact section. If a radial bearing is used for a vertical shaft, there are disadvantages concerning lubrication maintenance and cage guide, so about 80% of the allowable speed is suitable. If using in excess of the allowable speed, you must reconsider bearing specifications and lubrication conditions.

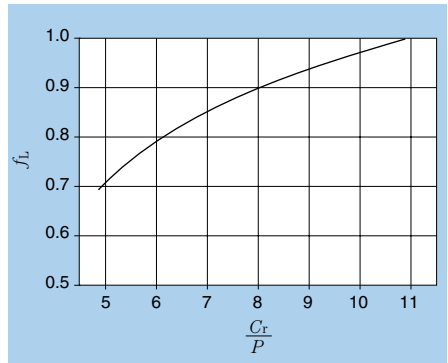

Fig. 10.1 Value of Correction Factor f_1 by Bearing Load

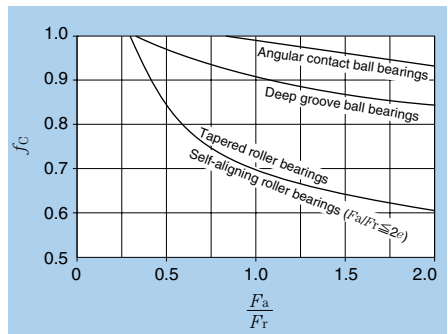

Fig. 10.2 Value of Correction Factor f_2 by Combined Radial and Axial Load

or Bearing (25/100)

Products Found From electronic catalog

Cylindrical Roller Brg.

Number	d (mm)	D (mm)	B (mm)	Cr (kN)	Limiting speeds	
					Grease (rpm)	Oil (rpm)
P24	20,000	47,000	14,000	15.4	17000	20000
P204	20,000	47,000	14,000	15.4	17000	20000
04	20,000	47,000	14,000	15.4	17000	20000
204	20,000	47,000	14,000	15.4	17000	20000
204k	20,000	47,000	14,000	25.7	15000	18000
204k	20,000	47,000	14,000	25.7	15000	18000

~55mm

See page B-94 of the Ball and Roller Bearings catalog.

Boundary dimensions		Basic load ratings				Limiting speeds*			Bearing numbers					
D	B	r_{1max}	r_{2max}	dynamic	static	dynamic	static	rpm			type NU	type NJ	type NUP	type N
				C_1	C_0	C_2	C_0	grease	oil					
75	16	1	0.6	31.0	34.0	3,200	3,450	9,900	12,000		NU1009	NJ	NUP	N
85	19	1.1	1.1	46.0	47.0	4,700	4,900	8,400	9,900		NU209	NJ	NUP	N
85	19	1.1	1.1	63.0	66.5	6,450	6,800	7,600	9,000		NU209E	NJ	NUP	—

11. Bearing Characteristics

11.1 Friction

One characteristic of rolling bearings is that they produce less friction than sliding bearings, particularly starting friction. Friction of rolling bearings involves a variety of factors.

- Friction that accompanies rolling (load)
- Sliding friction between cage and rolling elements, and cage and guide surface
- Sliding friction between roller end faces and guide rib
- Friction of lubricant or sealing device

The friction factor for rolling bearings is generally expressed by the following equation.

$$\mu = \frac{2M}{Pd} \dots\dots\dots (11.1)$$

Where:

- μ : Friction factor
- M : Friction moment N·mm {kgf·mm}
- P : Bearing load N {kgf}
- d : Bearing bore mm

The dynamic friction factor for rolling bearings is affected by various factors as mentioned before. Dynamic friction factor also differs according to rotational speed as well as bearing type. Values are generally taken from

Table 11.1

Table 11.1 Friction Factor for Bearings

Bearing type	Friction factor $\mu \times 10^{-3}$
Deep groove ball bearings	1.0~1.5
Angular contact ball bearings	1.2~1.8
Self-aligning ball bearings	0.8~1.2
Cylindrical roller bearings	1.0~1.5
Needle roller bearings	2.0~3.0
Tapered roller bearings	1.7~2.5
Self-aligning roller bearings	2.0~2.5
Thrust ball bearings	1.0~1.5
Thrust roller bearings	2.0~3.0

11.2 Temperature Rise

Almost all friction loss is converted to heat inside the bearing, causing the temperature of the bearing itself to rise. The amount of heat produced by friction moment is expressed by equation 11.2.

$$Q = 0.105 \times 10^{-6} M \cdot n \text{ N} \\ = 1.03 \times 10^{-6} M \cdot n \text{ {kgf}} \dots\dots(11.2)$$

Where:

- Q : Amount of heat produced kW
- M : Friction moment N·mm {kgf·mm}
- n : Rotational speed of bearing rpm

Bearing temperature is determined by the balance of the amount of heat produced and the amount of heat released.

In most cases temperature rises sharply during the initial stages of operation, and then stabilizes to a somewhat lower temperature after a certain amount of time elapses. The amount of time it takes to reach this constant temperature differs according to various conditions such as bearing size, type, rotational speed, load, lubrication, and heat release of the housing. If constant temperature is never reached, it is assumed that there is something wrong. Possible causes are as follows:

- Insufficient bearing internal clearance or excessive preload.
- Bearing is mounted improperly.
- Excessive axial load due to heat expansion or improper mounting of the bearing.
- Excess/lack of lubricant, improper lubricant.
- Heat is being generated from the sealing device.

Data concerning temperature rise due to load or rotational speed is provided for your reference. (See **Figs. 11.1** and **11.2** on the following page)

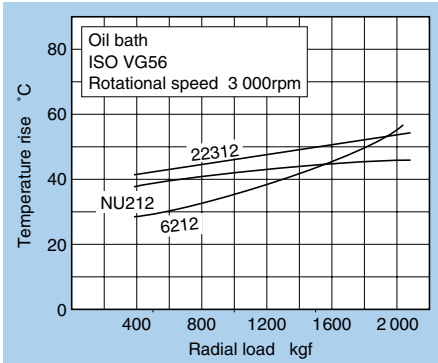

Fig. 11.1 Radial Load and Temperature Rise

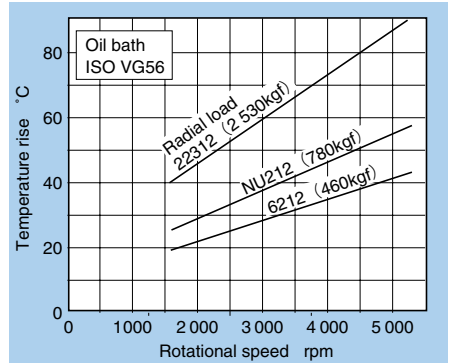

Fig. 11.2 Rotational Speed and Temperature Rise

11.3 Sound

When the inner or outer ring of the bearing turns, the rolling elements roll along the raceway surface accompanying the cage, thus producing various sounds and vibrations. In other words, vibration and sound is produced according to shape and roughness of the rolling surface and sliding parts, and the lubrication status.

With improved quality in various fields, including the data equipment field, the demand for less vibration and sound has escalated in recent years. It is rather difficult to express sound, but a list of typical abnormal sounds produced by bearings is given in **Table 11.2**.

One-Point Advice

Bearing Tips

● **What is rolling friction?**

They say it is theoretically extremely difficult to measure pure rolling friction where difference in speed of two surfaces must be zero.

In actuality, however, the influence of pure rolling friction is extremely small compared to other factors involved in rolling bearings (such as friction between the cage and rolling elements, agitation resistance of the lubricant), and is usually ignored.

Friction is however produced between two surfaces by rolling, and there is an intimate connection between rolling and sliding friction.

Various past experiments suggest that the rolling friction factor is approximately between 0.00001 and 0.001.

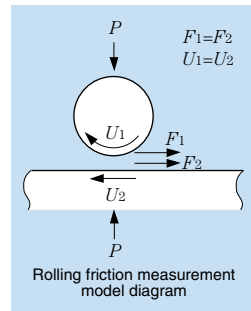

Table 11.2 Abnormal Sound Characteristics and Related Factors

Sound	Characteristics	Related factors
Swoosh Swoop	Sound quality does not change when rotational speed changes (dirt). Sound quality changes when rotational speed changes (Flaw).	Dirt. Surfaces of raceway, balls or rollers is rough. Damage of raceway, balls or roller surface.
Sssss	Small bearing	Surface roughness of raceway, balls or rollers.
Hiss	Produced intermittently as a rule.	Contact with labyrinth. Contact with cage and seal.
Growl (Moaning sound)	Size and height changes when rotational speed changes. Loud sound is produced at certain rpm. Sound becomes louder and softer. Sounds sometimes like siren or whistle.	Resonance, improper fit (improper shaft shape). Deformation of bearing rings. Chatter of raceway surface, balls or rollers (in the case of large bearings, a small amount of chatter is normal).
Scratch	Sensed when turned manually.	Scratching of raceway surface (regular). Scratching of balls or rollers (irregular). Dirt, deformation of bearing rings (negative clearance in places).
Roll Rumble	Large bearings) Continuous sound Small bearings) according to high speed.	Scratching of raceway surface, surface of balls or rollers.
Whirr	Stops as soon as power is turned off.	Electromagnetic sound of motor.
Crackle	Occurs irregularly (Doesn't change when rotational speed is altered). Primarily applies to small bearings.	Dirt in bearing.
Pitter-patter Flap flap) Flutter)	Tapered roller bearings) Large bearings) Regular continuous Small bearings) sound at high speed.	Clear sound from cage is normal. Improper grease at low temperature → grease should be soft. Operation with cage pocket wear, insufficient lubrication, insufficient bearing load.
Click Clack	Noticeable at low speed. Continuous sound at high speed.	Sound of impact in cage pocket; insufficient lubrication. Eliminated by decreasing clearance or applying preload. Mutual impact of full complement rollers.
Crack Clang	Loud metallic impact sound. Low-speed, thin-wall large bearings (TTB), etc.	Sound of rolling elements popping.
Urrr	Primarily cylindrical roller bearings; changes when rotational speed is altered. Sounds metallic if loud. Stops temporarily when grease is replenished.	Large consistency of lubricant (grease). Excessive radial clearance. Insufficient lubrication.
Squeak Screech	Sound of crunching between metals. High-pitched sound.	Crunching between rollers and rib surface of roller bearings. Insufficient lubrication
Pip pop	Occurs irregularly in small bearings.	Sound of air bubbles in the grease being smashed.
Krak	Squeaking sound produced irregularly.	Sliding of fit sections. Squeaking of mounting surfaces.
Sound pressure is generally too large.		Surface of raceway, balls or roller is rough. Deformation of raceway surface, balls or rollers due to wear. Clearance has been enlarged due to wear.

12. Lubrication

The objective of lubricating a bearing is to form a film of oil on the rolling and sliding surfaces to prevent metal parts from making direct contact with each other. Lubrication provides the following effects.

- Reduces friction and wear
- Discharges friction heat
- Extends bearing life
- Prevents rust
- Prevents foreign material from getting inside

In order to get the most from the lubricant, you must choose a lubricant and lubrication method that suits your usage conditions, and must make use of sealing devices for preventing dirt from getting in and lubricant from leaking out.

12.1 Grease Lubrication

Grease is widely used because it is easy to handle, it facilitates sealing device design, and is the most economical lubricant. Lubrication methods include sealed bearings where the grease is sealed inside the bearing in advance, and the method of filling an open bearing and housing with grease, and replenishing or replacing the grease at fixed intervals.

(1) Types of grease

Grease is hardened to a semi-solid by adding thickener to base oil (mineral oil or synthetic fluid), and then augmented by additives such as oxidation stabilizers, extreme-pressure additives and rust-preventive agents.

The nature of the grease therefore varies according to the types and combinations.

An example is given in **Table 12.1**.

Table 12.1 Grease Types and Characteristics

Name	Lithium grease			Non-soap grease	
	Li soap				
Thickener	Li soap			Bentone, silica gel, urea, carbon black, fluorine compounds, etc.	
Base oil	Mineral oil	Diester oil	Silicon oil	Mineral oil	Synthetic oil
Dropping point (°C)	170 ~ 190	170 ~ 190	200 ~ 250	250 or more	250 or more
Operating temperature range (°C)	-30 ~ +130	-50 ~ +130	-50 ~ +160	-10 ~ +130	-50 ~ +200
Mechanical stability	Superior	Good	Good	Good	Good
Pressure resistance	Good	Good	Poor	Good	Good
Water resistance	Good	Good	Good	Good	Good
Applications	Largest range of applications. All-purpose grease for rolling bearings.	Superior low-temperature and friction characteristics. Suitable for small and miniature bearings.	Suitable for high and low temperatures. Has low oil film strength, and is therefore not suitable for large loads.	Can be used in a wide range of temperatures, from low to high. Exhibits superior heat, cold and chemical resistance characteristics through proper combination of base oil and thickener. All-purpose grease for rolling bearings.	

Consistency is the standard used by JIS for expressing softness of grease. The smaller the consistency number, the softer and more fluid is the grease. (See **Table 12.2**)

Main grease brands and nature table are given in **Table 12.3** on page 60. Nature is lost by mixing greases of different types. This must be avoided.

Table 12.2 Grease Consistency

NLGI consistency No.	JIS (ASTM) 60-times mixing consistency	Application
0	355~385	Concentrated greasing
1	310~340	Concentrated greasing
2	265~295	General purpose, sealed bearings
3	220~250	General purpose, high temperature
4	175~205	Special purpose

■ Solid grease (for polyube bearing)

Solid grease is a mixture of ultra high polymer polyethylene and lubricating grease, which is hardened by heating after sealing in the bearing. The lubricant is maintained inside polyethylene, so there is minimal leaking of the lubricant. The lubricant itself has no fluidity, so spot-pack specifications are characterized by small torque. This is also connected with preventing dirt from entering and soiling of the surrounding area by grease discharge. If used at high temperatures, however, discharge of oil increases, thus shortening lubrication life. Precautions therefore must be taken for high-speed operation or when using in high temperatures. Packing examples are shown in **Figs. 12.1** and **12.2**. **Photographs 12.1** and **12.2** were taken with the aid of an electron microscope.

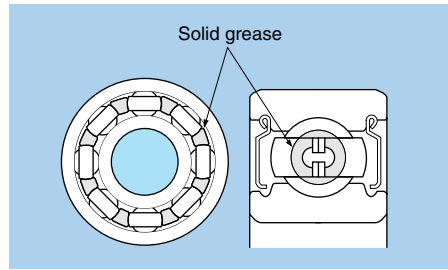

Fig. 12.1 Deep groove ball bearing spot pack specifications

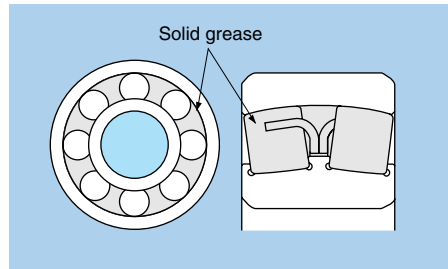
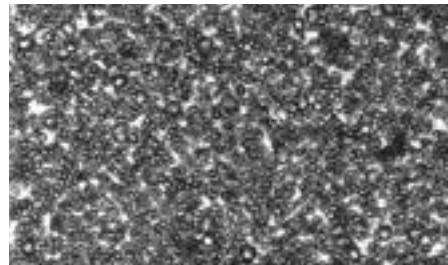
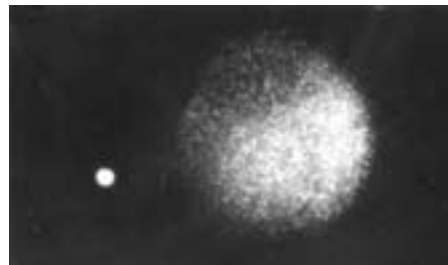

Fig. 12.2 Full pack specifications for self-aligning roller bearings



Photograph 12.1 Unhardened state photographed through electron microscope



Photograph 12.2 Heated polyethylene particle in oil
The white spot on the left is the size of the polyethylene particle prior to heating

(2) Grease filling and replacement

The amount of grease it takes to fill the bearing differs according to housing design, space volume, rotational speed, and grease type. The standard for filling is 30 to 40% of the bearing space volume, and 30 to 60% of space volume for the housing.

Use less grease if rotational speed is high, or you want to hold down the temperature. Too much grease could cause temperature to rise, grease to leak, or performance to decrease due to deterioration. Be careful not to overfill the bearing with grease. Approximate value for space volume in the bearing is calculated by equation 12.1.

$$V = K \cdot W \dots\dots\dots (12.1)$$

Where:

- V : Space volume of an open bearing (approximate value) (cm³)
- K : Bearing space factor (see **Table 12.4**)
- W : Bearing mass (kg)

Performance of grease deteriorates with the passing of time. Grease must therefore be

replenished at suitable intervals. Replenishment interval differs according to bearing type, dimensions, rotational speed, temperature and type of grease. The standard is given in **Fig. 12.3**. This is however under normal operating conditions. Grease is also largely affected by temperature. When the bearing temperature rises above 80°C, make the replenishment interval 1/1.5.

Table 12.4 Bearing Space Factor K

Bearing type	Cage type	K
Deep groove ball bearing ①	Pressed cage	61
NU type cylindrical roller bearing ②	Pressed cage	50
	Machined cage	36
N type cylindrical roller bearing ③	Pressed cage	55
	Machined cage	37
Tapered roller bearing	Pressed cage	46
Self-aligning roller bearing	Pressed cage	35
	Machined cage	28

- ① 160 Series bearings not included.
- ② NU4 Series bearings not included.
- ③ N4 Series bearings not included.

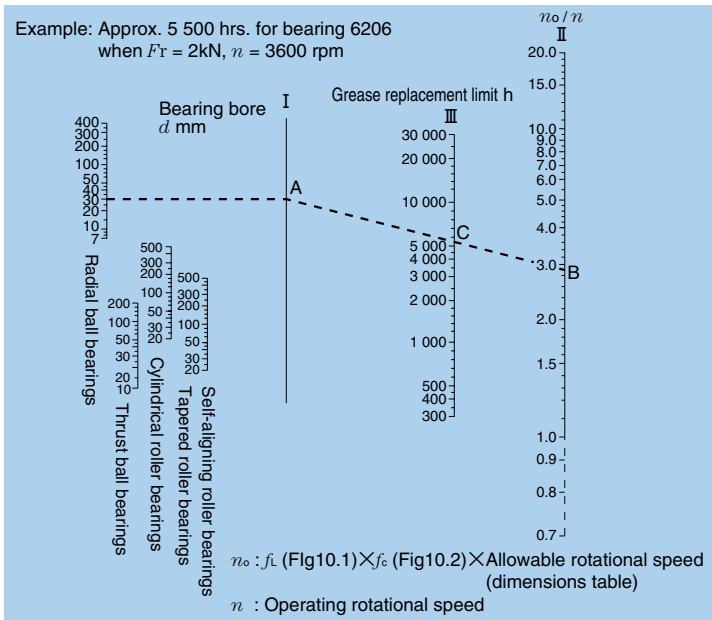

Fig. 12.3 Diagram for Determining Grease Replenishment Interval

Table 12.3 Grease Brands and Nature Table

Maker	Brand	NTN No.	Thickener	Base oil
Showa Shell Sekiyu	Alvania Grease 2	2A	Lithium	Mineral oil
	Alvania Grease 3	3A	Lithium	Mineral oil
	Alvania Grease RA	4A	Lithium	Mineral oil
	Alvania EP Grease 2	8A	Lithium	Mineral oil
	Aeroshell Grease 7	5S	Micro gel	Diester oil
Kyodo Yushi	Multemp PS No.2	1K	Lithium	Diester oil
	Multemp SRL	5K	Lithium	Tetraesterdiester oil
	Multemp PSK	7K	Lithium	Diester mineral oil
	E5	L417	Urea	Ether
Esso Sekiyu	Andok C	1E	Natrium compound	Synthetic hydrocarbon
	TEMPREX N3/Unirex N3	2E	Lithium compound	Synthetic hydrocarbon
	BEACON 325	3E	Lithium	Diester oil
NOK CLUBER	Isoflex Super LDS 18	6K	Lithium	Diester oil
	Barrierta JFE552	LX11	Fluorine	Fluorine oil
	Grease J	L353	Urea	Ester
Toray, Dow Corning, Silicone	SH33L	3L	Lithium	Methyl/phenol oil
	SH44M	4M	Lithium	Methyl/phenol oil
Nippon Oil	Multinoc Wide No.2	6N	Lithiumnatrium	Diester mineral oil
	U-4	L412	Urea	Synthetic hydrocarbon + dialkyl diphenyl ether
Nippon Grease	MP-1	L448	Diurea	PAO+Ester
Idemitsukosan	Apolloil Autolex A	5A	Lithium	Mineral oil
Mobil Sekiyu	Bobil Grease 28	9B	Bentone	Synthetic hydrocarbon
Cosmo Oil	Cosmo Wide Grease WR3	2M	Na terephthalate	Diester mineral oil
Daikin Industries	Demnum L200	LX23	PTFE	Fluorine oil

Base oil viscosity		Consistency	Dropping point (°C)	Operating temperature (°C)	Color	Characteristics
37.8°C	140mm ² /s	273	181	-25~120	Amber	All-purpose grease
37.8°C	140mm ² /s	232	183	-25~135	Amber	All-purpose grease
37.8°C	45mm ² /s	252	183	-40~120	Amber	For low temperatures
98.9°C	15.3mm ² /s	276	187	-20~110	Brown	All-purpose extreme-pressure
98.9°C	3.1mm ² /s	288	Min. 260	-73~149	Tan	MIL-G-23827
37.8°C	15.3mm ² /s	265~295	190	-55~130	White	For low temperatures low torque
40°C	26mm ² /s	250	192	-40~150	White	Wide range
37.8°C	42.8mm ² /s	270	190	-40~130	White	1K improved rust prevention
40°C	72.3mm ² /s	300	240	-30~180	White	For high temperatures
40°C	97mm ² /s	205	260	-20~120	Brown	Min. grease leak, retainer noise
40°C	113mm ² /s	220~250	Min. 300	-30~160	Green	For high temperatures
40°C	11.5mm ² /s	265~295	177	-60~120	Brown	For low temperatures low torque
40°C	16.0mm ² /s	265~295	Min. 180	-60~130	Yellow-green	For low temperatures low torque
40°C	400mm ² /s	290	—	-35~250	White	—
40°C	75mm ² /s	—	280	-20~180	Off-white	For high temperatures
25°C	100mm ² /s	300	200	-70~160	Reddish gray	Does not lubricate well at low temperatures
40°C	32mm ² /s	260	210	-40~180	Brown	Does not lubricate well at high temperatures
37.8°C	30.9mm ² /s	265~295	215	-40~135	Light tan	Wide range
40°C	58mm ² /s	255	260	-40~180	Milk	For high temperatures
40°C	40.6mm ² /s	243	254	-40~150	Light tan	Wide range
37.8°C	50mm ² /s	265~295	192	-25~150	Yellow	All-purpose grease
40°C	28mm ² /s	315	Min. 260	-62~177	Red	MIL-G-81322C Wide range
37.8°C	30.1mm ² /s	265~295	Min. 230	-40~150	Light tan	Wide range
40°C	200mm ² /s	280	—	-60~300	White	—



12.2 Oil Lubrication

Along with facilitating lubrication of rolling and sliding parts inside the bearing, oil lubrication functions to eliminate heat

produced from inside and outside the bearing. There are various methods of providing oil lubrication. The main ones are given in **Table 12.5**.

Table 12.5 Oil Lubrication Method

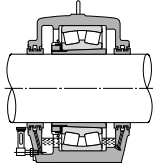
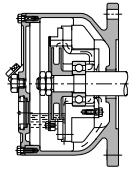
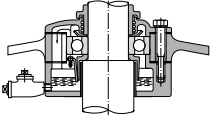
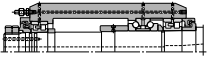
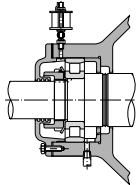
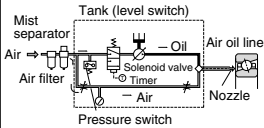
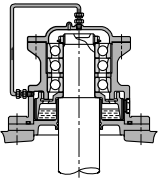
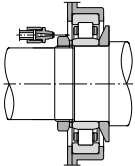
Lubrication method	Example	Lubrication method	Example
<p>Oil bath lubrication</p> <ul style="list-style-type: none"> Oil bath lubrication is the most common method of lubrication and is widely used for low to moderate rotation speed applications. For horizontal shaft applications, oil level should be maintained at approximately the center of the lowest rolling element, according to the oil gauge, when the bearing is at rest. For vertical shafts at low speeds, oil level should be maintained at 50 - 80% submergence of the rolling elements. 		<p>Disc lubrication</p> <ul style="list-style-type: none"> With this method, part of the disc mounted on the shaft is submerged in oil, and the bearing is lubricated by oil springing upward. 	
<p>Oil spray lubrication</p> <ul style="list-style-type: none"> With this method, an impeller or similar device mounted on the shaft draws up oil and sprays it on the bearing. This method can be used at considerably high speeds. 		<p>Oil mist lubrication</p> <ul style="list-style-type: none"> The bearing is lubricated by oil mist propelled by pressurized air. Low resistance of lubricating oil makes this method suitable for high-speed rotation. Produces a lot of atmospheric pollution. 	
<p>Drip lubrication</p> <ul style="list-style-type: none"> With this method, oil collected above the bearing is allowed to drip down into the bearing where it changes to a mist as it comes in contact with the rolling elements in the housing. Another version allows only a slight amount of oil to pass through the bearing. Used at relatively high speeds for light to moderate loads. In most cases, oil volume is a few drops per minute. 		<p>Air-oil lubrication</p> <ul style="list-style-type: none"> With this method, the minimum required amount of oil is measured out and fed by compressed air to each bearing at the optimal interval. Bearing temperature can be minimized by constant supply of fresh lubricating oil to the bearing, coupled with the cooling effect of compressed air. Only an extremely small amount of oil is required, resulting in less pollution released into the atmosphere. 	
<p>Circulating lubrication</p> <ul style="list-style-type: none"> Used for bearing cooling applications or for automatic oil supply systems in which oil supply is centrally located to many portions. Features clean maintenance of lubricating oil if the lubrication system is provided with a cooler to cool the lubricating oil, or a filter is used. Provided on mutually opposing side relative to the oil inlet and outlet of the bearing so that the oil reliably lubricates the bearing. 		<p>Oil jet lubrication</p> <ul style="list-style-type: none"> Lubricates by high-pressure injection of oil from the side of the bearing. Provides high reliability under harsh conditions such as high speeds and high temperatures. Used for lubricating main bearings in jet engines, gas turbines and other high-speed equipment. Under-race lubrication for machine tools is one example of this type of lubrication. 	

(1) Selection of lubricating oil

Various mineral oils such as spindle oil, machine oil and turbine oil are used as lubricating oil. For high temperature of 150°C and above, and low temperatures of -30°C and below, however, synthetic oils such as diester oil, silicone oil and fluorocarbon oil are used. Viscosity of lubricating oil is an important characteristic that determines lubricating performance. If viscosity is too low, oil film does not form sufficiently, resulting in damage to the bearing surface. On the other hand, if viscosity is too high, viscosity resistance becomes large, causing temperature to rise and friction loss to increase. Generally, the higher the rotational speed, the lower the viscosity should be, and the heavier the load is, the higher viscosity should be.

The viscosity required for lubrication of rolling bearings at this operating temperature is given in **Table 12.6**. The correlation of viscosity and temperature is given in **Fig. 12.4**. **Table 12.7** gives standards for selecting lubricating oil viscosity according to bearing operating conditions.

Table 12.6 Viscosity Required for Bearings

Bearing type	Viscosity mm ² /s
Ball bearings, cylindrical roller bearings, needle roller bearings	13
Self-aligning roller bearings, tapered roller bearings, thrust needle roller bearings	20
Self-aligning thrust roller bearings	30

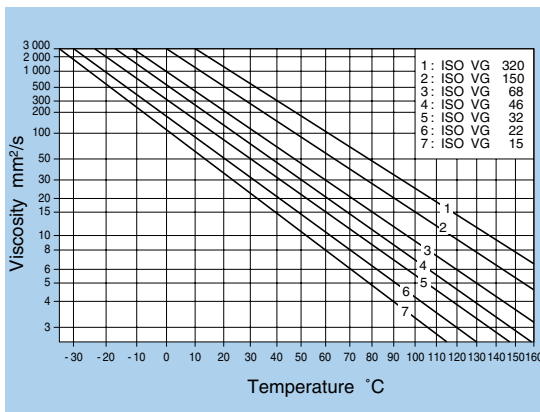

Fig. 12.4 Correlation of Temperature and Viscosity of Lubricating Oil

Table 12.7 Standard for Selecting Lubricating Oil

Bearing operating temperature °C	dn Value	ISO viscosity grade of lubricating oil (VG)		Applicable bearings
		Normal load	Heavy or shock load	
-30~ 0	Up to allowable rpms	22, 32	46	All types
0~ 60	15 000 Up to	46, 68	100	All types
	15 000 ~80 000	32, 46	68	All types
	80 000 ~150 000	22, 32	32	All bearings except thrust ball bearings
	150 000~500 000	10	22, 32	Single row radial ball bearings, cylindrical roller bearings
60~100	15 000 Up to	150	220	All types
	15 000 ~80 000	100	150	All types
	80 000 ~150 000	68	100, 150	All bearings except thrust ball bearings
	150 000~500 000	32	68	Single row radial ball bearings, cylindrical roller bearings
100 ~150	Up to allowable rpms	320		All types
0~ 60	Up to allowable rpms	46, 68		Self-aligning roller bearings
60~100	Up to allowable rpms	150		

Remarks 1: When the lubrication method is oil bath or circulating lubrication.

(2) Oil quantity

When lubrication is forcibly fed to the bearing, the amount of heat generated from the bearing, etc. equals the sum of the radiant heat given off by the housing and heat given off by the oil. The quantity of oil required for a standard housing is calculated by the equation 12.2.

$$Q = K \cdot q \quad \dots\dots\dots (12.2)$$

Where

- Q : Quantity of oil supplied per bearing (cm³/min)
- K : Allowable oil temperature rise factor (see **Table 12.8**)
- q : Oil quantity according to diagram (cm³/min) (**Fig. 12.5**)

Table 12.8 K value

Discharge oil temperature minus supplied oil temperature (°C)	K
10	1.5
15	1
20	0.75
25	0.6

In the case of actual operation, it is safe to adjust the oil supply quantity to meet the amount that is adequate for the actual situation because the sum of the radiant heat varies depending on the housing shape by referring to the calculated value as a guideline. Assuming that the oil carries away all the generated heat in **Fig. 12.5**, the oil supply quantity should be calculated as the shaft diameter $d = 0$.

The oil replacement limit in the oil bath lubrication may vary depending on the using condition, oil quantity or lubricant type. It is recommended to replace the oil around once a year if the oil is used in the range lower than 50°C, and at least every three months in the case of range between 80 and 100°C.

Example:
 Bearing type 30220U, $F_r = 9.5$ kN, $n = 1800$ rpm
 Example when bearing temperature rise held to 15°C for oil supply temperature.

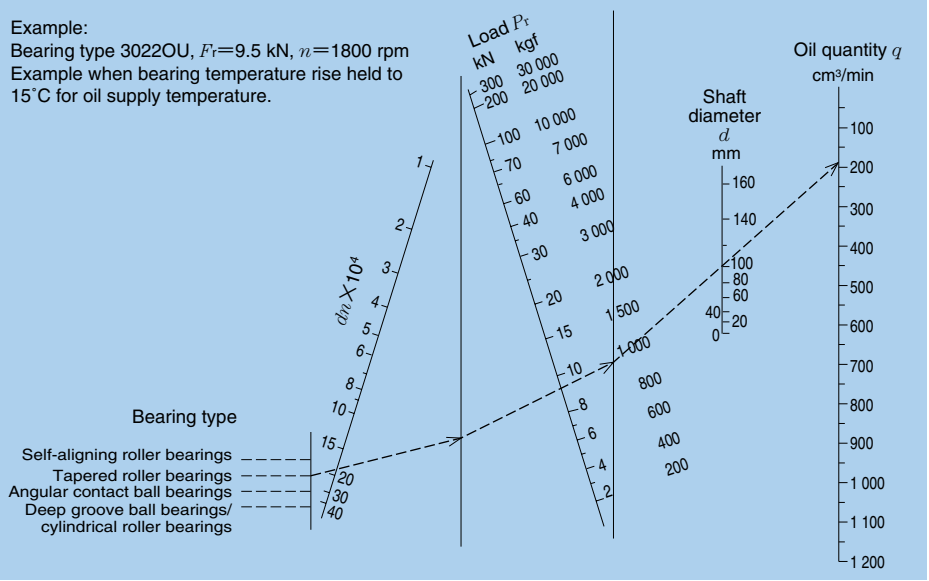

Fig. 12.5 Oil Supply Quantity Diagram

13. External Bearing Sealing Devices

The objective of sealing devices is to prevent lubricant from leaking out of the bearing and prevent dirt and water from getting inside the bearing. Sealing devices work well to seal and make the bearing dust-proof for various operating conditions. Sealing devices are durable - they produce little friction and no abnormal heat. They are also good for applications requiring ease of assembly.

Sealing devices are roughly divided into non-contact seals and contact seals. Seals can also be used in various combinations, the most common of which are given in

Table 13.1.



Table 13.1 Main Seal Construction and Characteristics

Type	Seal construction	Name	Seal characteristics
Non-contact seal		Clearance seal	Extremely simple seal design with small radial clearance.
		Oil groove seal (Oil grooves on housing side)	Several concentric oil grooves are provided on the housing inner diameter to greatly improve the sealing effect. When the grooves are filled with lubricant, the intrusion of contaminants from the outside is prevented.
		Oil groove seal (Oil grooves on shaft and housing side)	Oil grooves are provided on both the shaft outer diameter and housing inner diameter to form a more efficient seal.
		Radial labyrinth seal	Seal where labyrinth passages are formed in the radial direction. Used for housing vertically divided in two. Provides better sealing than axial labyrinth seals.
		Internal slinger in housing	The housing is provided with a slinger. The centrifugal force of the turning slinger prevents lubricant from leaking out.
Contact seal		Z grease seal	Contact seal has a Z-shaped cross-section. The hollow portion is packed with grease to form a grease seal. Often used for plummer blocks.
		Oil seal	Contact seals are generally used as oil seals. The type and dimensions are standardized by ISO 6194 (JIS B 2402). Sealing effect is enhanced by a ring-shaped spring mounted on the lip of the oil seal, which presses the lip edge against the shaft surface. If the bearing and oil seal are close to each other, heat produced from the oil seal may cause internal clearance of the bearing to be insufficient. Select bearing internal clearance with proper regard for heat produced from the oil seal due to peripheral speed. Depending upon orientation, the seal functions to prevent lubricant from leaking out the bearing, or foreign matter from getting inside.
Combination seals		Oil groove seal + slinger + Z grease seal	In order to enhance performance, some Z grease seals include an oil groove seal and slinger. The figure on the left shows triple seal construction for prevention intrusion of foreign matter by seal orientation. Used for mining equipment and plummer blocks and other places exposed to excessive dust.

14. Bearing Materials

14.1 Bearing ring and Rolling element materials

When a rolling bearing turns while receiving a load, a lot of stress is repeatedly placed on the small contact surface of the bearing rings and rolling elements, and the bearing must maintain high precision while rotating. That means bearing materials must satisfy the following demands.

- Must be hard.
- Rolling fatigue life must be long.
- Wear must be slight.
- Must be shock-resistant.
- Dimensions must not vary largely with the passing of time.
- Must be economical and easy to machine.

Among the things that affect rolling fatigue life most are non-metallic debris in steel.

Various steel manufacturing methods have been developed to reduce non-metallic debris, which have contributed to enhancing life.

The same materials are generally used for bearing rings and rolling elements, especially high carbon chrome bearing steel. The chemical constituents of the various types of steel have been standardized by ISO 683 (JIS G 4805). The composition table for the most frequently used material, SUJ2, is given in **Table 14.1**.

Table 14.1 High Carbon Chrome Bearing Steel (ISO 683 (JIS G 4805))

Steel type code	Chemical composition %					
	C	Si	Mn	P	S	Cr
SUJ2	0.95~ 1.10	0.15~ 0.35	Max. 0.50	Max. 0.025	Max. 0.025	1.30~ 1.60

In addition to this, there is shock-resistant carburized steel whereby the surface is carbon tempered and the core softened to provide it with toughness, high-speed steel used at high temperatures, stainless steel which emphasizes corrosion resistance, ceramics with small specific gravity for ultra

high speed, and plastics used in liquids, each of which is used according to objective.

Dimensions of the same bearing steel are subject to change in high temperatures in excess of 120°C. Development of all kinds of bearings including bearings that are treated to resist dimension change and those whose life has been extended by modified heat treatment and carbon-nitride surface treatment.

14.2 Cage materials

Cages function to correctly retain rolling elements as the bearing turns, but they must also be strong enough to withstand vibration and shock loads while turning, and must be able to withstand operating temperature of the bearing. The cages must also be lightweight and produce little friction between rolling elements and bearing rings.

Pressed cages of cold or hot-rolled steel sheets are often used for small and medium-sized bearings, but stainless steel is also used, depending upon the purpose. Machine structure carbon steel, high strength brass and aluminum alloys are also used for machined cages such as large-sized bearings. If cage strength is required, heat-treated materials of nickel chrome molybdenum (SNCM) are used, and copper and silver plating is used for enhancing lubrication characteristics. In recent years injection molded heat-resistant polyamide reinforced with glass or carbon fibers have come to be used. Plastic cages are lightweight, corrosion-resistant, and have superior attenuation and lubrication characteristics. Teflon cages are sometimes used for high temperatures.

15. Shaft and Housing Design

Bearing performance is largely affected by inclination, deformation and creep according to shaft and housing design. The following are therefore very important.

- Bearing arrangement selection and method of fastening the bearing suited to the selected arrangement
- Suitable shaft and housing fillet radius and shoulder height dimensions, squareness, runout
- Dimensions, shape precision and roughness of fitted parts
- Outer diameter of shaft and housing (including thickness variation)

15.1 Fixing of Bearings

When fastening a bearing to the shaft or housing, the bearing must be fixed in the axial direction as well as fastening by interference with some exceptions. In the case of an axial load, bearing rings may move due to shaft flexure when cylindrical roller bearings are used as the floating side bearing, and must therefore be fixed in the axial direction. Shaft shoulder height should not exceed groove bottom.

The most common methods of fastening are shown in **Fig. 15.1**.

Inner ring fixing	Outer ring fixing	Fixing with snap ring
		
<p>The most common fixing method is to fasten the edge of the bearing ring to the shaft or housing shoulder by nuts or bolts.</p>		<p>Construction is simplified by using a snap ring, but dimensions related to bearing mounting such as interference with chamfers must be considered. Snap rings are not suitable if high precision is required and a large axial load is applied to the snap ring.</p>
Fixing by adapter sleeve		Fixing by withdrawal sleeve
		
<p>When mounting on a cylindrical shaft using an adapter sleeve or withdrawal sleeve, the bearing can be fixed in the axial direction. In the case of an adapter sleeve, the bearing is fixed in place by frictional force between the inside of the sleeve and the shaft.</p>		

Fig. 15.1 Examples of Bearing Fixing Methods

15.2 Bearing Fitting Dimensions

The shaft and housing shoulder height (h) should be larger than the bearing's maximum allowable chamfer dimensions ($r_{s \text{ max}}$), and the shoulder should be designed so that it directly contacts the flat part of the bearing end face. The fillet radius must be smaller than the bearing's minimum allowable chamfer dimension ($r_{s \text{ min}}$) so that it does not

interfere with bearing seating. Dimensions are given in **Table 15.1**.

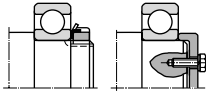
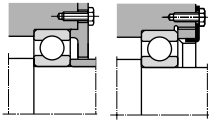
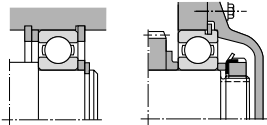
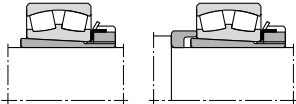
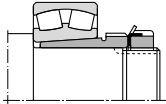
If shaft fillet R is increased in order to enhance shaft strength, and the shaft shoulder dimension is too small, mount with a spacer between the shaft shoulder and bearing. (See **Fig. 15.2**)

Grinding undercut is needed if the shaft is to be grind-finished. Undercut dimensions are given in **Table 15.2**.

Table 15.1 Shoulder Height and Fillet Radius

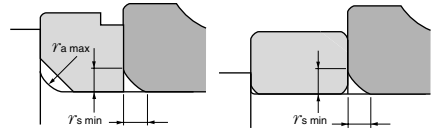
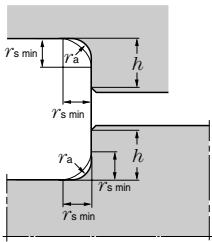

Fig. 15.2 Method Using Spacer

Table 15.2 Grinding Undercut Dimensions

$r_{s \text{ min}}$	Undercut dimensions		
	b	t	r_c
1	2	0.2	1.3
1.1	2.4	0.3	1.5
1.5	3.2	0.4	2
2	4	0.5	2.5
2.1	4	0.5	2.5
2.5	4	0.5	2.5
3	4.7	0.5	3
4	5.9	0.5	4
5	7.4	0.6	5
6	8.6	0.6	6
7.5	10	0.6	7

Unit: mm

$r_{s \text{ min}}$	$r_{a \text{ max}}$	h (Min.)	
		General ①	Special ②
0.05	0.05	0.3	
0.08	0.08	0.3	
0.1	0.1	0.4	
0.15	0.15	0.6	
0.2	0.2	0.8	
0.3	0.3	1.25	1
0.6	0.6	2.25	2
1	1	2.75	2.5
1.1	1	3.5	3.25
1.5	1.5	4.25	4
2	2	5	4.5
2.1	2	6	5.5
2.5	2	6	5.5
3	2.5	7	6.5
4	3	9	8
5	4	11	10
6	5	14	12
7.5	6	18	16
9.5	8	22	20
12	10	27	24
15	12	32	29
19	15	42	38

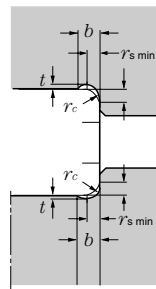

① If a large axial load is applied, shoulder height larger than this value is required.

② Used when axial load is small. The values are not suitable for tapered roller bearings, angular contact ball bearings, and self-aligning roller bearings.

Reference: $r_{a \text{ max}}$ is the maximum allowable value for fillet radius.

15.3 Shaft and Housing Precision

Precision required for normal operating conditions is given in **Table 15.3**, and allowable bearing misalignment for various types of bearings is given in **Table 15.4**.

Using bearings in excess of these limits, bearing life decreases and could damage the cage, etc. Pay special attention to rigidity of the shaft and housing, mounting error resulting from machining precision, and then select bearing type carefully.

Table 15.3 Shaft and Housing Precision

Item		Shaft	Housing
Dimension precision		IT6 (IT5)	IT7 (IT5)
Circularity (max) Cylindricity		IT3	IT4
Shoulder runout tolerance		IT3	IT3
Fit surface roughness	Small bearings	0.8a	1.6a
	Medium to large bearings	1.6a	3.2a

Reference: In the case of precision bearings (precision given on P4 and P5), precision must be kept down to approx. 1/2 for circularity and cylindricity.

Table 15.4 Allowable Bearing Misalignment

Allowable misalignment	
Deep groove ball bearings	1/1 000~1/300
Angular contact ball bearings	
Single row	1/1 000
Double row	1/10 000
Back-to-back	1/10 000
Face-to-face	1/1 000
Cylindrical roller bearings	
Bearing Series 2, 3, 4	1/1 000
Bearing Series 22, 23, 49, 30	1/2 000
Tapered roller bearings	
Single row and back-to-back	1/2 000
Face-to-face	1/1 000
Needle roller bearings	1/2 000
Thrust bearings (excluding self-aligning thrust roller bearings)	1/10 000
Allowable alignment	
Self-aligning ball bearings	1/20
Self-aligning roller bearings	1/50~1/30
Self-aligning thrust roller bearings	1/30

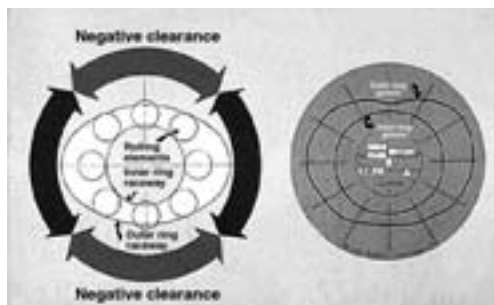

16. Handling

Rolling bearings are precision parts, and must be handled with care to ensure their precision. The following care should be taken:

- Bearings must be kept clean. Dirt affects wear and noise. Be careful of dirt in the air as well.
- Do not expose to strong shocks. Doing so could cause dents or crack the raceway surface. Do not drop or strike with a hammer.
- In order to prevent rust, do not handle with your bare hands. Should be coated with rust preventative, and stored in package in max. relative humidity of 60%.

16.1 Mounting

Remove all dirt, spurs, metal shavings, etc., from the shaft, housing, related parts and mounting fixtures before mounting the bearing. Check the dimension precision, shape precision, and roughness of the mounting section and make sure they are within tolerance. Leave the bearing in its packaging until you are ready to mount it.

In the case of oil lubrication, or even when using grease lubrication, if there is danger of destroying effectiveness of the lubricant by mixing with rust preventatives, remove the rust preventative with detergent oil prior to mounting. If you plan to apply grease after cleaning the bearing, you should dry the bearing somewhat before applying grease. If the bearing is to be inserted on the shaft or in the housing, you must apply equal pressure to the entire circumference of the bearing rings (inner and outer) while inserting. Inserting while applying force to just one part will cause the ring to become cocked to one side. If you apply force to the ring that is not to be inserted, load is applied via the rolling

elements. This could dent the raceway surface, and should absolutely be avoided. Inserting bearing rings by striking directly with a hammer could crack or break the ring, as well as dent it.

(1) Mounting cylindrical bore bearings

As shown in **Fig. 16.1**, bearings with comparatively low interference are press or hammered into place while applying an equal load to the entire circumference of the bearing by positioning the guide on the edge of the bearing ring to be fit. If mounting the inner and outer rings simultaneously, press fit evenly using a metal block as shown in **Fig. 16.2**. In either case, be careful the bearing does not become misaligned when you begin mounting. In some cases a guide is used to prevent misalignment. If interference of the

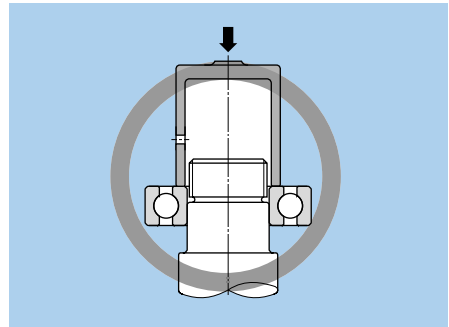

Fig. 16.1 Inner Ring Press Fitting

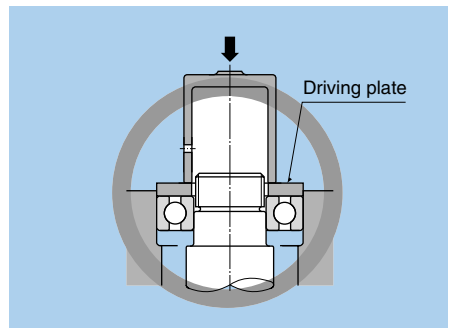

Fig. 16.2 Inner/Outer Ring Simultaneous Press Fitting



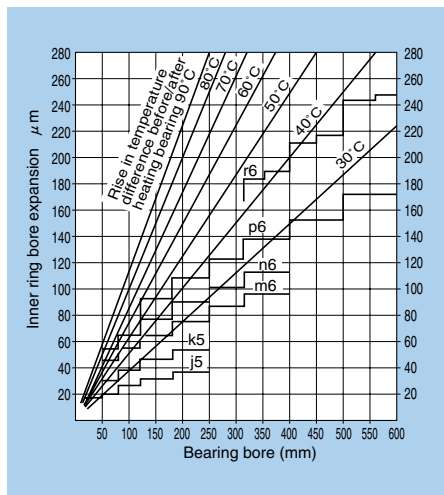

Fig. 16.3 Heating Temperature Required for Heat Fit of Inner Ring

inner ring is large, the bearing is generally heated to make the inner ring expand and can easily be inserted on the shaft. The amount of expansion according to temperature difference of the bearing bore is shown in **Fig. 16.3**.

Dipping in clean heated oil is the most common method of heating the bearing (this cannot be done with grease sealed bearings). You must also be careful not to heat the bearing in excess of 120°C. In addition to this there is heating in air in a thermostatic chamber, and inductance heaters are used for inner ring separation (required demagnetization) such as cylindrical rollers. After inserting the heated bearing on the shaft, the inner ring must be pressed against the shaft shoulder until the bearing cools in order to prevent clearance from developing.

(2) Mounting tapered bore bearings

A tapered shaft or adapter/withdrawal sleeve is used for small bearings with tapered bore. The bearings are driven into place with a locknut. (See **Fig. 16.4**)

Large bearings require a lot of driving force,

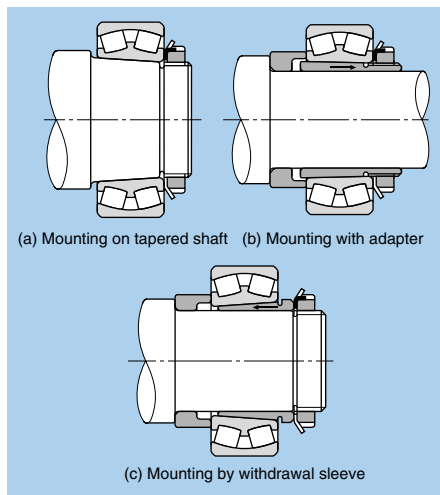

Fig. 16.4 Mounting by Locknut

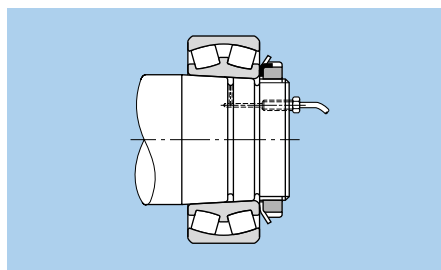

Fig. 16.5 Mounting by Oil Injection

and are mounted by hydraulic pressure. **Fig. 16.5** shows the bearing directly mounted on a tapered shaft. With this method, high-pressure oil is sent to the fit surface (oil injection) in order to reduce friction of the fitting surface and tightening torque of the nut. In addition to this, bearings can be mounted by a hydraulic nut or sleeve using hydraulic pressure. In the case of bearings mounted in this fashion, interference is increased and radial internal clearance is decreased by driving the tapered surface in the axial direction. You can estimate interference by measuring the amount the clearance decreases. To measure

radial internal clearance of self-aligning roller bearings, let the roller settle into their correct positions and insert a thickness gauge in between the rollers and outer ring where there is no load (**Fig. 16.6**). At this time, it is important to measure with the rollers still. You can also obtain the proper interference by measuring the amount of drive in the axial direction instead of the amount of radial internal clearance reduction.

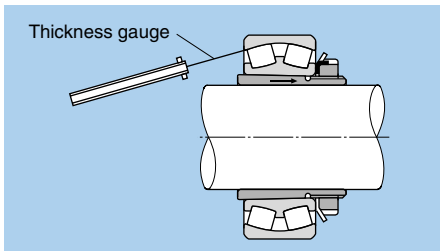

Fig. 16.6 Measuring Internal Clearance of Self-Aligning Roller Bearings

(3) Mounting outer rings

If the outer ring is interference-fit into the housing and the interference is large, depending upon the dimensions and shape of the housing, the housing can be heated to accommodate the outer ring, but cold fitting is generally used. With this method, the outer ring is shrunk using a coolant such as dry ice. With cold fitting, however, moisture in the atmosphere tends to condense on the bearing surface, thus necessitating suitable measures for preventing rust and frostbite.

16.2 Post-Installation Running Test

After mounting, the bearings must be checked to make sure they are properly installed. First, turn the shaft or housing with your hand to make sure there is no looseness, the torque isn't too great, or anything else out of the ordinary. If you don't notice anything unusual, run the equipment at low speed without a load. Gradually increase speed and load while checking rotation. If you notice any unusual noise, vibration or temperature increase, stop operation and check out the

problem. If necessary, remove and inspect the bearing. You can check the sound volume and the tone of the turning bearing by placing a stethoscope on the housing (see **Table 11.2**).

If there is a lot of vibration, it is possible to infer the source of the problem by measuring amplitude and frequency. Bearing temperature rises along with rotation time, and then stabilizes after a certain period of time elapses. If temperature rises sharply and does not stabilize no matter how much time elapses, you must stop operation and investigate the cause of the problem.

Possible causes include too much lubricant, too much seal interference, insufficient clearance, and too much pressure. It is best to measure bearing temperature by touching the measurement probe to the outer ring, but temperature is sometimes measured from the housing surface, or if there is no problem with doing so, by feeling the housing with the hand.

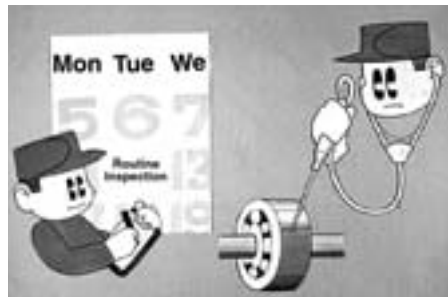

16.3 Bearing Removal

Bearings are removed for routine inspection and parts replacement. The shaft and housing are usually always reused, and in many cases the bearing itself can be reused. It is therefore important to be careful not to damage the bearing when removing. In order to do so, a structural design that facilitates removal and the use of proper tools are required. When removing a bearing ring mounted with interference, withdrawal load must be placed on that ring only. Never attempt to remove a bearing ring via the rolling elements.

(1) Cylindrical bore bearing removal

As shown in **Figs. 16.7** and **16.8**, a press or puller are often used to remove small bearings. Design must also take removal into consideration as shown in **Figs. 16.9 - 16.11**. Removal of large interference-fit bearings used for an extended period of time require a

large load. Such bearings should be designed for removal by hydraulic means such as shown in **Fig. 16.12**. Inductance heaters can be used to remove cylindrical roller bearings with separable inner and outer rings.

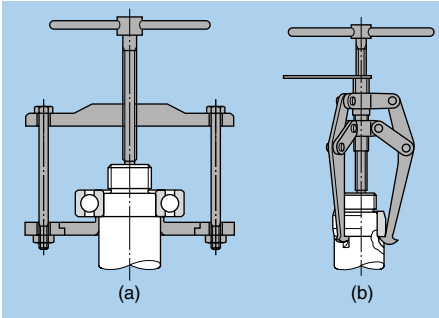

Fig. 16.7 Removal by Puller

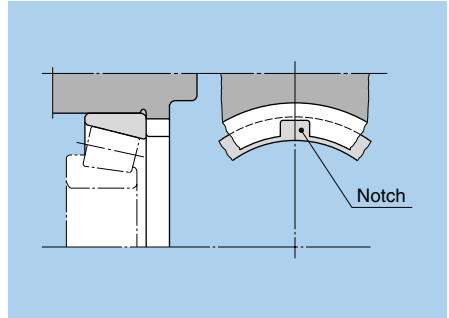

Fig. 16.10 Notch for Outer Ring Removal

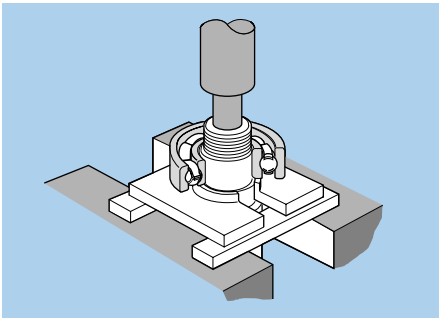

Fig. 16.8 Removal by Press

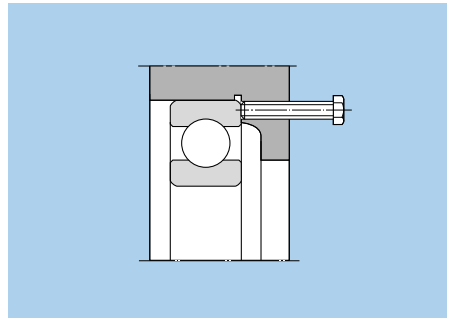

Fig. 16.11 Bolt for Outer Ring Removal

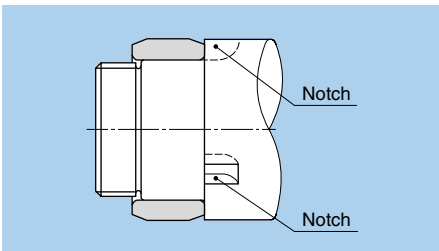

Fig. 16.9 Notch for Removal

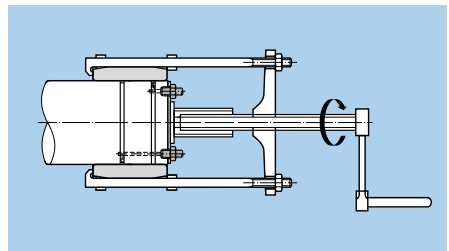

Fig. 16.12 Removal by Hydraulic Means

(2) Tapered bore bearing removal

Small bearings mounted using an adapter sleeve are removed by loosening the fastening nut, placing a metal block on the inner ring as shown in **Fig. 16.13**, and tapping with a hammer.

The task of removing large bearings mounted on a tapered shaft using an adapter sleeve or withdrawal sleeve is facilitated by using a hydraulic means of removal. (See **Figs. 16.14** and **16.15**)

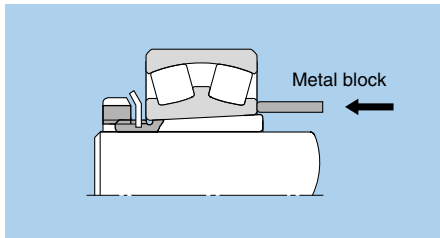

Fig. 16.13 Removal of Bearing W/Adapter Sleeve

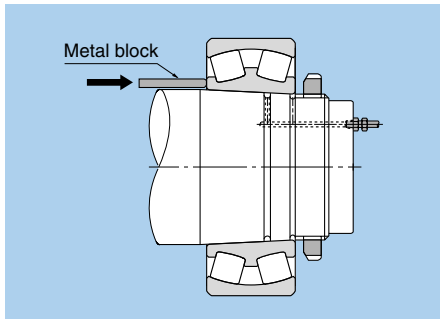
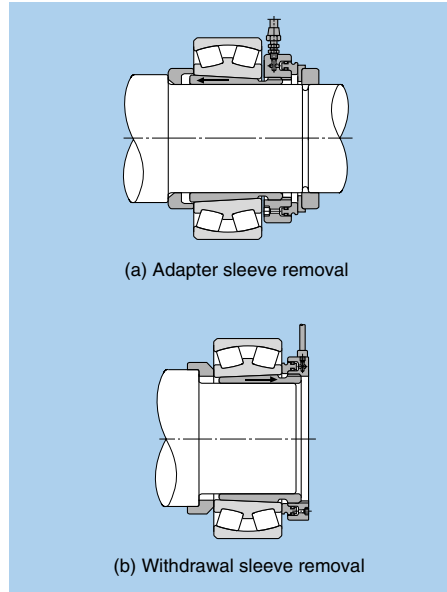

Fig. 16.14 Removal of Bearing by Hydraulic Means



(a) Adapter sleeve removal

(b) Withdrawal sleeve removal

Fig. 16.15 Removal by Hydraulic Nut

16.4 Press Fit and Pullout Force

The force required to press fit or remove a bearing on/from a shaft or in/from a housing is calculated by the following equations.

For shaft and inner ring:

$$K_d = \mu \cdot P \cdot \pi \cdot d \cdot B \dots\dots\dots (16.1)$$

For housing and outer ring:

$$K_D = \mu \cdot P \cdot \pi \cdot D \cdot B \dots\dots\dots (16.2)$$

Where:

- K_d : Inner ring press fit or withdrawal force
N {kgf}
- K_D : Outer ring press fit or withdrawal force
N {kgf}
- P : Fit surface pressure
MPa {kgf/mm²}

$$\text{Inner ring } P = \frac{E}{2} \frac{\Delta_{\text{def}}}{d} \frac{(1-k^2)(1-k_0^2)}{1-k^2 k_0^2}$$

$$\text{Outer ring } P = \frac{E}{2} \frac{\Delta D_{\text{eff}}}{D} \frac{(1-h^2)(1-h_0^2)}{1-h^2 h_0^2}$$

Where:

$$k = \frac{d}{d_i} \quad k_0 = \frac{d_0}{d} \quad h = \frac{D_e}{D} \quad h_0 = \frac{D}{D_0}$$

- d : Inner ring bore (shaft diameter) mm
- d_i : Inner ring raceway diameter mm
- d_0 : Hollow shaft bore
($d_0 = 0$ for solid shaft) mm
- Δ_{def} : Inner ring effective interference mm
- D : Outer ring outer diameter
(housing inner diameter) mm
- D_e : Outer ring raceway diameter mm
- D_0 : Housing outer diameter mm
- ΔD_{eff} : Outer ring effective interference mm
- E : Modulus of longitudinal elasticity
2.07 × 10⁶MPa
{21 200kgf/mm²}
- μ : Friction factor (see **Table 16.1**)
- B : Width of inner ring or outer ring mm

Table 16.1 Friction Factor for Press Fitting and Withdrawal

Applications	μ
When inner (outer) ring is press-fitted on/into cylindrical shaft (hole)	0.12
When inner (outer) ring is withdrawn from cylindrical shaft (hole)	0.18
When inner ring is press-fitted onto tapered shaft or sleeve	0.17
When inner ring is withdrawn from tapered shaft	0.14
When sleeve is press-fitted onto shaft/bearing	0.30
When sleeve is withdrawn from shaft/bearing	0.33



17. Bearing damage and corrective measures

As long as they are handled properly, bearings can usually be used the entire extent of their rolling fatigue life. Premature damage is usually the result of improper bearing selection, handling, lubrication or sealing device. Because there are so many factors involved, it is almost impossible to infer the cause from the appearance of the damage. It is however

important to know the type of machine used, the location and conditions of usage and construction surrounding the bearing, etc., and infer the cause from the situation when the damage occurred and the type of damage to prevent reoccurrence. Primary causes and corrective measures for bearing damage are given in **Table 17.1 (a), (b), (c), (d) and (e)**.

Table 17.1 (a) Bearing damage and corrective measures

Description	Causes	Corrective measures
<p>● Flaking</p>  <p>Flakes form on the surfaces of the raceway and roller elements. When the flakes fall off, the surface becomes rough and uneven.</p>	<ul style="list-style-type: none"> ● Excessive loads, fatigue life, improper handling ● Improper mounting ● Insufficient precision of shaft or housing ● Insufficient clearance ● Contamination ● Rust ● Improper lubrications ● Softening due to abnormal temperature rise 	<ul style="list-style-type: none"> ● Select another type of bearing. ● Reconsider internal clearance. ● Improve precision of shaft or housing. ● Improve operating conditions. ● Improve method of assembly and handling. ● Check bearing periphery. ● Reconsider lubricant and lubrication method.
<p>● Seizure</p>  <p>Bearing heats up, becomes discolored and eventually seizes up.</p>	<ul style="list-style-type: none"> ● Insufficient clearance (including clearances made smaller by local deformation) ● Insufficient lubrication, improper lubricant ● Excessive load (excessive preload) ● Roller skew ● Softening due to abnormal temperature rise 	<ul style="list-style-type: none"> ● Reconsider lubricant type and quantity. ● Reconsider internal clearance (enlarge internal clearance). ● Prevent misalignment. ● Reconsider operating conditions. ● Improve method of assembly and handling.

Table 17.1 (b) Bearing damage and corrective measures

Description	Causes	Corrective measures
<p>●Cracking and notching</p>  <p>Localized flaking and cracking.</p>	<ul style="list-style-type: none"> ● Excessive shock load ● Improper handling (use of steel hammer and impact of large foreign particles) ● Surface deformation due to improper lubrication ● Excessive interference ● Large flaking ● Friction cracks ● Insufficient precision of counterpart (fillet radius too large) 	<ul style="list-style-type: none"> ● Reconsider lubricant (prevent friction cracks). ● Reconsider proper interference and material. ● Reconsider operating conditions. ● Improve method of assembly and handling.
<p>●Cage damage</p>  <p>Rivets become loose or break off. Cage becomes damaged.</p>	<ul style="list-style-type: none"> ● Excessive moment load ● High-speed rotation or excessive rotation fluctuation ● Improper lubrication ● Impact of foreign matter ● Excessive vibration ● Improper mounting (misalignment) 	<ul style="list-style-type: none"> ● Reconsider lubricant and lubrication method. ● Select a different type of cage. ● Investigate rigidity of shaft and housing. ● Reconsider operating conditions. ● Improve method of assembly and handling.
<p>●Meandering wear patterns</p>  <p>Meandering or irregular wear of raceway surface by rolling elements</p>	<ul style="list-style-type: none"> ● Insufficient precision of shaft or housing. ● Improper mounting ● Insufficient rigidity of shaft and housing ● Shaft sling due to excessive internal clearance 	<ul style="list-style-type: none"> ● Re-check internal clearance. ● Reconsider machining precision of shaft or housing. ● Reconsider rigidity of shaft and housing.

Table 17.1(c) Bearing damage and corrective measures

Description	Causes	Corrective measures
<p>● Smearing and scuffing</p>  <p>Surface becomes rough with small deposits. "Scuffing" generally refers to roughness of the bearing ring ribs and roller end faces.</p>	<ul style="list-style-type: none"> ● Improper lubrication ● Invasion of foreign matter ● Roller skew due to bearing misalignment ● No oil on rib surface due to excessive axial load ● Excessive surface roughness ● Excessive sliding of rolling elements 	<ul style="list-style-type: none"> ● Reconsider lubricant and lubrication method. ● Improve sealing performance. ● Reconsider preload. ● Reconsider operating conditions. ● Improve method of assembly and handling.
<p>● Rust and corrosion</p>  <p>Surface becomes partially or fully rusted. Rust may also develop on rolling element pitch lines.</p>	<ul style="list-style-type: none"> ● Improper storage ● Improper packaging ● Insufficient rust preventative ● Invasion of moisture, acid, etc. ● Handling with bare hands 	<ul style="list-style-type: none"> ● Take measure to prevent rusting while in storage. ● Inspect lubricant on regular basis. ● Improve sealing performance. ● Improve method of assembly and handling.
<p>● Fretting</p>  <p>There are two types of fretting: the type where rust-colored wear powder forms on fitting surfaces, and the type where brinelling indentation forms on the raceway along the pitch of the rolling elements.</p>	<ul style="list-style-type: none"> ● Insufficient interference ● Small bearing oscillation angle ● Insufficient lubrication (unlubricated) ● Fluctuating load ● Vibration during transport or when not operating 	<ul style="list-style-type: none"> ● Select a different type of bearing. ● Reconsider lubricant and lubrication method. ● Reconsider interference and apply lubricant to fitting surface. ● Package inner and outer rings separately for transport.

Table 17.1(d) Bearing damage and corrective measures

Description	Causes	Corrective measures
<p>●Wear</p>  <p>The surface becomes worn, resulting in dimension change. Wear is often accompanied by roughness and damage.</p>	<ul style="list-style-type: none"> ● Foreign matter in the lubricant ● Insufficient lubrication ● Roller skew 	<ul style="list-style-type: none"> ● Reconsider lubricant and lubrication method. ● Improve sealing performance. ● Prevent misalignment.
<p>●Electrolytic corrosion</p>  <p>Pits form on raceway and develop into ripples.</p>	<ul style="list-style-type: none"> ● Electric current flowing through raceway 	<ul style="list-style-type: none"> ● Create a bypass for current. ● Insulate the bearing.
<p>●Dents and scratches</p>  <p>Impact of solid foreign matter. Scoring during assembly, gouges in surface due to impact.</p>	<ul style="list-style-type: none"> ● Solid foreign matter ● Dents caused by flakes ● Impact or dropping due to improper handling ● Misalignment when assembling 	<ul style="list-style-type: none"> ● Improve method of assembly and handling. ● Improve sealing performance (to prevent foreign matter from getting inside). ● Check bearing periphery (when caused by metal shavings).

Table 17.1(e) Bearing damage and corrective measures

Description	Causes	Corrective measures
<p>● Creep</p>  <p>Surface becomes mirror finished due to slipping of the inner and outer surfaces. Sometimes accompanied by discoloration or scuffing.</p>	<ul style="list-style-type: none"> ● Insufficient interference of fitted parts ● Insufficient sleeve tightening ● Abnormal temperature rise ● Excessive load 	<ul style="list-style-type: none"> ● Reconsider interference. ● Reconsider operating conditions. ● Reconsider machining precision of shaft and housing.
<p>● Surface matting</p>  <p>Surface luster disappears, and surface becomes matted and rough. Surface becomes covered with tiny dents.</p>	<ul style="list-style-type: none"> ● Foreign matter ● Improper lubrication 	<ul style="list-style-type: none"> ● Reconsider lubricant and lubrication method. ● Improve sealing devices ● Clean lubricating oil (with filter)
<p>● Peeling</p>  <p>Patches of minute peeling (approx. 10 μm). Accompanied by innumerable cracks that have not yet peeled.</p> <p>(Tends to form on roller bearings.)</p>	<ul style="list-style-type: none"> ● Foreign matter ● Improper lubrication 	<ul style="list-style-type: none"> ● Reconsider lubricant and lubrication method. ● Improve sealing performance (prevent foreign matter from getting in). ● Perform warm-up operation prior to work.

One-Point Advice

Bearing Tips

● **Transition of NTN Technology (Introduction of "Technical Review")**

NTN technology has developed along with advancements in various industries based on rolling bearings. There is practically no industry that can exist without the use of bearings, beginning with the steel industry in the postwar reconstruction period, and including railway cars, automobiles, aircraft, high-speed communications and environment-related industries. Some of these are covered in NTN TECHNICAL REVIEW (formerly "Bearing Engineer").



Inaugural Issue
October, 1950



No. 10
December, 1954



No. 20
December, 1959
High-speed bearings



No. 29
December, 1964



No. 42
May, 1972
Aircraft bearings



No. 50
October, 1984



No. 60
January, 1992
Precision bearings



No. 61
June, 1992
Automobile bearings/parts



No. 62
March, 1993
Industrial machine bearings



No. 63
June, 1994
New materials / surface improvement

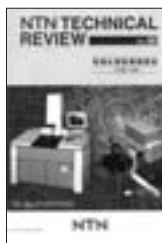

No. 64
June, 1995
Precision devices and products



No. 65
October, 1996
Automobile products



No. 66
August, 1997
Constant velocity joints

Reference material

Abbreviation	Standards
JIS	Japanese Industrial Standards
BAS	The Japan Bearing Industrial Association Standards
ISO	International Organization for Standardization
DIN	Deutsche Industrie Normen
ANSI	American National Standards
ABMA	The American Bearing Manufacturers Association
BS	British Standards
MIL	Military Specifications and Standards
SAE	Society of Automotive Engineers
ASTM	American Society for Testing and Materials
ASME	American Society of Mechanical Engineers
JGMA	Japan Gear Manufactures Association

NAME

ADDRESS

PHONE

OFFICE

PHONE
