

# Bearing Life

<b>Nominal life</b>	<b>56</b>
■ Types of failure	56
■ Basic formula	58
■ Basic dynamic load of the bearing	59
■ Equivalent radial dynamic load P	60
■ Definition	61
<i>Axial load factor Y</i>	61
■ Definition of the static capacity	61
■ Equivalent static load	63
■ Variable loads or speeds	64
■ Design calculation of a shaft mounted on 2 angular contact bearings	65
<i>Radial balance of the shaft</i>	65
<i>Axial balance of the shaft</i>	66
■ Required service life	67
<b>Corrected nominal life</b>	<b>68</b>
■ Bearing reliability	74
<i>Definition of the <math>a_1</math> factor</i>	74
<i>Reliability for a chosen operating time</i>	75
<i>Specifying <math>a_1</math> and reliability for a chosen life duration</i>	75
<i>Duration and reliability of a set of bearings</i>	76
■ Influence of lubrication	77
<i>Separating power of the lubricant</i>	77
<i>Elasto-hydrodynamic theory (EHD)</i>	77
<i>Determination of the minimum required viscosity</i>	78
<b>Parameters influencing bearing life</b>	<b>80</b>
■ Influence of the temperature	80
<i>Normal operating temperatures</i>	80
■ Influence of the operating clearance	81
<i>Radial-contact bearing under radial load</i>	81
<i>Angular-contact bearing under radial and axial load</i>	81
■ Influence of an excessive load	82
■ Influence of form and position defects	82
<i>Shape defects</i>	82
<i>Misalignment</i>	82
<b>Friction and bearing speed</b>	<b>84</b>
■ Friction	84
■ Bearing speed	85
<i>Theory of the Standard ISO 15312</i>	85
<i>SNR theory</i>	87

## Nominal life

### Types of failure

The principal measure of the performance of a bearing is its service life, that is to say the number of revolutions it can make before the first sign of spalling appears.

Apart from "seizure" type failure which can be the consequence of inadequate lubrication, the main types of failure can be classified in 3 categories:

- deep spalling initiated at depth (DSID)
- surface spalling initiated at the surface (SSIS)
- deep spalling initiated at the surface (DSIS)

#### ■ Deep spalling initiated at depth (DSID)

This is the "conventional" failure of a bearing operating under normal conditions, when the lubrication is effective.

The principle of bearing construction leads to contact between the rolling elements and rings that are the location of very high specific loads.

The Hertz stresses (figure opposite) at this level have the following consequences:

- compression stresses, maximal at the surface with values that can reach 3,500 N/mm<sup>2</sup>
- shear stresses, maximal in sub-surface with values that can reach 1,000 N/mm<sup>2</sup>

If the level of the load is sufficient and applied under clean lubricated environmental conditions (see page 77), type EHD, the alternating stresses to which the raceways are subjected sooner or later lead to a crack within the material. This crack starts from inclusions in the sublayer in the area where the Hertz stresses are maximal.

The crack appears in the matrix in the vicinity of an inclusion.

The crack propagates towards the surface and causes the detachment of a fragment of steel, the first sign of failure by spalling.

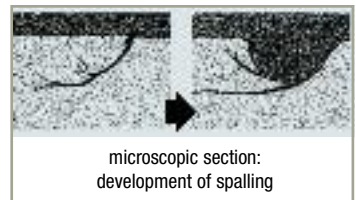
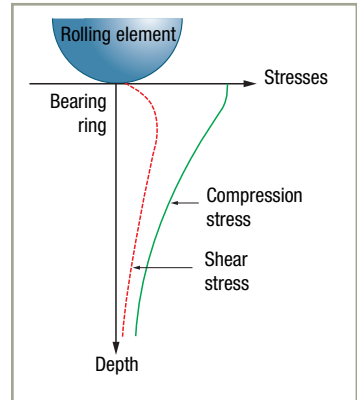

### ■ Superficial spalling initiated at the surface (SSIS)

In the presence of small (from a few  $\mu\text{m}$  to  $50\ \mu\text{m}$ ) hard (harder than the bearing elements, i.e. 700 HV10) particles, one finds wear of the bearing elements due to metal-to-metal contact, resulting from uneven lubrication at that sensitive point.

This leads to the damage of the active surfaces through a very superficial form of spalling also called "peeling", from 10 to 20 microns in depth and affecting a large area of the raceways. This is a slow failure process. It is of the same type as that caused by an insufficient oil film resulting from excessively low viscosity..

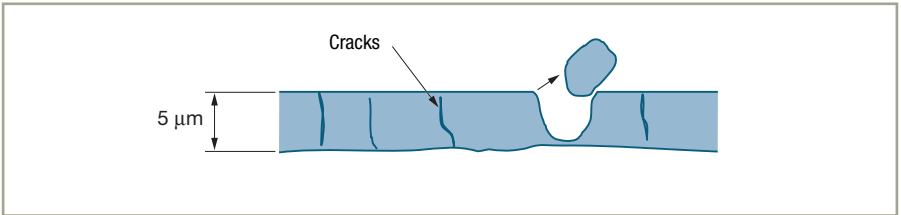

### ■ Deep spalling initiated at the surface (DSIS)

When the contamination consists of coarser particles (from  $20\ \mu\text{m}$  to  $300\ \mu\text{m}$ , and larger), the flow of particles between the rolling element and the ring leads to local plastic deformation of the raceway. The effect of this contamination differs according to its hardness.

If the particle is sufficiently ductile, it can undergo plastic deformation without breaking and form a pancake. On the other hand, if it is brittle, it shatters under contact while causing plastic deformation of the bearing elements.

These new fragments then behave in accordance with the 2<sup>nd</sup> SSIS mechanism described above. There is then competition between the damage caused by the local plastic deformation due to the indentation and that resulting from the abrasive wear caused by the particle fragments.

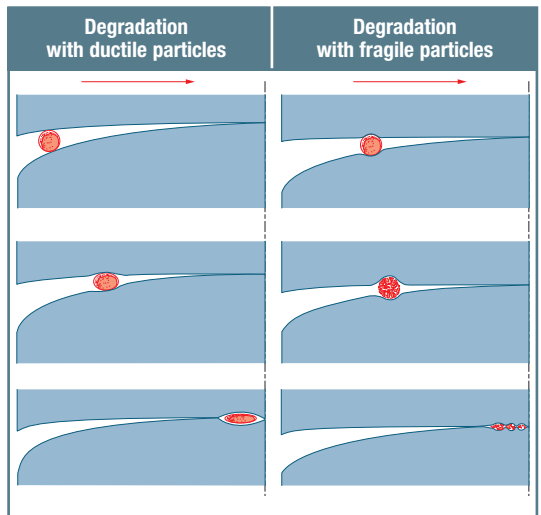

## Nominal life *(continued)*

In the case of an indentation, the spalling does not initiate directly on the edge of the indentation. One finds a protected zone in the plastically deformed volume and the crack starts beyond this zone and leads to deep spalling initiated at the surface (DSIS).

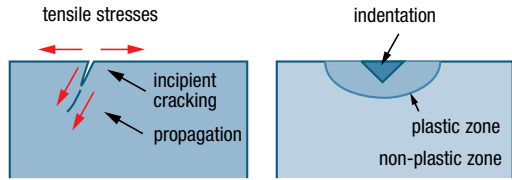

Considering the diversity of the contaminating particles found in the oil of a mechanical component and its evolution when new and after running in, and also considering the nature of the rolling elements (rollers or balls), which are affected to a greater or lesser extent by the phenomenon of slipping, the failure is often a combination of the SSIS and DSIS types.

## Basic formula

The service life of a bearing can be calculated more or less precisely, depending on the defined operating conditions.

The simplest method recommended by standard ISO 281, enables one to calculate the service life reached by 90% of bearings operating under a dynamic load.

➔ The simplified method of calculation below is based on fatigue being the cause of failure (spalling type DSIS)

■ To determine the simplified service life per standard ISO 281, one calculates:

▶ The equivalent dynamic radial load  $P$

$$P = X \cdot F_r + Y \cdot F_a$$

▶ The nominal life  $L_{10}$

$$L_{10} = (C / P)^n 10^6 \text{ in revolutions}$$

or

$$L_{10} = (C / P)^n / 60N \text{ in hours}$$

$n$  : 3 for ball bearings or ball thrust bearings

$n$  : 10/3 for roller bearings or roller thrust bearings

One sees that: if  $P = C$ ,  $L_{10} = 1$  million revolutions

This is therefore the load under which the bearings have a nominal service life of one million revolutions.

It is also called the dynamic load capacity.

## Basic dynamic load of the bearing

---

■ The basic dynamic load of the bearing defined in the chapter corresponding to each family, is calculated in accordance with standard ISO 281 using the formulae given below:

Ball bearings (for ball diameter < 25.4 mm)

$$C = f_c(i \cdot \cos\alpha)^{0.7} Z^{2/3} \cdot D_w^{1.8}$$

Roller bearings

$$C = f_c(i \cdot l \cdot \cos\alpha)^{7/9} Z^{3/4} \cdot D_w^{29/27}$$

Ball thrust bearings (for ball diameter < 25.4 and  $\alpha = 90^\circ$ )

$$C = f_c \cdot Z^{2/3} \cdot D_w^{1.8}$$

### ■ Remark

► It can be seen that the exponent that affects the diameter  $D_w$  of the rolling element is greater than that concerning their number  $Z$ . Consequently one cannot compare the capacity of two bearings with the same part number but a different internal definition simply taking into account the number of rolling elements. The other parameters in the calculation formula must also be taken into account.

► Load capacity of double bearings

As regards the bearings with two rows of rolling elements ( $i = 2$ ) or assemblies comprising two identical bearings, the capacity ( $C_e$ ) of the assembly is that of one row ( $C$ ) multiplied by:

for ball assemblies

$$2^{0.7} = 1.625$$

for roller assemblies

$$2^{7/9} = 1.715$$

It can thus be seen that by doubling the number of bearings increases the load capacity by 62.5 or 71.5% depending on the type used. The load capacity and therefore the service life are not doubled.









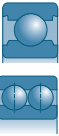

## Nominal life *(continued)*

### Equivalent dynamic radial load P

$$P = X \cdot F_r + Y \cdot F_a$$

X and Y = load factors defined in the table below

$F_a$  and  $F_r$  = axial and radial forces applied to the bearing

Type	Cross-section	Series	Contact angle	$F_a/C_0$		$F_a / F_r \leq e$		$F_a / F_r > e$	
						X	Y	X	Y
Single- or double-row radial contact ball bearings		60-62-63-64 160-618-619 622-623 42-43		0.014	0.19	1	0	0.56	2.30
				0.028	0.22				1.99
				0.056	0.26				1.71
				0.084	0.28				1.55
				0.110	0.30				1.45
				0.170	0.34				1.31
				0.280	0.38				1.15
				0.420	0.42				1.04
0.560	0.44	1.00							
Single-row radial contact ball bearings, with higher than normal residual clearance		60-62-63-64 160-618-619 622-623		0.014	0.29	1	0	0.46	1.88
				0.029	0.32				1.71
				0.057	0.36				1.52
				0.086	0.38				1.41
				0.110	0.40				1.34
				0.170	0.44				1.23
				0.280	0.49				1.10
				0.430	0.52				1.01
0.570	0.54	1.00							
Single-row angular contact ball bearings		72-73	40°		1.14	1	0	0.35	0.57
		QJ2-QJ3	30°		0.80	1	0	0.39	0.76
			35°		0.95	1	0	0.37	0.66
Double-row angular contact ball bearings		32-33	35°		0.95	1	0.66	0.60	1.07
		32..A-33..A	25°		0.68	1	0.92	0.67	1.41
		52-53	32°		0.86	1	0.73	0.62	1.17
		32..B-33..B							
Double-row self-aligning ball bearings		12-13			see list of Standard bearings	1	see list of Standard bearings	0.65	see list of Standard bearings
		22-23							
		112-113							
Tapered roller bearings		302-303-313			see list of Standard bearings	1	0	0.40	see list of Standard bearings
		320-322-322..B							
		323-323..B 330-331-332							
Double-row spherical roller bearings		213-222-223			see list of Standard bearings	1	see list of Standard bearings	0.67	see list of Standard bearings
		230-231-232							
		240-241							
Cylindrical roller bearings		N..2-N..3-N..4			-	1	-	1.00	-
		N..10							
		N..22-N..23							
Single- or double-direction ball thrust bearing		511-512-513			-	-	-	-	1.00
		514							
Spherical roller thrust bearing		293-294			1.82	-	-	1.20	1.00

## Definition

### → Axial load factor $Y$

The way in which the axial load factor  $Y$ , which depends on the bearing contact angle, is calculated differs according to the type of bearing:

#### ■ Radial ball bearings

The contact angle is zero under a purely radial load. Under an axial load, the local deformations from ball-to-raceway contact cause relative axial displacement of the two rings. The contact angle ( $\alpha$ ) therefore increases as a function of the applied axial load. The ratio  $F_a/C_0$  is used to determine the value of  $Y$  and therefore take into account the modification of contact angle due to the axial force.

#### ■ Angular contact bearings

The contact angle is determined by construction and varies little as a function of the combined loads. The axial load factor  $Y$  for a given contact angle is therefore considered in an initial approximation as being constant. The angular contact ball bearings, with an identical contact angle for all the bearings, are calculated with the same load factor  $Y$ . With tapered roller bearings,  $Y$  varies according to the series and dimension.

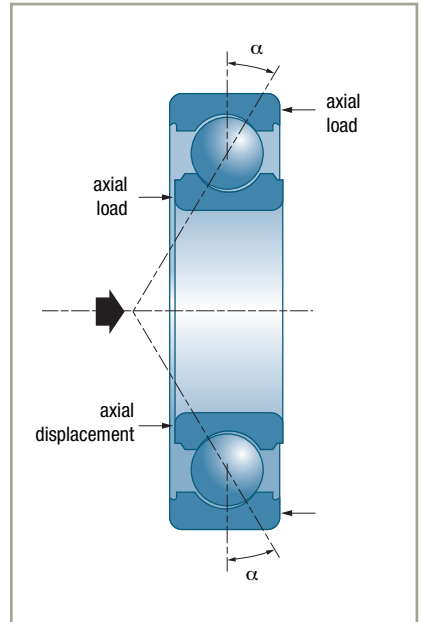

## Definition of the static capacity

■ The size of the bearing must be chosen from the static load when:

- the bearing is stationary or making slight oscillating movements and withstanding continuous or intermittent loads,
- the bearing is subjected to shocks during normal rotation.

## Nominal life *(continued)*

A static load applied on a bearing can, because of the stresses in the contact between the rolling elements and the raceways, lead to permanent local deformation that is detrimental to the proper operation of the bearing when rotating.

A maximum permissible radial load is therefore defined such as the one inducing stress in the stationary bearing that can be tolerated in the majority of applications without reducing service life and rotation.

The value  $C_0$  of this maximum permissible load is called the basic static capacity of the bearing (or static capacity).

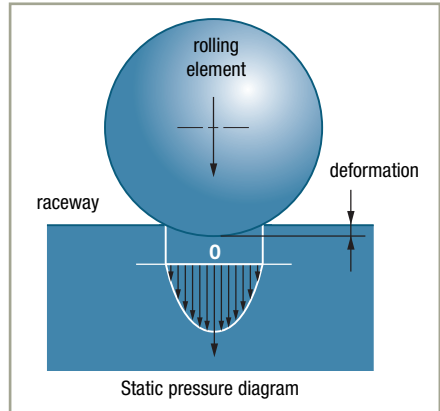

### ■ Basic static capacity of a bearing $C_0$

This has been defined in ISO 76 standard as the radial load (axial in the case of thrust bearings) that creates at the most heavily loaded point of contact (between rolling element and raceway) a Hertz pressure of:

- 4200 MPa for ball bearings and ball thrust bearings (all types except self-aligning ball bearings)
- 4600 MPa for self-aligning ball bearings
- 4000 MPa for roller bearings and roller thrust bearings (all types)

$$1\text{MPa} = 1\text{Mégapascal} = 1 \text{ N/mm}^2$$

### ■ Equivalent static load $P_0$

In the case where the bearing is subjected to combined static loads such as  $F_r$  a radial component, and  $F_a$  the axial component, one calculates an equivalent static load to compare it to the static capacity of the bearing.

The static load capacity of the bearing is to be considered more as a size magnitude than a precise limit not to be exceeded.

### The safety factor

$$f_s = C_0 / P_0$$

$C_0$  is the basic static capacity defined in the tables of bearing characteristics.

Usual minimum values for the safety factor  $f_s$ :

- 1.5 to 3 for severe requirements
  - 1.0 to 1.5 for normal conditions
  - 0.5 to 1 for operation without noise or precision requirements
- If a rotating bearing with quiet operation requirements is needed, the safety factor  $f_s$  must be high.



## Equivalent static load







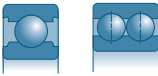

The equivalent static load is the higher of the two values if

$$P_0 = F_r$$

$$P_0 = X_0 \cdot F_r + Y_0 \cdot F_a$$

if  $F_r$  and  $F_a$  are the applied static forces.

■ The factors  $X_0$  and  $Y_0$  are defined in the table below:

Type	Cross-section	Series	Contact angle	$X_0$	$Y_0$
Single- or double-row radial contact ball bearings		60-62-63-64 160-618-619-622 623 42-43		0.6	0.5
Single-row angular contact ball bearings		72 - 73	40°	0.5	0.26
		QJ2 - QJ3	35°	0.5	0.29
Double-row angular contact ball bearing		32 - 33	35°	1.0	0.58
		32..A - 33..A	25°	1.0	0.76
		52 - 53 32B - 33B	32°	1.0	0.63
Double-row self-aligning ball bearings		12 - 13 22 - 23 112 - 113		0.5	See list of Standard Bearings
Tapered roller bearings		302 - 303 - 313 320 - 322 - 322..B 323 - 323..B - 330 331 - 332		1.0	
Double-row spherical roller bearings		213 - 222 - 223 230 - 231 - 232 240 - 241		1.0	
Cylindrical roller bearings		N..2 - N..3 - N..4 N..10 N..22 - N..23		1.0	
Single-direction ball thrust bearings		511 - 512 - 513 514		0	1
Spherical roller thrust bearings		293 - 294		2.7 si $F_r / F_a < 0.55$	1

## Nominal life *(continued)*

### Variable loads or speeds

■ When a bearing functions under variable loads or speeds, an equivalent load and speed are determined in order to calculate the service life.

#### ▸ Constant load and variable speed of rotation

Equivalent speed  $N_e = t_1 \cdot N_1 + t_2 \cdot N_2 + \dots + t_z \cdot N_z$  With  $\sum_{i=1}^z t_i = 1$

#### ▸ Variable load and constant speed of rotation

Equivalent load  $P_e = (t_1 \cdot P_1^n + t_2 \cdot P_2^n + \dots + t_z \cdot P_z^n)^{1/n}$  With  $\sum_{i=1}^z t_i = 1$

#### ▸ Cyclic load and constant speed of rotation

Equivalent load

##### • Sinusoidal load

$$P_e = 0.32 P_{min} + 0.68 P_{max}$$

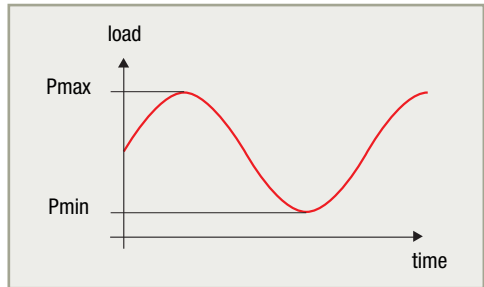

##### • Linear load

$$P_e = 1 / 3 (P_{min} + 2 P_{max})$$

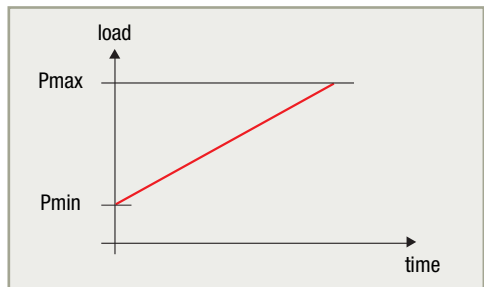

■ If the speed of rotation and the load are variable, the service life is calculated for each level of use, then the duration is weighted for the cycle as a whole.

► Variable load and speed of rotation

Weighted duration  $L = (t_1 / L_1 + t_2 / L_2 + \dots + t_z / L_z)^{-1}$  with  $\sum_{i=1}^z t_i = 1$

with:

- $t_i$  Duration of use
- $N_i$  Speed of rotation for duration of use  $t_i$
- $P_i$  Load for duration of use  $t_i$
- $L_i$  Service life for duration of use  $t_i$
- $n$  3 for ball bearings and ball thrust bearings
- $n$  10/3 for roller bearings and roller thrust bearings

## Design calculation of a shaft mounted on 2 angular contact bearings

Shaft mounted on 2 simple non-preloaded bearings subjected to axial and radial loads.

→ Radial balance of the shaft

■ Calculation of the radial loads  $F_{r1}$  and  $F_{r2}$  applied on the bearing load application points by static radial balance of the shaft.

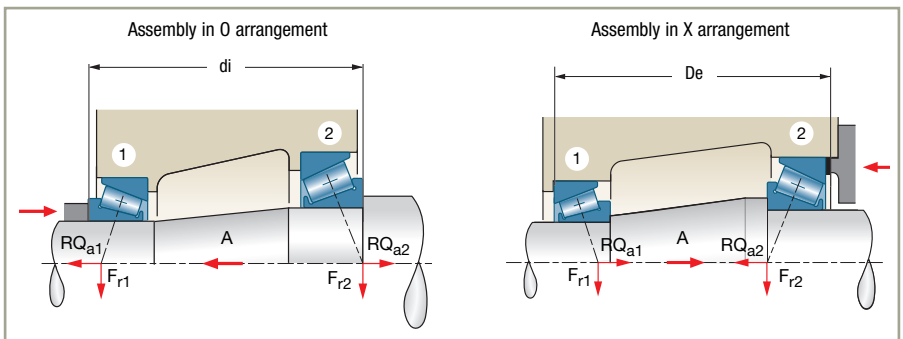

## Nominal life *(continued)*

### → Axial balance of the shaft

■ As the raceways of angular contact bearings are displaced, the radial loads  $F_{r1}$  and  $F_{r2}$  produce an axial reaction force called an induced axial force.

If bearing 1 is the bearing whose induced axial force is in the direction of the external axial force  $A$ , the shaft equilibrium is:

$$A + RQ_{a1} = RQ_{a2}$$

With  $RQ_{a1}$  and  $RQ_{a2}$ : axial loads applied to the bearings calculated in the table below:

#### ► Load case:

$$A + (F_{r1} / 2 Y_1) > (F_{r2} / 2 Y_2)$$

bearing 1 works with clearance

	Bearing 1	Bearing 2
Applied axial load	$RQ_{a1} = F_{r1} / 2 Y_1$	$RQ_{a2} = A + (F_{r1} / 2 Y_1)$
Axial load used in the calculation of the equivalent dynamic load	$F_{a1} = 0$	$F_{a2} = RQ_{a2}$

#### ► Load case:

$$A + (F_{r1} / 2 Y_1) < (F_{r2} / 2 Y_2)$$

bearing 2 works with clearance

	Bearing 1	Bearing 2
Applied axial load	$RQ_{a1} = (F_{r2} / 2 Y_2) - A$	$RQ_{a2} = F_{r2} / 2 Y_2$
Axial load used in the calculation of the equivalent dynamic load	$F_{a1} = RQ_{a1}$	$F_{a2} = 0$

# Required bearing life

■ The required bearing life is set by the manufacturer of the equipment in which the bearing is fitted.

For example, you will find below the orders of magnitude of these service life limits usually adopted for machines working in miscellaneous mechanical sectors:

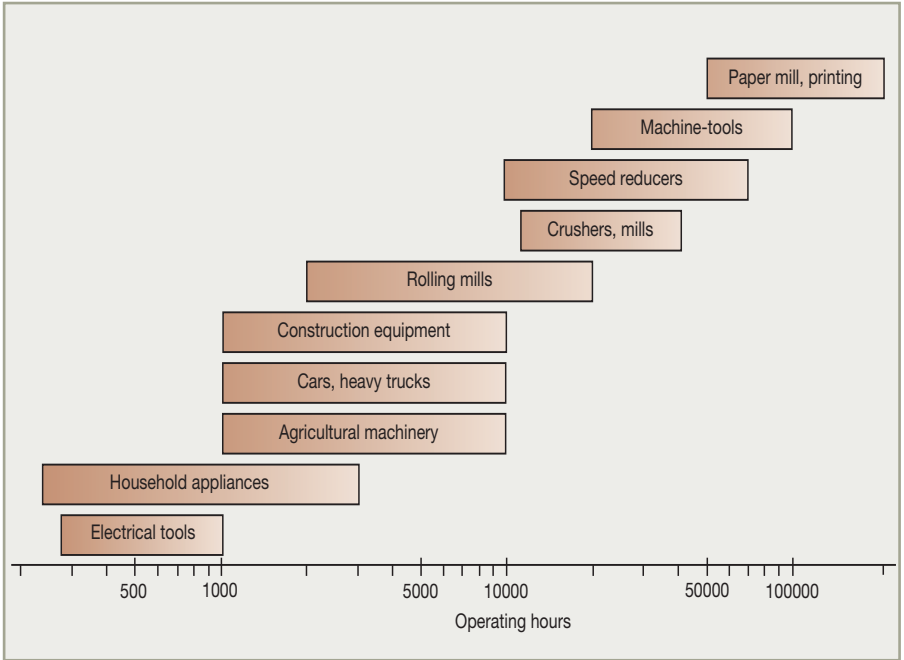

## Corrected nominal life

■ **Base nominal life,  $L_{10}$** , is often a satisfactory estimate of a bearing's performance capabilities. It refers to 90% reliability and conventional operating conditions. In certain applications, it may be necessary to compute service life for a different reliability level or for specific lubrication and contamination conditions.

With modern, high quality bearing steels, it is possible to obtain, under low loads and in favorable operating conditions, very long service life limits compared with  $L_{10}$ . A service life shorter than  $L_{10}$  may occur due to unfavorable operating conditions.

Below a given load  $C_U$ , a modern, high-quality bearing can reach infinite service life if lubrication, cleanliness and other operating conditions are favorable.

This load,  $C_U$  can be accurately determined according to the type of bearing and its internal geometry, the profile of the rolling elements and the races, and the fatigue limit of the race material. A sufficient approximation can be computed based on the bearing's static capacity.

■ **The international Standard ISO 281** introduces a service life correction factor,  $a_{ISO}$  which allows you to compute a corrected nominal service life as follows:

$$L_{nm} = a_1 a_{ISO} L_{10}$$

This factor provides an estimate of the influence of lubrication and contamination on bearing service life, also taking into account steel fatigue limit.

The evaluation method for  $a_{ISO}$  defined by ISO281, is rather difficult to apply for a non-specialist. Therefore, SNR has determined the best way to provide its clients with a simple  $a_{ISO}$  determination means, based on the assumption that the fatigue load,  $C_U$ , is directly linked with the bearing's static capacity and that the contamination factor is constant whatever the lubrication conditions and the mean diameter of the bearing.

The method proposed by SNR provides a quick, graphic evaluation of the  $a_{ISO}$  factor.

Our engineers are at your disposal to more accurately determine this factor, as required.

The 4 diagrams in the following pages allow  $a_{ISO}$  determination for ball bearings, roller bearings, ball thrust bearings and roller thrust bearings according to the method below:

## ■ $a_{ISO}$ determination method (standard ISO 281)

1. Define the lubricant viscosity at operating temperature from the diagram on page 78.  
Take the basic oil viscosity for the lubricated bearings.
2. Define the pollution level:
  - ▶ **High cleanliness**  
Oil filtered through an extremely fine mesh filter; usual conditions for life lubricated and sealed bearings.
  - ▶ **Normal cleanliness**  
Oil filtered through a fine mesh filter; usual conditions for life lubricated bearings, with shields.
  - ▶ **Slight contamination**  
Slight contamination in the lubricant.
  - ▶ **Typical contamination**  
Oil with coarse filtering; wear particles or particles from the ambient environment.  
Usual conditions for greased bearings without integral seals.
  - ▶ For **heavy contamination**, consider that  $a_{ISO}$  will be less than 0.1.
3. From the loads applied on the bearing, compute the equivalent load, P, and the static capacity / equivalent load ratio:  $C_0 / P$ .
4. On the graphic corresponding to the type of bearing or thrust bearing to be evaluated, define point A versus pollution level and  $C_0/P$ .
5. Define point B from the mean diameter of the bearing:  
 $dm = (\text{bore} + \text{outer diameter}) / 2$
6. Define point C versus bearing rotating speed.
7. Define point D versus lubricant viscosity at operating temperature.
8. Point E, at intersection between the straight line from points B and D defines the  $a_{ISO}$  value zone.

# Corrected nominal life (continued)

## Ball bearings: $a_{ISO}$ factor estimation

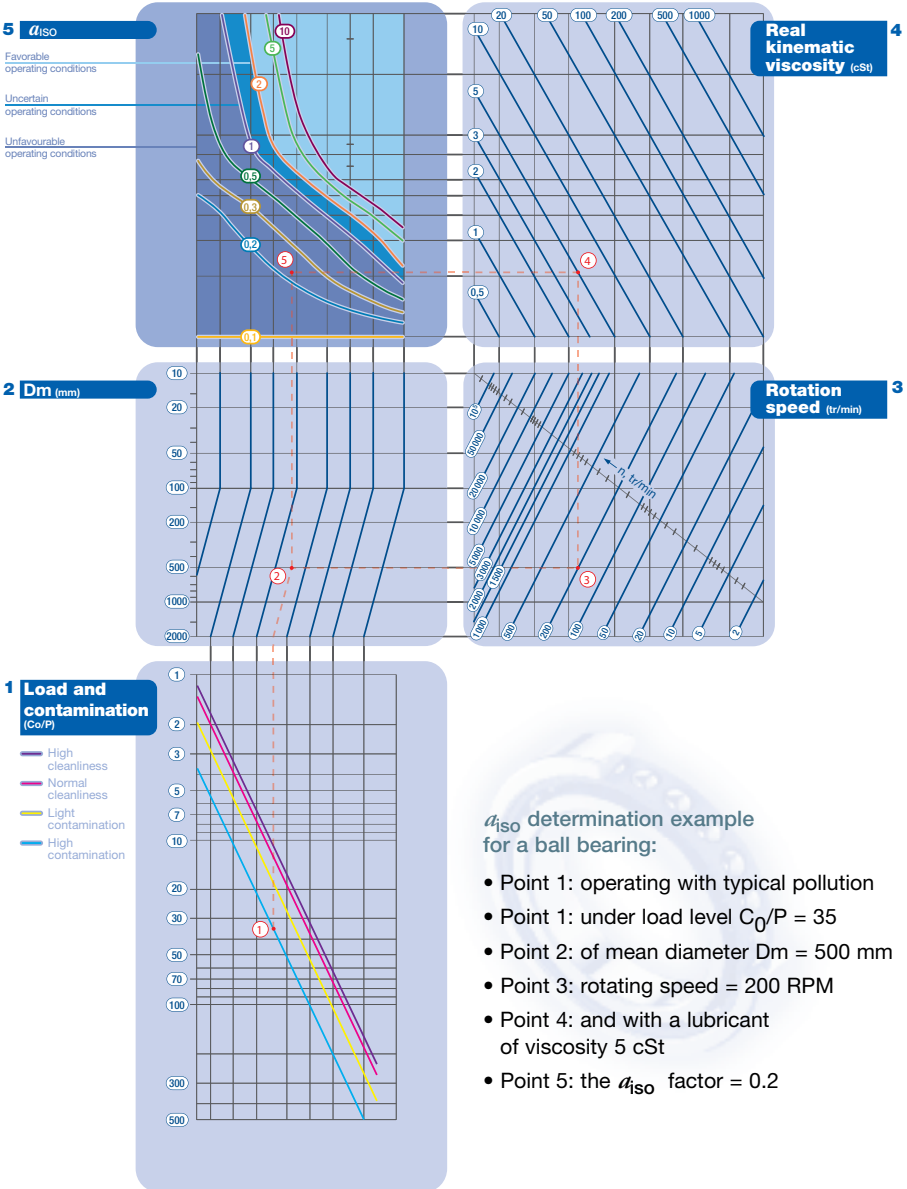



## Roller bearings: $a_{ISO}$ factor estimation

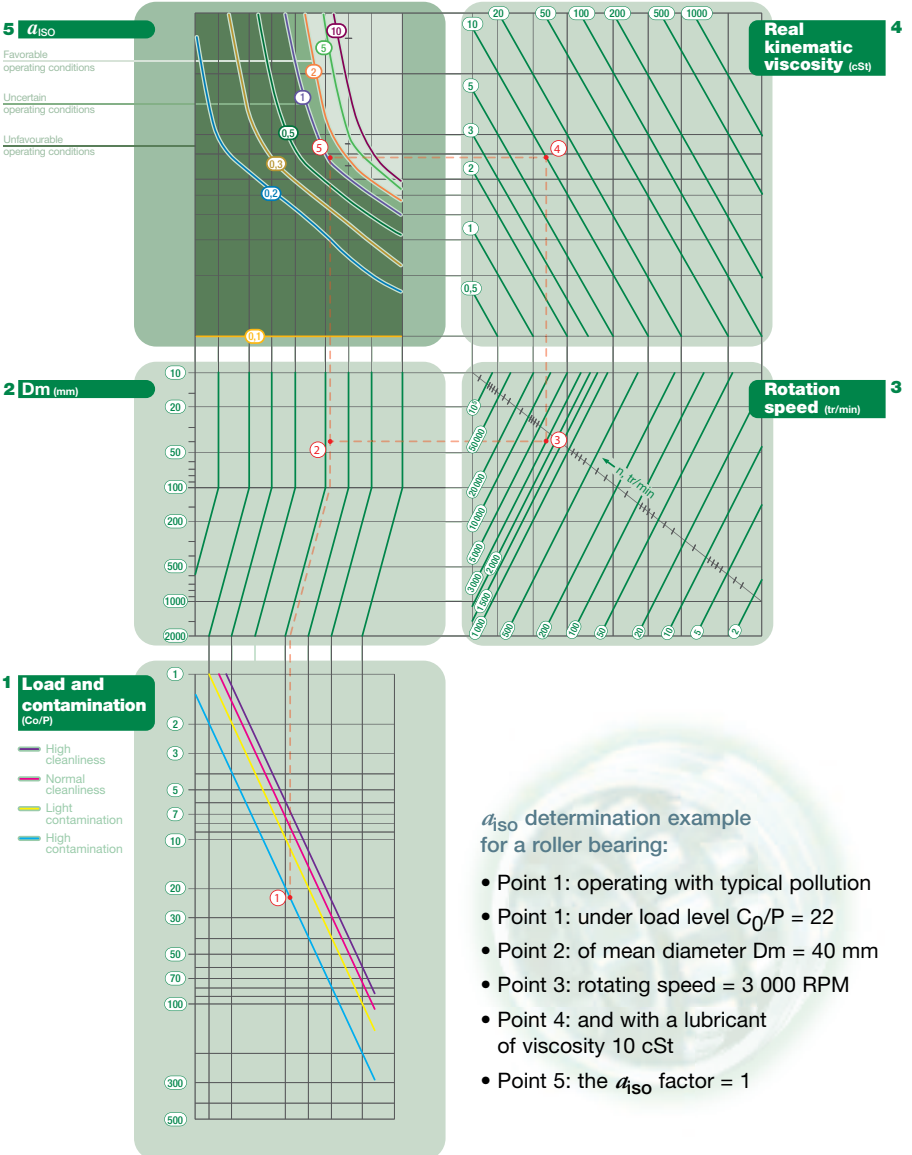

# Corrected nominal life (continued)

## Ball thrust bearings: $a_{ISO}$ factor estimation

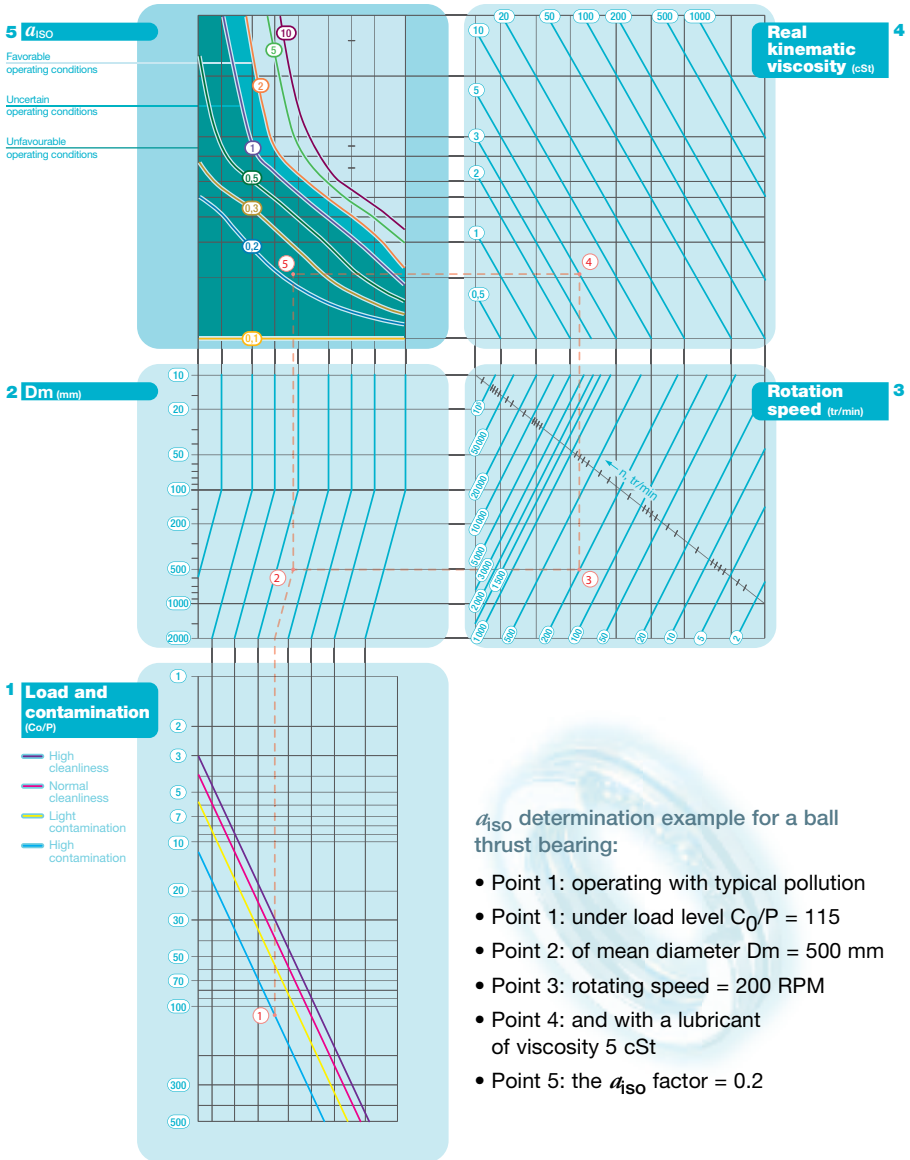

## Roller thrust bearings: $a_{ISO}$ factor estimation

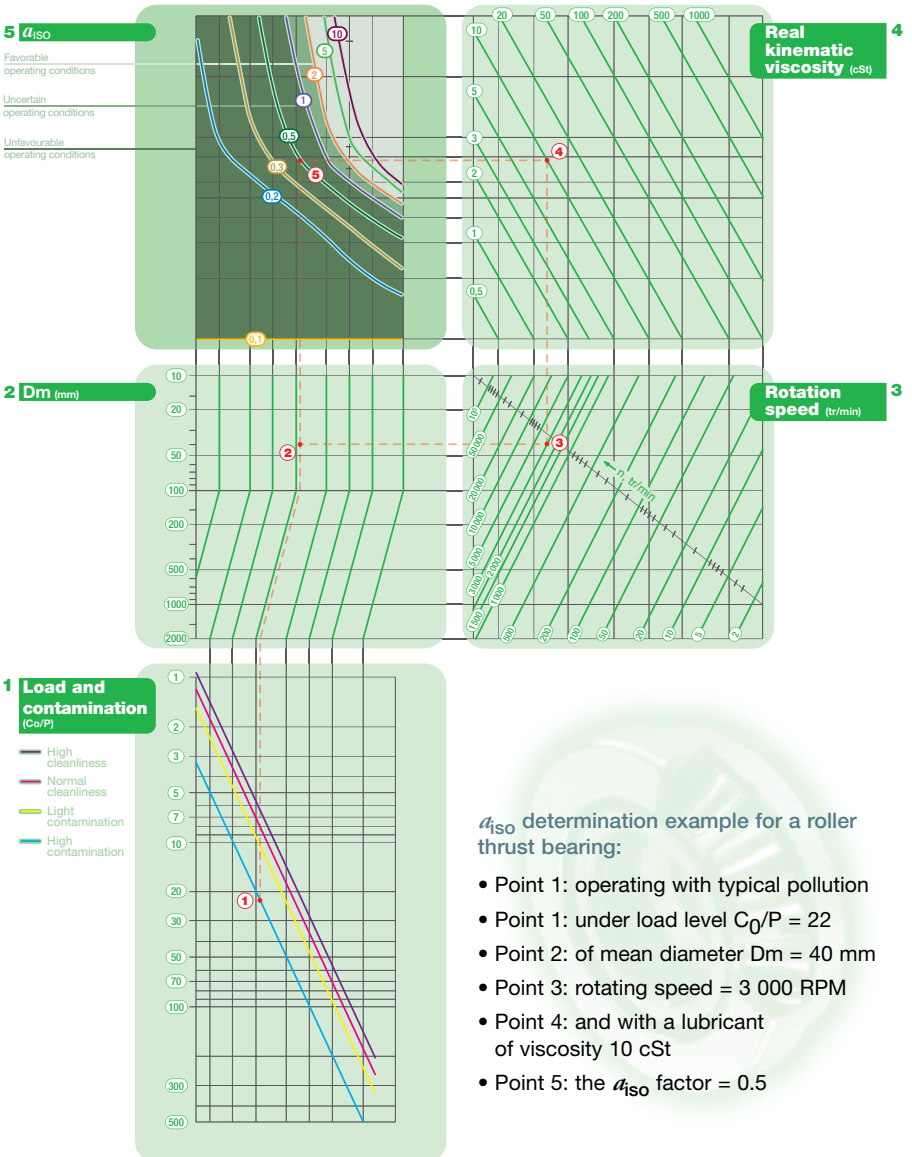

## Corrected nominal life (continued)

### Bearing reliability

■ As with any material fatigue phenomenon, the occurrence of bearing damage displays a random character.

Thus, identical bearings manufactured from the same batch of material, having identical geometrical characteristics, subjected to identical operating conditions (load, speed, lubrication, etc.) will fail after very different operating times.

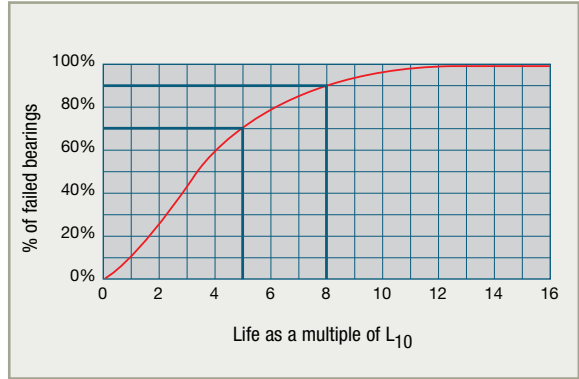

The reference for bearing life is the  $L_{10}$  duration which is given for a 90% reliability, or conversely, a 10% probability of failure. It is possible to calculate a service life for a different level of reliability using the factor  $a_1$ , or to find the reliability  $F$  for a chosen operating time.

#### → Definition of the $a_1$ factor

■ The reliability value  $F$  for an operating time  $L$  is expressed mathematically as a function of the reference time  $L_{10}$

$$F = \exp \left( \ln 0.9 \left( L / L_{10} \right)^\beta \right)$$

hence

$$a_1 = ( L / L_{10} ) = ( \ln F / \ln 0.9 )^{1/\beta}$$

The correction factor  $a_1$  has been calculated with a straight line of Weibull (see graphic on the next page)  $\beta = 1.5$  (mean value for all bearings and thrust bearings).

- These reliability values show the large variation that is characteristic of bearing service lives:
- about 30% of the bearings in a given batch reach a life duration of 5 times the nominal life  $L_{10}$
- about 10% attain a life duration of 8 times the nominal life  $L_{10}$  (see graphic above)

In view of this, bearing performance can only be analyzed after several identical tests and only the statistical analysis of the results enables valid conclusions to be drawn.

## → Reliability for a chosen operating time

■ It is often useful to calculate the reliability of a bearing for relatively short operation times, such as the reliability of a component during its warranty period  $L$ , knowing the calculated service life  $L_{10}$

The analysis of the results of tests performed by SNR has enabled the plotting of the Weibull line to be improved for short operating times.

Unlike what the previous formulae express (taken into account ISO 281 standard for the calculation of the  $a_1$  factor) there is an operating time value below which the bearing displays no risk of failure (100% reliability). This value is roughly equivalent to 2.5% of the life  $L_{10}$  (Figure above:  $\alpha L_{10}$ ).

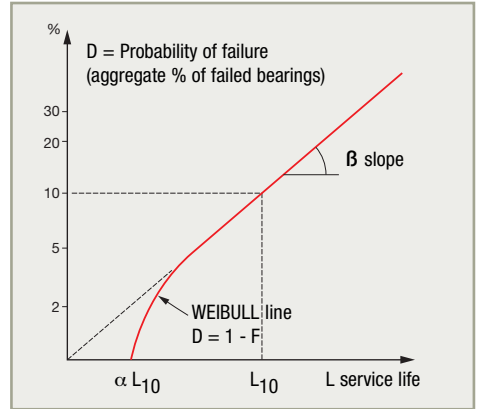

■ To take into account these facts in the reliability calculations for short operating periods, SNR ROULEMENTS uses the previous formula corrected by a factor  $\alpha = 0,05$

$$F = \exp \left( \ln 0.9 \left( \left( \frac{L}{L_{10}} - \alpha \right)^\beta (1 - \alpha)^{-\beta} \right) \right)$$

For any reliability  $F$  there is a corresponding probability of failure  $D = 1 - F$

This probability can be illustrated on a Weibull diagram (in compound logarithmic coordinates) by a straight line with a  $\beta$  slope.

## → Determining $a_1$ and reliability for a chosen life duration

Reliability 100%	$L_{nm}$	$a_1$
90	$L_{10m}$	1
95	$L_{5m}$	0.64
96	$L_{4m}$	0.55
97	$L_{3m}$	0.47
98	$L_{2m}$	0.37
99	$L_{1m}$	0.25
99.2	$L_{0,8m}$	0.22
99.4	$L_{0,6m}$	0.19
99.6	$L_{0,4m}$	0.16
99.8	$L_{0,2m}$	0.12
99.9	$L_{0,1m}$	0.093
99.92	$L_{0,08m}$	0.087
99.94	$L_{0,06m}$	0.080
99.95	$L_{0,05m}$	0.077

## Corrected nominal life (continued)

### ■ Reliability and probability of failure for a chosen duration L

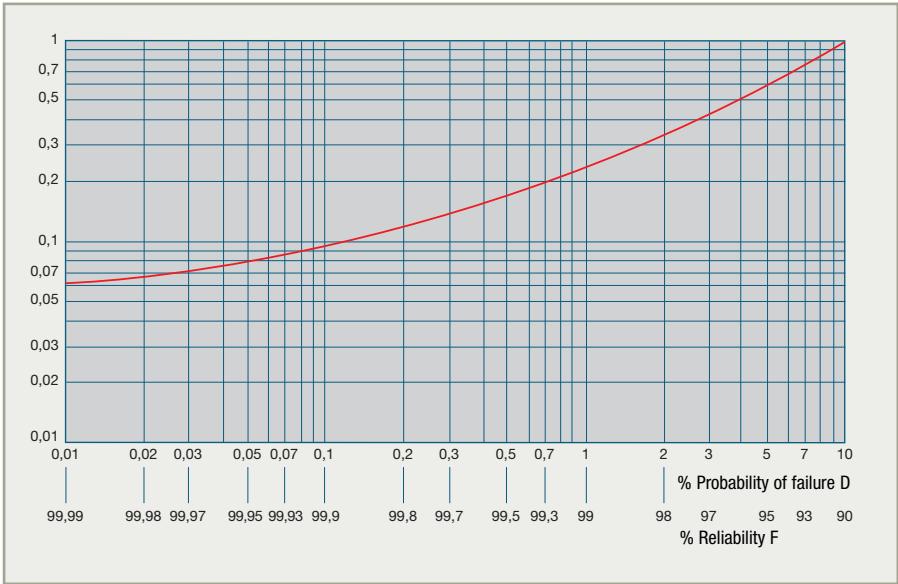

### ➔ Duration and reliability of a set of bearings

■ According to compound probability theory, the reliability of a set of bearings is the product of the reliabilities of its component bearings.

$$F = F_1 \times F_2 \times \dots$$

■ From the previous formula, the life duration  $L_{10}$  of a set is calculated from the duration  $L_{10}$  of each of the component bearings.

$$L_e = (1 / L_1^{1,5} + 1 / L_2^{1,5} + \dots)^{-1/1,5}$$

■ Similarly, the probability of failure of a set is, at an initial approximation, the sum of the probabilities of failure of each bearing (for very low failure values).

$$D = D_1 + D_2 + \dots$$

➔ It can be seen that the longer the life of the individual bearings in an assembly, the greater the reliability of that assembly.

## Influence of lubrication

The main function of the lubricant is to separate the active surfaces of the bearing by maintaining a film of oil between the rolling elements and their raceways in order to avoid wear and limit abnormal stresses and heating in the metal-on-metal contact area.

The lubricant has two secondary functions: cooling the bearing when the lubricant is oil, and preventing oxidation.

### → Separating power of the lubricant

■ In the area of contact between the rolling elements and the raceway, the Hertz theory can be used to analyse the elastic deformation resulting from the contact pressures.

In spite of these pressures, it is possible to create a film of oil that separates the contacting surfaces. The bearing lubrication system is then characterized by the ratio between the oil film thickness  $h$  and the equivalent roughness  $\sigma$  of the surfaces in contact.

$$\sigma = (\sigma_1^2 + \sigma_2^2)^{1/2}$$

$\sigma_1$  : mean roughness of the ring raceways

$\sigma_2$  : mean roughness of the rolling elements

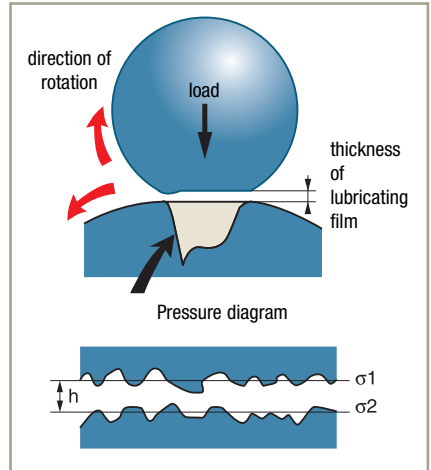

### → Elasto-hydrodynamic theory (EHD)

■ The elasto-hydrodynamic theory takes into account all the parameters involved in the calculation of elastic deformation of the steel and the hydrodynamic pressures of the lubricant, and can be used to evaluate the thickness of the oil film.

These parameters are:

- nature of the lubricant defined by the dynamic viscosity of oil at the operating temperature and its piezoviscosity coefficient which characterizes the increase of viscosity as a function of the contact pressure,
- nature of the materials in contact defined by their E modulus and Poisson ratio, which characterize the amplitude of the deformation at the contact points,
- the load on the most heavily stressed rolling element,
- the speed
- the shape of the contact surfaces defined by their principal crowning radii which characterize the type of bearing used.



Application of the EHD theory to the bearing leads to simplifying hypotheses which show that the thickness of the oil film is virtually solely dependent on the viscosity of the oil and the speed.

## Corrected nominal life *(continued)*

### Oil lubrication

Tests have shown that the lubrication efficiency defined by the ratio  $h/\sigma$  has a great influence on the effective service life of the bearings. By applying the EHD theory one can check the effect of the lubrication system on bearing life in the diagram of the next page.

### Grease lubrication

Application of the EHD theory to lubrication with grease is more complex due to the numerous constituents of the grease. The experimental results rarely show a correlation between the performance and the characteristics of their components. The result is that any recommendation concerning grease is based on tests which are made for a comparative evaluation of the products available on the market. The SNR Research and Test Centre works in close collaboration with the Petroleum Product Research Centres in order to select and develop the highest-performance greases.

## → Determining the minimum required viscosity

### Viscosity-temperature diagram

The oils used for the lubrication of bearings are usually mineral oils with a viscosity number of about 90. The suppliers of these oils give the precise characteristics of their products, and in particular the viscosity-temperature diagram.

If this diagram is not provided, the general diagram shown below shall be used.

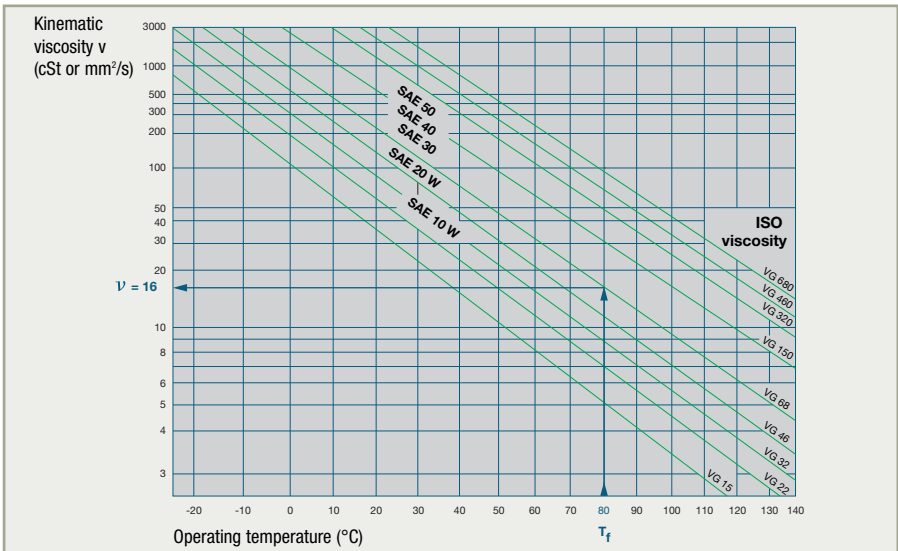

As the oil is defined by its nominal viscosity (in centistokes) at a nominal temperature of  $40^{\circ}\text{C}$  ( $104^{\circ}\text{F}$ ), its viscosity at the operating temperature is calculated from this.



## ■ Diagram of the minimum required viscosity

The diagram below can be used to determinate the minimum required viscosity (in cSt) from:

- Mean diameter of the bearing  $D_m = (D+d)/2$
- Speed of rotation  $n$

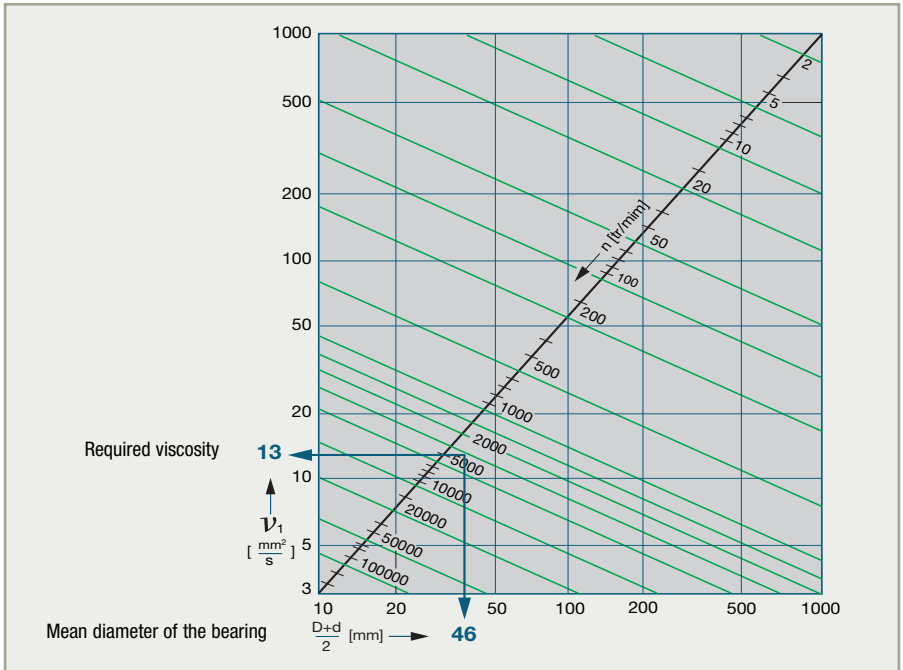

### ► Example:

Bearing 6206 rotating at 3,000 rpm in a VG68 oil at 80°C (176°F).

The opposite diagram indicates that the actual viscosity of the oil at 80°C (176°F) is 16 cSt.

The above diagram indicates that the required viscosity for a 6206 bearing of average diameter  $D_m = (D + d)/2 = 46$  mm at 3,000 rpm is 13 cSt.

# Parameters influencing bearing life

## Influence of the temperature

### → Normal operating temperatures

■ The normal operating temperature of the bearing is between  $-20^{\circ}\text{C}$  ( $-4^{\circ}\text{F}$ ) and  $+120^{\circ}\text{C}$  ( $+248^{\circ}\text{F}$ )

A temperature outside these operating limits has an effect on:

- the characteristics of the steel
- the internal operating clearance
- the properties of the lubricant
- the efficiency of the seals
- the resistance of synthetic material cages

### ■ Conditions for bearing operation outside "normal" temperature limits

Continuous operating temperature in  $^{\circ}\text{C}$

	-40	-20	0	40	80	120	160	200	240
Steel 100 Cr6	Standard					Reduction in fatigue strength Special heat treatment			
Operating Clearance	Normal					Increased clearance			
Grease	Special low temp.	Standard			Drop in performance		Special high temperature	Dry lubrication	
Seal	Standard (acrylic nitrile)								
			Special (fluoroelastomer)						
Cage	Polyamide 6.6								
	Metallic								

# Influence of the operating clearance

## → Radial-contact bearing under radial load

■ The basic dynamic load of a bearing is defined assuming that the radial operating clearance (bearing clearance after fitting) is zero, that is to say that half of the rolling elements are loaded.



■ In practice, the operating clearance is never zero.

- A large clearance (Zone a) causes the load to be supported by a reduced sector of the bearing
- An excessively high preload (Zone b) causes the rolling elements to support a high load in addition to the operating loads.

In both cases the bearing life is reduced, but a preload is more penalizing than a clearance.

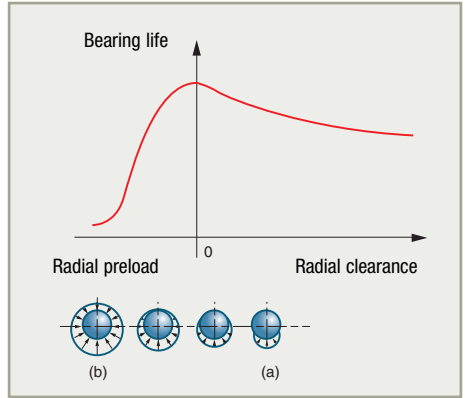

## → Angular contact bearing under radial and axial loads

■ The load zone varies depending on the amount of clearance or preload.



A slight axial preload (Zone c) brings a better load distribution on the rolling elements and increases the bearing life.

It will be noted that a normal axial clearance (Zone a) does not penalize lifetimes very much, while an excessive preload (Zone b) reduces them significantly and causes, in addition to the abnormal stresses, a high rotational torque and a rise of temperature.

This is why the majority of assemblies that do not require a preload have a certain amount of clearance to eliminate these risks and facilitate adjustment and lubrication.

The influence of the clearance on bearing life is calculated from the residual clearance, the size and the direction of the loads applied.

Consult SNR.

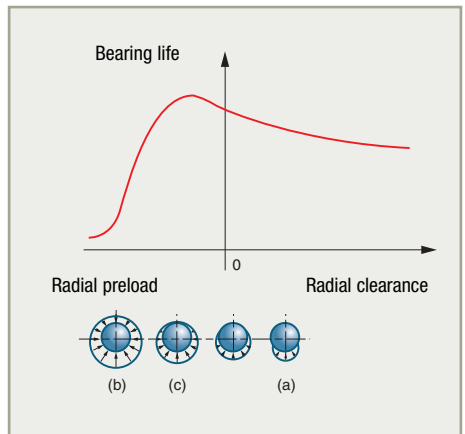

## Parameters influencing bearing life *(continued)*

### Influence of an excessive load

Under very high loads, corresponding approximately to values  $P \geq C / 2$ , the stress level in standard steel is such that the formula no longer correctly represents the nominal life with 90% reliability. These high load applications deserve a specific study using our computing resources.

### Influence of form and position defects

#### → Shape defects

■ The bearing is a precision part and the calculation of its fatigue strength implies having a uniform and continuous distribution of the load between the rolling elements.

If the load distribution is not uniform, the stresses have to be calculated using the finite element method.

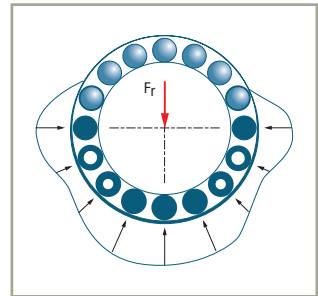

→ It is important for the bearing seats to be machined with a compatible level of precision. Seat shape defects (ovality, cylindricity defect, etc.) create local stresses that significantly reduce the service life of the bearings. Tables on page 108 give certain tolerance specifications for bearing contact surfaces and seats.

#### → Misalignment

■ Misalignment of bearings (very bad for non self-aligning or spherical bearings) results in an angle between the centreline of the inner ring and that of the outer ring.

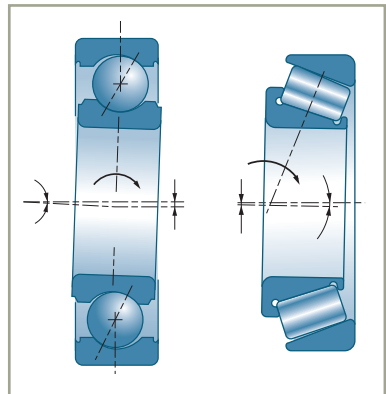

■ Such defects can arise from:

- ▶ a concentricity defect between the two contact surfaces of the shaft or the housings,
- ▶ misalignment between the centreline of the shaft and the centreline of the corresponding housing of a given bearing,
- ▶ a shaft linearity defect,
- ▶ a defect in perpendicularity between the shoulders and the seats.

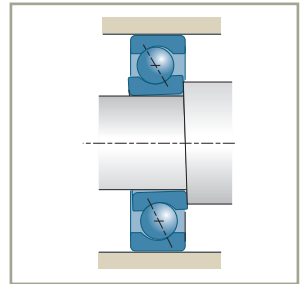
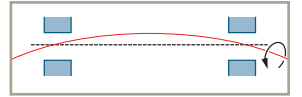
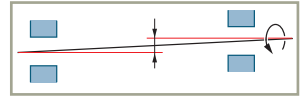

■ The value of these alignment errors and the influence on bearing life is determined by calculation. The diagram below shows the results.

It shows that the drop in service life is very fast and that alignment errors must be kept within very narrow tolerances.

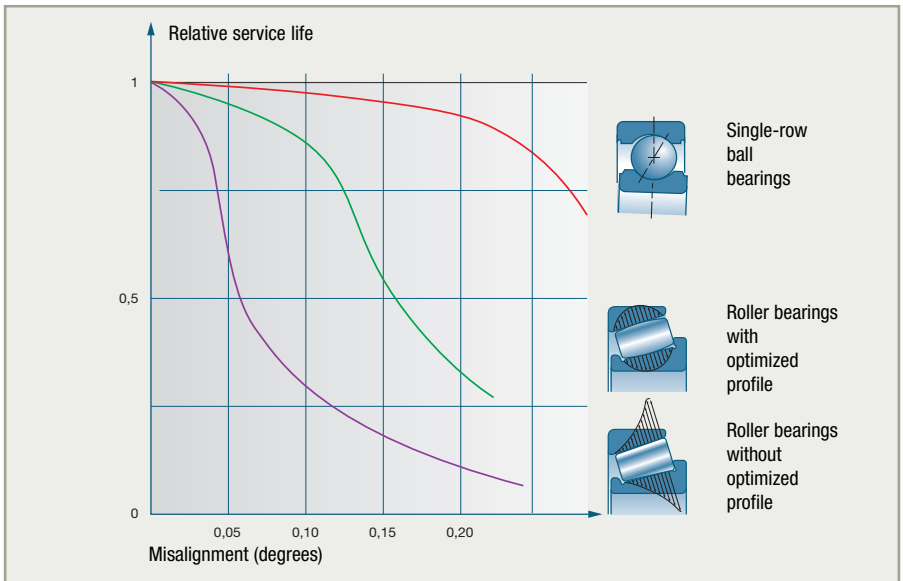

## Parameters influencing bearing life *(continued)*

■ Maximum permissible misalignment value with normal operating clearance without significantly penalizing service life.

	$F_a / F_r < e$	$F_a / F_r > e$
Single-row ball bearing	0.17°	0.09°
Double-row rigid ball bearing, Cylindrical or tapered roller bearing	0.06°	0.06°

To reduce the influence of misalignment in single-row ball bearings one can use an increased clearance (category 3).

With cylindrical or tapered roller bearings, SNR makes convex tracks of the rollers which improves the stress distribution in the event of misalignment.

## Friction and bearing speed

### Friction

■ The friction and consequent heating of a bearing depend on various parameters: the applied load, friction of the cage, internal design of bearing, lubrication, etc.

For the majority of applications below the maximum speed and with non-excessive lubrication, the friction in the bearings can be calculated sufficiently using the following formula:

$M_R$	Moment of resistance (N.mm)
$P_R$	Power consumption (W)
$F$	Radial load for bearings, axial load for thrust bearings (N)
$D_m$	Mean diameter of bearing $D_m = (d + D) / 2$ (mm)
$n$	Speed of rotation ( $\text{min}^{-1}$ )
$\mu$	Friction coefficient

$$M_R = \mu \cdot F \cdot D_m / 2$$

$$P_R = M_R \cdot n / 9550$$

Bearings without seals:

Friction coefficient	$\mu$
Radial ball bearings	0,0015
Self-aligning ball bearings	0,0010
Angular contact ball bearing	
• Single-row ball bearing	0,0020
• Double-row ball bearing	0,0024
Ball thrust bearing	0,0013
Cylindrical roller bearing	0,0050
Tapered roller bearing	0,0018
Spherical roller bearing	0,0018

# Bearing speed

## → Theory of the Standard ISO 15312

ISO Standard 15312 introduces new concepts concerning bearing speeds:

- Thermal reference speed
- Max. admissible thermal speed
- Limit speed

### ■ Thermal reference speed. Definition

This is the rotating speed of the inner race for which **thermal balance** is reached **between heat generated by friction in the bearing ( $N_r$ ) and heat transferred through the bearing seats (shaft and housing) ( $\Phi_r$ )**. This is valid only in the reference conditions below.

$$N_r = \Phi_r$$

### ■ Reference conditions determining heat generation by friction

#### Temperature

- Fixed outer ring temperature  $\theta_{r,} = 70^{\circ}\text{C}$
- Ambient temperature  $\theta_{Ar} = 20^{\circ}\text{C}$

#### Load

- Radial bearings: pure radial load corresponding to 5% of basic static radial load.
- Roller thrust bearings: axial load corresponding to 2% of basic static axial load.

**Lubricant:** mineral oil with extreme pressure additives offering, at  $\theta_r = 70^{\circ}\text{C}$ , the following kinematic viscosity:

- Radial bearings:  $\nu_r = 12 \text{ mm}^2 / \text{s}$  (ISO VG 32)
- Roller thrust bearings:  $\nu_r = 24 \text{ mm}^2 / \text{s}$  (ISO VG 68)

**Lubrication method:** oil bath with oil level up to and including the centre of the rolling body in the lowest position.

#### Others

- Bearing dimensions: up to and including a bore diameter of 1,000 mm
- Internal play: group "N"
- Seals: bearing without seals
- Bearing rotation axis: horizontal  
(For cylindrical roller thrust bearings and needle thrust bearings, take the precaution to supply the upper rolling elements with oil)
- Outer race: fixed
- Preload adjustment in an angular contact bearing: no play in operation

## Friction and bearing speed *(continued)*

- Friction heat,  $N_r$  in a bearing operating at thermal reference speed in the reference conditions:

$$N_r = [(\pi \times n_{\theta r}) / (30 \times 10^3)] \times (M_{0r} + M_{1r})$$

$M_{0r}$  : Friction moment, independent from the load

$M_{1r}$  : Friction moment, dependant on the load

$$N_r = [(\pi \times n_{\theta r}) / (30 \times 10^3)] \times [10^{-7} \times f_{0r} \times (v_r \times n_{\theta r})^{2/3} \times d_m^3 + f_{1r} \times P_{1r} \times d_m]$$

$f_{0r}$  : Correction factor for friction moment **independent from the load but dependant** on speed in the reference conditions (values given for information in Appendix A of the Standard)

$d_m$  : Mean bearing diameter  $d_m = 0,5 \times (D + d)$

$f_{1r}$  : Correction factor for friction moment **dependent on the load**

$P_{1r}$  : Reference load

- Reference conditions determining heat emission

**Reference surface area,  $A_r$** : sum of contact surfaces between races and shaft and housing, through which the thermal flux is emitted.

**Reference heat transfer  $\Phi_r$** : heat generated by the bearing in operation and transmitted by thermal conduction through the reference surface area.

**Heat transfer reference density  $q_r$**  : quotient of reference heat transfer by reference surface area.

- Heat transfer through seating surfaces

$$\Phi_r = q_r \times A_r$$

- Max. admissible thermal speed. Definition

A bearing in operation can reach a max. admissible thermal speed which depends on the thermal reference speed. ISO standard 15312 indicates the computation method for this speed.

- ISO 15312 limit speed. Definition

ISO standard 15312 defines the limit speed of a bearing as the speed which can no longer be sustained by the components.



## → **SNR Theory**

A large majority of bearing applications correspond to speed conditions which are far from critical values. They do not require precise calculations; an indication as to the limit which should not be exceeded is fully sufficient. The definitions and calculation methods developed by the standard ISO 15312 are to be used by specialists who have powerful computing tools, whenever the speed conditions make this calculation indispensable.

This is why, SNR decided to maintain the well tested concept of limit speed in the bearing properties tables.

### ■ **SNR limit speed. Definition**















This is the maximum speed in normal operating conditions, for which internal heating in the bearing is deemed acceptable.

Said limit speed, defined according to standard concepts, is indicated in the product properties table with a differentiation provided for use with grease or with oil.

## Friction and bearing speed *(continued)*

The following table compares the speed capabilities of the different types of bearings.

N.Dm with grease	Types of bearings	N.Dm with oil	
	 Special bearings with appropriate lubrication		
1 100 000	 High-precision ball bearings without preload	+ 55%	<b>Special bearings</b>
650 000	 High-precision ball bearings without preload	+ 55%	
600 000			
550 000			<b>Standard bearings</b>
500 000	 Single-row radial ball bearings	+ 25%	
450 000	 Self-aligning ball bearings	+ 20%	
	 Cylindrical roller bearings	+ 25%	
400 000	 Single-row angular contact ball bearings	+ 30%	
350 000	 Double-row angular contact ball bearings	+ 30%	
	 Double-row angular contact ball bearings	+ 40%	
300 000	 Spherical roller bearings	+ 35%	
	 Tapered roller bearings	+ 35%	
250 000	 Spherical roller thrust bearings (oil lubrication only)		
200 000		+ 40%	
150 000	 Thrust ball bearings		