

CATALOG 300

REALI-SLIM[®]

Ball & Roller Bearings



TURNING IDEAS INTO ENGINEERED SOLUTIONS

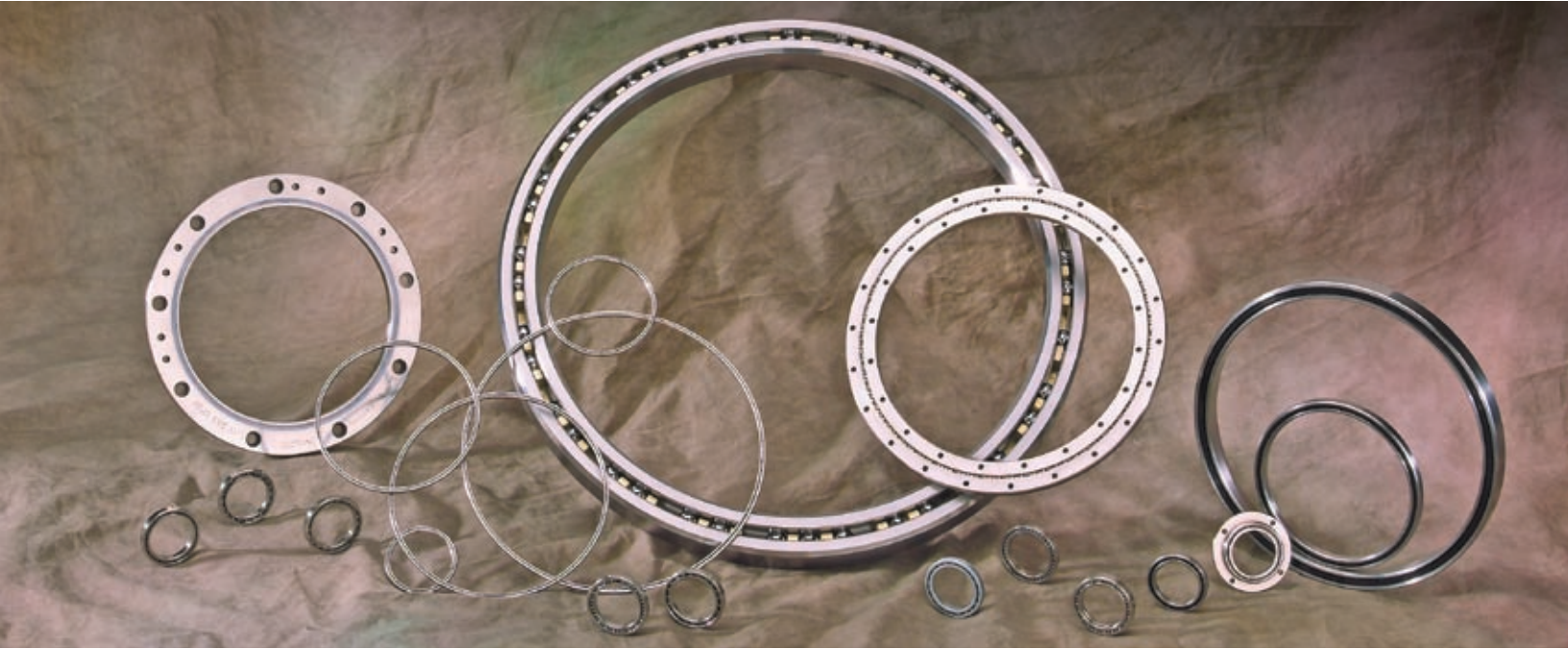

Create space, save weight.



New REALI-SLIM MM™ Metric Series Sealed Bearing Line

Additional REALI-SLIM[®] bearing sizes and enhanced availability



An engineering & product selection guide for thin-section bearings

www.kaydonbearings.com

Identification of REALI-SLIM® Bearings

REALI-SLIM® bearings are marked for complete identification with an (8) or (9) digit part number.

Positions 1-8 identify materials, size, type, and precision. Position 9 (optional) identifies non-standard internal fit.

Part Number Code Example

Position	1	2	3	4	5	6	7	8	9	10-13
Nomenclature	Material	Series	Size			Type	Separator	Precision	Internal Fit	DFAR Compliance
Example	K	G	1	2	0	X	P	0	L	-USA

Position 1 – Material

	Races/Balls	Seals, Shields
A	AISI 52100 Steel	with One seal—PTFE
B	AISI 52100 Steel	with Two seals—PTFE
D	AISI 52100 Steel	with One shield
E	AISI 52100 Steel	with Two shields
F	AISI 52100 Steel	with One seal—Nitrile rubber LAMI-SEAL®
G	AISI 52100 Steel	with Two seals—Nitrile rubber LAMI-SEAL®
H	AISI 52100 Steel	with One seal—Nitrile rubber
J	AISI 52100 Steel	with Two seals—Nitrile rubber
K	AISI 52100 Steel	with No seals or shields
L	AISI 52100 Steel	with Two seals and ENDURAKOTE® plating
M	M-50 Steel	with No seals or shields
N	AISI 52100 Steel	with No seals and ENDURAKOTE® plating
P	AISI 17-4PH Steel	with Ceramic Balls (see Section 6)
Q	AISI 52100 Steel	with No shields or seals (see section 6)
S	AISI 440C Stainless Steel	with No seals or shields
T	AISI 440C Stainless Steel	with One seal—PTFE
U	AISI 440C Stainless Steel	with Two seals—PTFE
V	AISI 440C Stainless Steel	with Two shields
W	AISI 440C Stainless Steel	with Two seals—Nitrile rubber
X	AISI 52100 Steel	with Ceramic Balls
Y	AISI 440C Stainless Steel	with Ceramic Balls (see Section 6)
Z	Other	

Position 2 – Series Cross Section

	Radial Thickness	Width	
Standard Cross-Sections	A	*.187 x .187	
	or	.250 x .250	
	B	.312 x .312	
	C	.375 x .375	
	D	.500 x .500	
	E	.625 x .625	
	F	.750 x .750	
	G	1.000 x 1.000	
	Extended Width	H	*.187 x .250
		or	.250 x .312
I		.312 x .375	
J		.375 x .437	
K		.500 x .578	
L		.625 x .727	
M		.750 x .875	
N		1.000 x 1.187	
Extra-Extended Width		S	*.187 x .312
		or	.250 x .375
	T	.312 x .437	
	U	.375 x .500	
	V	.500 x .656	
	W	.625 x .828	
	X	.750 x 1.000	
	Y	1.000 x 1.375	

*Smaller section applies when position 3 is alphabetic—see following explanations of positions 3, 4, and 5.

IDENTIFICATION OF REALI-SLIM® BEARINGS (continued)**Position 3, 4 and 5—Size (Bearing Bore)****Numeric Characters**

Nominal bearing bore in inches multiplied by ten

Alphabetic Characters

"A" In Position 3 in combination with "A" in Position 2 denotes .187 x .187 Series

"A" In Position 3 in combination with "H" in Position 2 denotes .187 x .250 Series

"A" In Position 3 in combination with "S" in Position 2 denotes .187 x .312 Series

Examples

040 = 4.0" Bore

120 = 12.0" Bore

400 = 40.0" Bore

"10" following "AA" in Positions 2 & 3 = .187 x .187 Series with 1.0" Bore

"15" following "HA" in Positions 2 & 3 = .187 x .250 Series with 1.5" Bore

Position 6—Bearing Type (see Section 3)

- A Angular contact single bearing (not ground for universal duplexing)
- B Angular contact pair—duplexed back to back
- C Radial contact
- F Angular contact pair—duplexed face to face
- T Angular contact pair—duplexed tandem
- U Angular contact single bearing—ground for universal duplexing
- X Four-point contact
- Z Other

Position 7—Separator (see Section 4)

- C Non-metallic composite, segmental, "snap-over" type
- D Phenolic laminate, one-piece ring "snap-over" type
- E Brass, segmental "snap-over" type
- F Full complement bearing—no separator
- G Nylon one-piece ring, circular pocket
- H Phenolic laminate, one-piece ring with circular pockets
- J Nylon strip separator, circular pockets
- K Phenolic laminate, riveted two-piece ring
- L Nylon, one-piece ring "snap-over" type
- M Formed wire, strip or segmental, "snap-over" type, ball in every pocket
- N Nylon, "snap-over" type
- P Standard formed ring "snap-over" type (material—brass or non-metallic composite)
- Q PEEK, one-piece ring, circular pocket
- R Standard formed ring, circular pocket (material—brass or non-metallic composite)
- S Helical coil springs
- T Stainless steel, formed ring "snap-over" type
- U Stainless steel, formed ring circular pockets

- V Brass, formed ring, "snap-over" type
- W Formed wire, strip or segmental, "snap-over" type
- X PEEK, one-piece, "snap-over" pocket
- Y Brass, formed ring, circular pockets
- Z Other (toroids, slugs, spacer balls or others available)

Position 8—Precision (see Section 3)

(ABEC Specifications are per ABMA Standard 26.2)

- 0 KAYDON Precision Class 1 per ABEC 1F
- 1 KAYDON Precision Class 1 with Class 4 Runouts
- 2 KAYDON Precision Class 1 with Class 6 Runouts
- 3 KAYDON Precision Class 3 per ABEC 3F
- 4 KAYDON Precision Class 4 per ABEC 5F
- 6 KAYDON Precision Class 6 per ABEC 7F
- 8 Other

Position 9—Bearing Internal Fit

- A .0000 to .0005 Clearance
- B .0000 to .0010 Clearance
- C .0005 to .0010 Clearance
- D .0005 to .0015 Clearance
- E .0010 to .0020 Clearance
- F .0015 to .0025 Clearance
- G .0020 to .0030 Clearance
- H .0030 to .0040 Clearance
- I .0040 to .0050 Clearance
- J .0050 to .0060 Clearance
- K .0000 to .0005 Preload
- L .0000 to .0010 Preload
- M .0005 to .0010 Preload
- N .0005 to .0015 Preload
- P .0010 to .0020 Preload
- Q .0010 to .0015 Preload
- R .0015 to .0025 Preload
- S .0020 to .0030 Preload
- Z Other clearance or preload not specified above

- *Type X or C = Diametral Preload or Clearance*
- *Duplexed Type A = Axial Preload or Clearance*

Note: Above internal bearing fits apply to unmounted bearings only. Mounting fits can greatly affect final internal bearing fit.

Position 10-13—DFAR Compliance

All REALI-SLIM® bearings requiring compliance with Defense Federal Acquisition Regulations (DFAR) "Specialty Metals" and "the Restrictions on Acquisition of Ball and Roller Bearings" clauses will contain '-USA' in positions 10-13. If internal fit is not called out in position 9, it will also contain a dash.

Example #1: KG120XP0L-USA

Example #2: KG120XP0--USA

REALI-SLIM® — The Industry Leader in Thin-Section Bearings

REALI-SLIM® thin-section bearings are known around the world for creating design space and saving weight. Design engineers across a wide spectrum of industries have trusted KAYDON since 1941 for precision and reliability in the most demanding applications.

Catalog 300 has been relied upon for nearly as long, providing users with the specifications, capacities and sizing charts to choose the right bearing for their needs. Every edition offers more choices than ever, and this update is no exception.

What's New

New Line of Sealed REALI-SLIM MM™ Metric Series Bearings

- We are pleased to introduce a new 8mm series of sealed metric REALI-SLIM® bearings in both Type C (Radial Contact) and Type X (Four-Point Contact). Choose from 28 new part numbers, in bore sizes from 25mm up to 170mm. This new series gives you more versatility when your design calls for a sealed bearing.

Expanded Range of JG Series Sealed REALI-SLIM® Bearings

- The JG series of sealed REALI-SLIM® bearings has added 12 new part numbers to its line-up, with new bore sizes from 7.0 inches to 11.0 inches. The JU and JG series now span a range from 7.0 inches to 40.0 inches.

Handy Conversion Table on Inside Back Cover

- To save you a step and make the catalog even more useful, we've added a table of English-Metric equivalents commonly used by design engineers.

More REALI-SLIM® Part Numbers Available From Stock

- Availability from stock has been enhanced for more than a dozen part numbers since the last catalog revision in 2007.

Easier REALI-SLIM® Part Number Identification

- REALI-SLIM® part number tables have been relocated to the inside front cover, so you can find them immediately.

***For latest releases — catalog, software, or
CAD drawing downloads — visit our website
www.kaydonbearings.com.***

Table of Contents

	Page Number
Section 1— An Introduction to REALI-SLIM® Thin-Section Bearings	7
• Product Line Overview	8
• Examples of Design Efficiency	9
• Bearing Load Scenarios	10
• General Information and Availability Chart.....	12
• General Specifications for Standard Bearings.....	13
Section 2— Selection Tables for Standard REALI-SLIM® Bearings.....	14
• Standard Open REALI-SLIM® Inch Series Bearings, AISI 52100: Types A, C, X.....	15
• Sealed REALI-SLIM® Bearings, AISI 52100: Types C, X	27
• ENDURAKOTE®-plated ENDURA-SLIM® Bearings	35
• Stainless Steel Open REALI-SLIM® Bearings, AISI 440C: Types A, C, X	49
• REALI-SLIM MM™ Metric Series Bearings.....	53
• ULTRA-SLIM® Series Bearings	60
• REALI-SLIM TT® Turntable Series Bearings.....	62
Section 3— Applications Engineering	65
• Selection Recommendations.....	66
• Capacity, Life, and Load Analysis.....	71
• Mounting Recommendations	75
• Precision Classes and Tolerances.....	80
Section 4— Separator Types, Ball Count, and Performance	92
• Separator Types.....	93
• Number of Balls in Standard Bearings	97
• Limiting Speeds	98
• Torque	100
• Axis Deviations	102
• Deflection Curves	104
Section 5— Installation and Maintenance of REALI-SLIM® Thin-Section Bearings	110
• Inspection and Installation Procedures.....	111
• Lubrication and Maintenance.....	113
Section 6— Other Products	115
• Metric BB Series Bearings.....	116
• Bearings for Demanding Applications.....	119
• KT Series Tapered Roller Bearings	121
Section 7— Appendix and Sales Information	122
• Terms and Definitions.....	123
• Warranty Information and Legal Notices	124
• Design Aids and Technical Literature	127
• Request for Bearing Proposal Data Form	129
• Conversion Factors	131

The design and application information contained in this catalog is for illustration only. Responsibility for the application of the products contained in this catalog rests solely with the equipment designer or user. In spite of our best efforts, the material contained in this catalog may contain inaccuracies and typographical errors.

REALI-SLIM®... For Compact, Lightweight Designs of the Future.

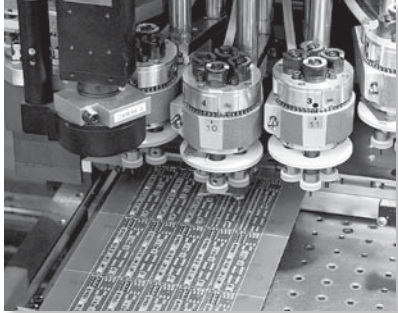

**Semiconductor
Fabrication Equipment**

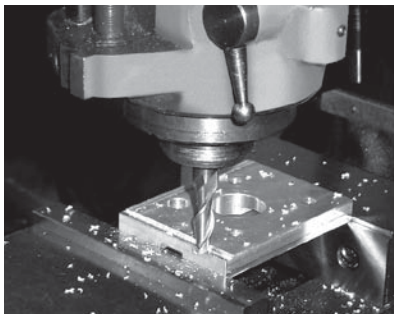

Machine Tools

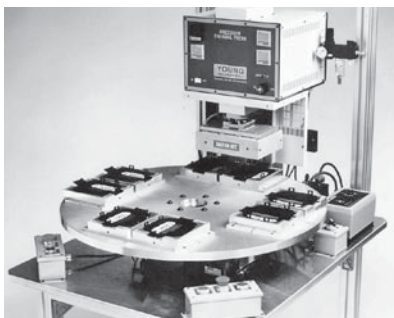

Rotary Table

- Aerospace and astronomy instrumentation
- Fixturing and workholding equipment
- Food processing equipment
- Glassworking equipment
- Index and rotary tables
- Packaging equipment
 - Machine tools
 - Medical devices
- Optical scanning equipment
 - Tire making equipment
 - Radar, satellite and communications equipment
 - Robotics
 - Textile machinery
- Tube and pipe cutting machines
- Semiconductor manufacturing equipment
- Sorting equipment



Textile Printer



Radar

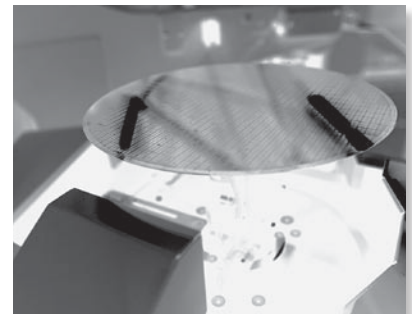

Robotic Silicon Wafer Processing



Armored Vehicle Sights & FLIRs

KAYDON REALI-SLIM® bearings were designed to fill the need for a fully hardened, thin-section, anti-friction bearing—a need resulting from the modern design concepts of simplicity, miniaturization, weight reduction, and compactness being applied to a wide variety of rotating devices.

Before the introduction of REALI-SLIM® bearings,

6 | www.kaydonbearings.com 1-800-514-3066

designers were forced to use bushings or select bearings from the lightest bearings then commercially available, the standard "Light", "Extra-Light", and "Extremely Light" series—many of which often had undesirable cross sections, and excess weight.

REALI-SLIM® bearings overcome the problems of excess weight and size in bearings, shafts, and housings.

Section 1 — An Introduction to REALI-SLIM® Thin-Section Bearings



	Page Number
• Product Line Overview	8
• Examples of Design Efficiency	9
• Bearing Load Scenarios	10
• Product Availability Chart	12
• Specifications for Standard Bearings	13

Product Line Overview

The REALI-SLIM® product line consists of a family of seven open (Figure 1-1) and five sealed (Figure 1-2) series of thin-section bearings ranging in bore diameters from 1.000 inch to 40.000 inches. Series range from .187 x .187 inch to 1.000 x 1.000 inch in cross section. Open bearings are available from stock in three configurations (Types A, C & X). Stock sealed bearings are available in Types C & X only.

We can provide internal fit up, lubricants, separators and other features to meet the most demanding specifications. To obtain corrosion resistance consider using KAYDON stainless steel REALI-SLIM® or ENDURA-SLIM® series of bearings. ENDURAKOTE® plating provides corrosion protection equal to or better than a full AISI 440C stainless steel bearing and can be supplied with very quick delivery.

Additional product line variants include: REALI-SLIM MM™ metric series bearings, ULTRA-SLIM® bearings, and REALI-SLIM TT® series turntable bearings (Section 2); and BB metric ball bearings, Bearings for Demanding Applications, and KT thin-section taper bearings (Section 6).

Within these families, you can generally choose between open bearings for applications where bearings will not be exposed to damaging particulates and sealed bearings for applications where bearings need to be kept clean and well-lubricated.

To support various load scenarios, REALI-SLIM® bearings are available in three basic types: radial contact (Type C), angular contact (Type A), and four-point contact (Type X)—see pages 10 and 11 for explanations on each type—and in a variety of sizes, or series (e.g., KA, KB, KC, etc.).

REALI-SLIM® bearings are available with various separator options to space the rolling elements uniformly and prevent contact between them. Separator types available include: continuous ring “snap-over pocket”, continuous ring circular pocket, formed wire, toroid, PTFE spacers, and spacer ball separators. See Section 4 for complete details.

SPECIFICATION CONTROL

In today's world, product traceability is extremely important. To satisfy these requirements, requesting a “specification control drawing” for a REALI-SLIM® bearing is a valuable option to consider.

A specification control drawing provides the user a concise description of the important bearing features and parameters for a specific bearing. A specification control drawing request will generate a unique part number for the standard REALI-SLIM® bearing, including the commercially available options you have selected. This provides the customer quick and easy identification of product in the field as well as a concise receiving and inspection document for the factory.

The Product Line At a Glance Open Bearings — Figure 1-1

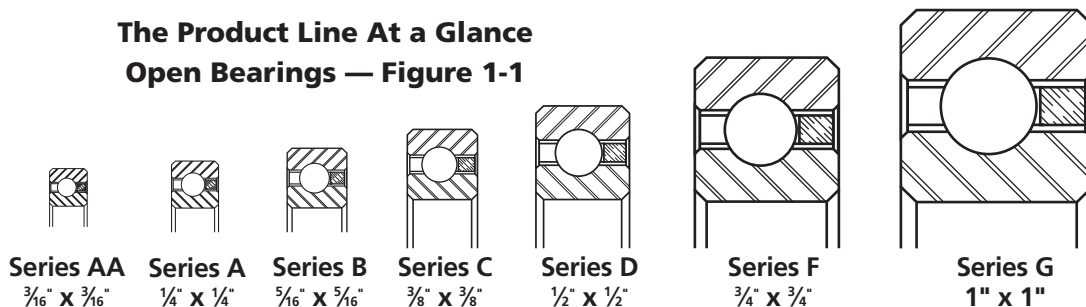

Sealed Bearings — Figure 1-2

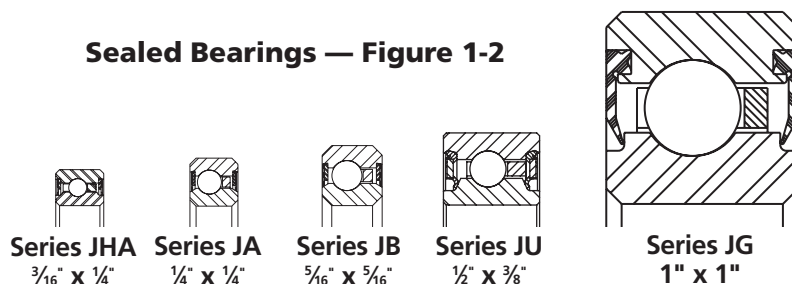

Design Efficiency

REALI-SLIM® Bearings Improve Design Efficiency

In REALI-SLIM® bearings, each series is based on a single cross section which remains constant as the bore diameter is increased. This is in sharp contrast to standard bearings in which the cross section increases as the bore diameter increases. The constant cross section of a REALI-SLIM® bearing is of particular value when designing a product which will be manufactured in various sizes based on shaft diameter and power requirements (Figure 1-3). By using the same series of REALI-SLIM® bearings throughout a product line, the designer can standardize on common components. For all diameters of this rotary table your bearing envelope stays the same.

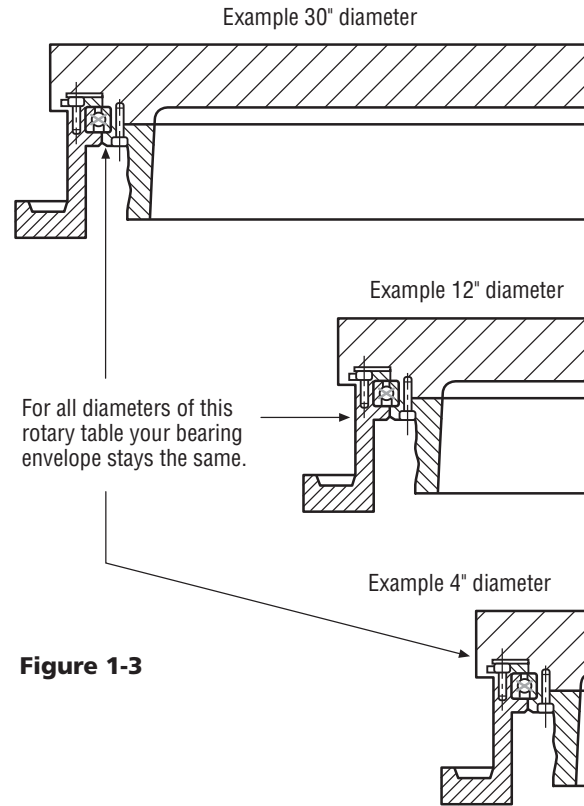

Figure 1-3

REALI-SLIM® Bearings Make a More Compact Design

Additional advantages in application design made possible by REALI-SLIM® bearings can be seen by referring to Figures 1-4, 1-5, and 1-6. A large bore, small cross-section REALI-SLIM® bearing permits the use of a large diameter hollow shaft (Figure 1-5) in place of a smaller diameter solid shaft (Figure 1-4), king-post design. Components such as air and hydraulic lines or electrical wiring and slip rings can then be accommodated within the hollow shaft, resulting in a neater, more efficient design.

In many applications, a single four-point contact REALI-SLIM® bearing (Figure 1-6) can replace two bearings (Figures 1-4 and 1-5) compacting the design and simplifying the bearing mounting. Besides the obvious cost savings of eliminating one bearing, this arrangement also creates space and saves weight. The use of REALI-SLIM® bearings also provides a stiffer structure by using large diameter hollow tubes to replace solid shafts and by supporting the rotating structure (table) at the periphery.

Figure 1-4

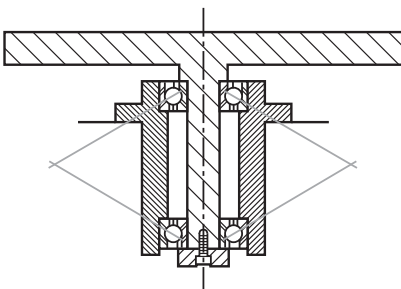

Figure 1-5

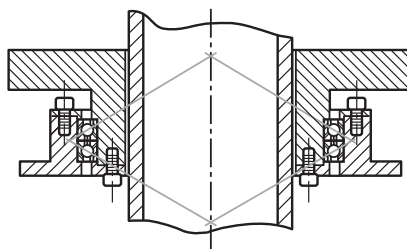
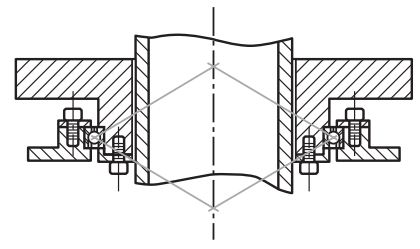

Figure 1-6



REALI-SLIM® Bearing Types Support All Load Scenarios

Radial and Axial (Thrust) Loads

Bearings support a shaft or housing to permit their free motion about an axis of rotation. Load can be applied to bearings in either of two basic directions (Figure 1-7). Radial loads act at right angles to the shaft (bearing's axis of rotation). Axial (thrust) acts parallel to the axis of rotation. When these loads are offset from either the bearing axis (distance S_t) or radial plane (distance S_r), a resulting moment load (M) will be created. KAYDON REALI-SLIM® bearings are available in a variety of types to handle radial loads, axial loads and moment loads.

Figure 1-7

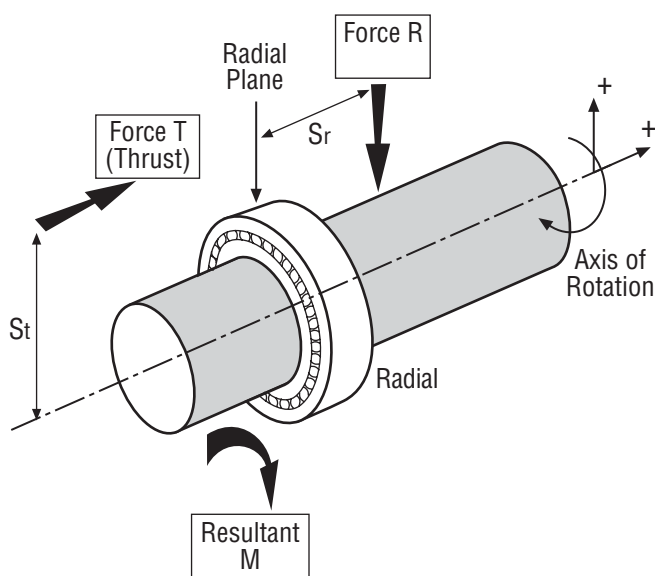

The resultant moment load (M) equation:

$$M = (\pm T) (S_t) + (\pm R) (S_r)$$

Types of REALI-SLIM® Bearings

REALI-SLIM® bearings are available in three basic configurations: radial (Type C), angular contact (Type A), and four-point contact (Type X).

REALI-SLIM® Bearing Types
A = angular
C = radial
X = four-point

By using these three types, the customer has a wider choice of mounting arrangements to meet load, stiffness and accuracy requirements in the most efficient manner.

Radial Contact Bearing (Type C)

The Type C Radial Contact Bearing (Figure 1-8) is a single row radial ball bearing of conventional design. It is a Conrad-type assembly, which means that it is assembled by eccentric displacement of the inner race within the outer race which permits insertion of about half of a full complement of balls.

REALI-SLIM® TYPE C

Figure 1-8

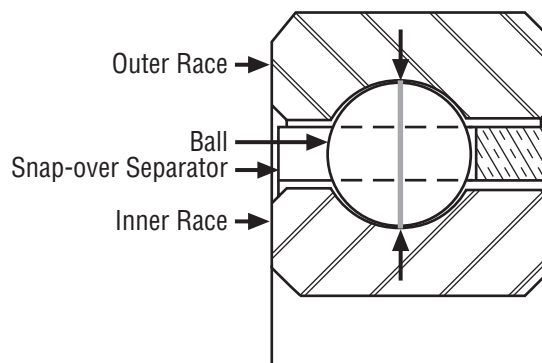

Although the Type C bearing is designed primarily for radial load application, it can be configured to accept some axial (thrust) load in either direction. But, if thrust is a concern, a set of angular contact bearings should be considered for the specific application.

REALI-SLIM® BEARING TYPES SUPPORT ALL LOAD SCENARIOS (continued)**Angular Contact Bearing (Type A)**

The Type A Bearing is also a conventional design. It features a circular pocket separator and a 30° contact angle (see Figure 1-9) along with approximately 67% of a full complement of balls.

The chief benefit of the Type A bearing is that it provides greater thrust capacity than a Type C or Type X bearing. Because of its counterbored outer race, Type A bearings have unidirectional thrust capacity. Thus, this bearing should be mounted opposed to another bearing to establish and maintain the contact angle, and to support reversing thrust loads.

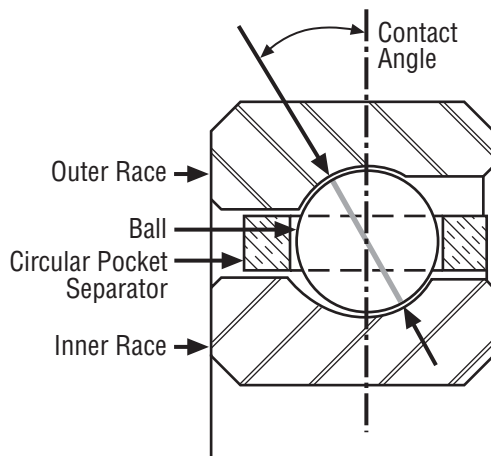
REALI-SLIM® TYPE A**Figure 1-9****Four-Point Contact Bearing (Type X)**

Standard bearing lines are most often designed to handle either radial or axial load conditions. The unique feature about the KAYDON REALI-SLIM® Type X four-point contact bearing line (see Figure 1-10) is that the gothic arch geometry of the inner and outer races enables a single bearing to carry three types of loading (radial, axial and moment) simultaneously. This makes it the bearing of choice for many applications since a single four-point contact bearing can often replace two bearings, providing a simplified design.

Type X bearings may also be furnished with an internal diametral preload for those applications requiring greater stiffness or zero free play. This is accomplished by using balls that are larger than the space provided between the raceways. The balls and raceways, therefore, have some elastic deformation in the absence of an external load.

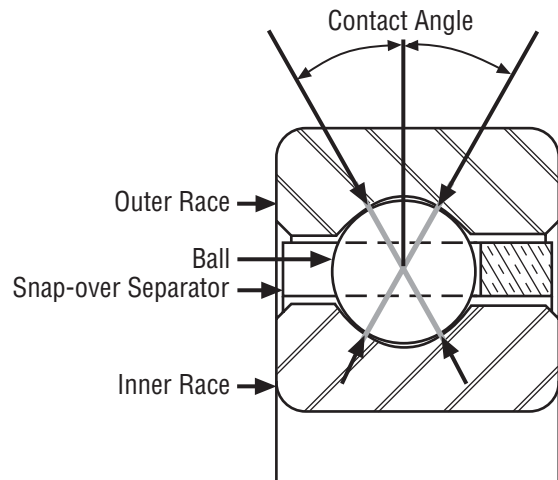
REALI-SLIM® TYPE X**Figure 1-10**

NOTE: KAYDON does not recommend the use of two Type X bearings on a common shaft, as it could result in objectionable friction torque.

General Information and Availability Chart

Standard REALI-SLIM® Bearings—are those listed in the Series Data Tables. They are manufactured to KAYDON Precision Class 1 and the specifications on page 13. New sizes are added to stock periodically and updated on our website. Be sure to visit www.kaydonbearings.com for latest information.

Options

REALI-SLIM® Bearings—can be optimized for your special requirements. Standard commercial options include: changes in diametral clearance, preloading, lubricants, packaging, etching of high points, tagging bearings with actual dimensions as requested, separators, duplexing,

data sheets, acceptance testing, etc.

REALI-SLIM® Bearings—with non-standard materials, sizes, tolerances, specifications, and features are available. We will be pleased to quote on your requirements.

Order REALI-SLIM® Bearings—by bearing numbers shown in Series Data Tables.

Assistance—in bearing selection will be furnished by our regional sales managers or the KAYDON Engineering Department upon request.

Changes—KAYDON reserves the right to change specifications and other information included in this catalog without notice.

Figure 1-11

This table applies to AISI 52100 standard bearings. For stainless steel, please see Section 2.

Series	Type	Bore Diameter In Inches																																			
		1	1½	1¾	2	2½	3	3½	4	4¼	4½	4¾	5	5½	6	6½	7	7½	8	9	10	11	12	14	16	18	20	21	22	25	30	35	40				
JHA Series ¾" Radial Section	A																																				
	C	•	•	•																																	
	X	•	•	•																																	
KAA Series ¾" Radial Section	A	•	•	•																																	
	C	•	•	•																																	
	X	•	•	•																																	
JA Series ¼" Radial Section	A																																				
	C				•	•	•	•	•	•	•	•	*	•	*	*	*																				
	X				•	•	•	•	•	•	•	*	•	*	*	*																					
KA Series ¼" Radial Section	A				•	•	•	•	•	•	•	•	•	•	•	•	•	•	•	*	•	*	*														
	C				•	•	•	•	•	•	•	•	•	•	•	•	•	•	•	•	•	•	*	•	*												
	X				•	•	•	•	•	•	•	•	•	•	•	•	•	•	•	•	•	•	*	•	*												
JB Series ⅝" Radial Section	A																																				
	C				•	•	•	•	•	•	•	•	*	*	*	*	*																				
	X				•	•	•	•	•	•	•	•	*	*	*	*	*																				
KB Series ⅝" Radial Section	A				•	•	•	•	•	•	•	•	*	*	•	•	*	*	*	*	*	*	*	*	*	*	*	*	*	*	*	*	*	*	*		
	C				•	•	•	•	•	•	•	•	*	*	•	•	*	*	*	*	*	*	*	*	*	*	*	*	*	*	*	*	*	*	*		
	X				•	•	•	•	•	•	•	•	*	*	•	•	*	*	*	*	*	*	*	*	*	*	*	*	*	*	*	*	*	*	*		
KC Series ¾" Radial Section	A								•	*	•	•	•	•	•	•	•	•	•	•	•	*	•	*	*	*	*	*	*	*	*	*	*	*	*		
	C								•	•	•	•	•	•	•	•	•	•	•	•	•	*	•	*	*	*	*	*	*	*	*	*	*	*	*		
	X								•	*	•	•	•	•	•	•	•	•	•	•	*	•	*	*	*	*	*	*	*	*	*	*	*	*	*		
JU Series ⅝" Radial Section	A																																				
	C								•	*	•	•	•	•	•	•	•	•	•	•	•	•	*	•	*												
	X								•	*	•	•	•	•	•	•	•	•	•	•	•	*	•	*													
KD Series ½" Radial Section	A								•	•	•	•	•	•	•	•	•	•	•	•	•	*	•	*	*	*	*	*	*	*	*	*	*	*	*		
	C								•	•	•	•	•	•	•	•	•	•	•	•	•	*	•	*	*	*	*	*	*	*	*	*	*	*	*		
	X								•	•	•	•	•	•	•	•	•	•	•	•	•	*	•	*	*	*	*	*	*	*	*	*	*	*	*		
KF Series ¾" Radial Section	A																																				
	C																																				
	X																																				
JG Series 1" Radial Section	A																																				
	C																																				
	X																																				
KG Series 1" Radial Section	A																																				
	C																																				
	X																																				

• Available from stock. * Limited Availability – contact KAYDON for lead time and minimum purchase requirement.

Specifications for Standard REALI-SLIM® Bearings

ITEM	DESCRIPTION	REFERENCE SPECIFICATION
MATERIAL ANALYSIS		
RACES & BALLS	AISI 52100 Type Steel Vacuum Degassed AISI 440C Stainless Steel	ASTM A-295, AMS-STD-66 ASTM A-756
SEPARATORS C, X BEARINGS	P Type—Brass or Non-metallic composite L Type—Nylon, Fiberglass Reinforced	ASTM B-36 or B-134
A BEARINGS	R Type—Brass or Non-metallic composite G Type—Nylon, Fiberglass Reinforced	ASTM B-36 or B-134
SEALS	Nitrile Rubber, 70 Durometer, Steel Reinforced	MIL-R 6855
HEAT TREATMENT		
RACES	Through hardened and dimensionally stabilized for use from -65°F to +250°F (-54°C to +121°C)	
BALLS	AISI 52100—Hardened to Rc 62-66, AISI 440C—to Rc 58-65	
PRECISION		
RACE DIMENSIONS	KAYDON Precision Class 1	ABMA ABEC-1F or better
RACE RUNOUTS	KAYDON Precision Class 1	ABMA ABEC-1F or better
BALLS	ABMA Grade 10	ANSI/ABMA/ISO 3290
DIAMETRAL CLEARANCE AND CONTACT ANGLE		
TYPE C BEARING	Sufficient diametral clearance to provide small amount of running clearance after installation with recommended fits Gothic Arch Form for two 30° contact angles under light radial gaging load. Sufficient diametral clearance to provide clearance after installation with recommended fits Diametral clearance for 30° contact angle in single unmounted bearing under light axial gaging load. Wide range of preload or running clearance for matched sets	ABMA Standard 26.2
TYPE X BEARING		
TYPE A BEARING		
SEPARATOR DESIGN		
P & L TYPES C, X BEARINGS R & G TYPES A BEARINGS	Circular Ring, Snapped Over Balls for Retention Circular Ring, Circular Pockets, Self Retained	
OTHER		
QUALITY CONTROL	KAYDON Quality Control procedures have been approved by major aerospace industries and agencies of the U.S. Government	ISO 9001
IDENTIFICATION	Marked on Bearing O.D.: CAGE Code, "KAYDON"®, Part Number and Date Code	MIL-STD-130
CLEANING	Multiple cycle immersion and agitation in solvents and/or aqueous cleaners	
PRESERVATIVE	Preservative Oil	
PACKAGING	Heat Sealed in Plastic Bag & Boxed	

NOTE—Also available: Quality Control per MIL-Q-9858, Packaging and Lubrication options, and "Clean Room" Facilities.

Section 2 — Selection Tables for Standard REALI-SLIM® Bearings

	Page Number
• Open Bearings Inch Series – AISI 52100, Selection Tables - Types A, C, X.....	15
• Sealed Bearings – AISI 52100, Selection Tables - Types C, X.....	27
• ENDURAKOTE® - Plated Bearings Overview & Selection Tables	35
• Open Bearings - AISI 440C, Overview & Selection Tables - Types A, C, X	49
• Open Bearings Metric Series - AISI 52100, Selection Tables - Types A, C, X	53
• ULTRA-SLIM® Bearings Overview & Selection Tables - Types A, C, X	60
• REALI-SLIM TT® Turntable Series Overview & Selection Tables	62

Open REALI-SLIM® Bearing Selections

Type A Angular Contact

A deep groove bearing with reduced shoulder on one side of inner or outer race ball path. Snapover assembly permits use of a one-piece circular pocket separator and greater ball complement. These bearings will accept radial load and single direction thrust load and are normally used in conjunction with another bearing of similar construction. Type A bearings require the

application of thrust to establish contact angle. Stock bearings are individual units and when purchased as such must be adjusted at installation to desired running clearance or preload. If preferred, matched sets are available. KAYDON also offers matched spacers for applications requiring extra precision. KAYDON® can provide this service direct from the factory.

KAA SERIES										
KAYDON Bearing Number	Dimensions in Inches					Capacities in Pounds ^①				Approx. Weight in Pounds
	Bore	Outside Dia.	Land Dia. L ₁	Land Dia. L ₂	C'Bore Dia. L ₃	Radial		Thrust		
						Static ^②	Dyn.	Static ^②	Dyn.	
KAA10AG0	1.000	1.375	1.140	1.235	1.274	340	194	970	450	.025
KAA15AG0	1.500	1.875	1.640	1.735	1.774	480	238	1,380	560	.038
KAA17AG0	1.750	2.125	1.890	1.985	2.024	530	251	1,520	600	.045

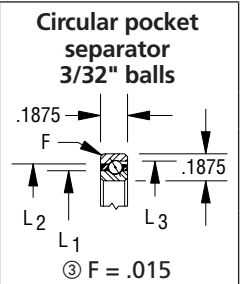

KA SERIES										
KAYDON Bearing Number	Dimensions in Inches					Capacities in Pounds ^①				Approx. Weight in Pounds
	Bore	Outside Dia.	Land Dia. L ₁	Land Dia. L ₂	C'Bore Dia. L ₃	Radial		Thrust		
						Static ^②	Dyn.	Static ^②	Dyn.	
KA020AR0	2.000	2.500	2.186	2.314	2.369	790	405	2,280	960	.10
KA025AR0	2.500	3.000	2.686	2.814	2.869	960	459	2,780	1,100	.12
KA030AR0	3.000	3.500	3.186	3.314	3.367	1,140	507	3,290	1,230	.14
KA035AR0	3.500	4.000	3.686	3.814	3.867	1,310	552	3,790	1,350	.17
KA040AR0	4.000	4.500	4.186	4.314	4.367	1,490	595	4,300	1,470	.19
KA042AR0	4.250	4.750	4.436	4.564	4.615	1,580	616	4,550	1,530	.20
KA045AR0	4.500	5.000	4.686	4.814	4.865	1,660	637	4,810	1,580	.21
KA047AR0	4.750	5.250	4.936	5.064	5.115	1,750	657	5,060	1,640	.22
KA050AR0	5.000	5.500	5.186	5.314	5.365	1,840	676	5,310	1,690	.23
KA055AR0	5.500	6.000	5.686	5.814	5.863	2,020	715	5,820	1,800	.25
KA060AR0	6.000	6.500	6.186	6.314	6.363	2,190	752	6,320	1,900	.28
KA065AR0	6.500	7.000	6.686	6.814	6.861	2,370	788	6,830	2,000	.30
KA070AR0	7.000	7.500	7.186	7.314	7.361	2,540	823	7,340	2,100	.32
KA075AR0	7.500	8.000	7.686	7.814	7.861	2,720	857	7,840	2,190	.34
KA080AR0	8.000	8.500	8.186	8.314	8.359	2,890	890	8,350	2,280	.36
*KA090AR0	9.000	9.500	9.186	9.314	9.357	3,240	954	9,360	2,470	.41
KA100AR0	10.000	10.500	10.186	10.314	10.355	3,590	1,014	10,370	2,640	.45
*KA110AR0	11.000	11.500	11.186	11.314	11.353	3,940	1,072	11,380	2,810	.50
*KA120AR0	12.000	12.500	12.186	12.314	12.349	4,290	1,128	12,390	2,970	.54

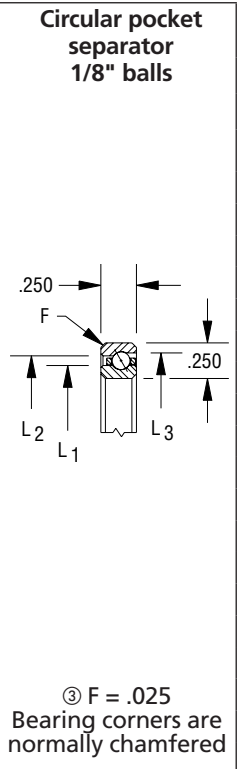

① Capacities listed are not simultaneous. For combined loading see discussion of Bearing Selection and Load Analysis. Dynamic capacities are based upon 1 million revolutions of L10 life. Published capacities do not apply to hybrid series bearings P, X, and Y - contact KAYDON product engineering for values.
 ② Static capacities are non-brinell limits based on rigid support from the shaft and housing.
 ③ "F" is the maximum shaft or housing fillet radius the bearing corners will clear.
 * Contact KAYDON for lead time and minimum purchase requirement.

TYPE A – OPEN REALI-SLIM® BEARINGS, ANGULAR CONTACT

Section 2 – Selection Tables

KB SERIES										
KAYDON Bearing Number	Dimensions in Inches					Capacities in Pounds ^①				Approx. Weight in Pounds
	Bore	Outside Dia.	Land Dia. L ₁	Land Dia. L ₂	C'Bore Dia. L ₃	Radial		Thrust		
						Static ^②	Dyn.	Static ^②	Dyn.	
KB020AR0	2.000	2.625	2.231	2.393	2.464	1,090	601	3,150	1,380	.15
KB025AR0	2.500	3.125	2.731	2.893	2.964	1,340	675	3,860	1,590	.19
KB030AR0	3.000	3.625	3.231	3.393	3.462	1,550	734	4,470	1,750	.22
KB035AR0	3.500	4.125	3.731	3.893	3.962	1,790	801	5,180	1,930	.27
KB040AR0	4.000	4.625	4.231	4.393	4.460	2,040	865	5,890	2,100	.30
KB042AR0	4.250	4.875	4.481	4.643	4.710	2,150	891	6,200	2,170	.31
KB045AR0	4.500	5.125	4.731	4.893	4.960	2,250	917	6,500	2,240	.34
*KB047AR0	4.750	5.375	4.981	5.143	5.210	2,390	951	6,910	2,340	.35
*KB050AR0	5.000	5.625	5.231	5.393	5.460	2,500	976	7,210	2,410	.37
KB055AR0	5.500	6.125	5.731	5.893	5.958	2,740	1,033	7,920	2,560	.40
KB060AR0	6.000	6.625	6.231	6.393	6.458	2,990	1,088	8,630	2,710	.44
*KB065AR0	6.500	7.125	6.731	6.893	6.958	3,200	1,132	9,240	2,840	.47
*KB070AR0	7.000	7.625	7.231	7.393	7.456	3,450	1,184	9,960	2,980	.50
*KB075AR0	7.500	8.125	7.731	7.893	7.955	3,700	1,235	10,670	3,120	.54
*KB080AR0	8.000	8.625	8.231	8.393	8.453	3,940	1,284	11,380	3,260	.57
KB090AR0	9.000	9.625	9.231	9.393	9.451	4,400	1,370	12,700	3,510	.64
*KB100AR0	10.000	10.625	10.231	10.393	10.449	4,890	1,461	14,120	3,760	.71
*KB110AR0	11.000	11.625	11.231	11.393	11.447	5,350	1,540	15,440	4,000	.78
*KB120AR0	12.000	12.625	12.231	12.393	12.445	5,840	1,623	16,860	4,240	.85
*KB140AR0	14.000	14.625	14.231	14.393	14.439	6,760	1,767	19,500	4,670	.98
*KB160AR0	16.000	16.625	16.231	16.393	16.433	7,710	1,907	22,250	5,100	1.12
*KB180AR0	18.000	18.625	18.231	18.393	18.425	8,660	2,038	24,990	5,510	1.26
*KB200AR0	20.000	20.625	20.231	20.393	20.416	9,610	2,162	27,730	5,900	1.40

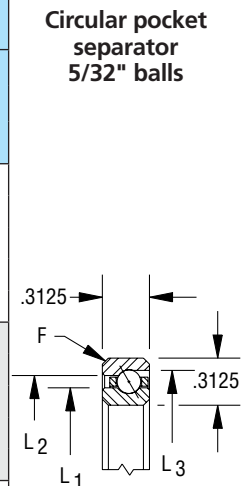

③ F = .040
Bearing corners are normally chamfered

① Capacities listed are not simultaneous. For combined loading see discussion of Bearing Selection and Load Analysis. Dynamic capacities are based upon 1 million revolutions of L10 life. Published capacities do not apply to hybrid series bearings P, X, and Y - contact KAYDON product engineering for values.
 ② Static capacities are non-brinell limits based on rigid support from the shaft and housing.
 ③ "F" is the maximum shaft or housing fillet radius the bearing corners will clear.
 * Contact KAYDON for lead time and minimum purchase requirement.

CONTACT KAYDON AT—
 KAYDON Corporation • Muskegon, Michigan 49443
 Telephone: 231/755-3741 • Fax: 231/759-4102
NEED SERVICE FAST?
1-800-514-3066
 Website: www.kaydonbearings.com

TYPE A – OPEN REALI-SLIM® BEARINGS, ANGULAR CONTACT

KC SERIES											Circular pocket separator 3/16" balls
KAYDON Bearing Number	Dimensions in Inches					Capacities in Pounds ^①				Approx. Weight in Pounds	
	Bore	Outside Dia.	Land Dia. L ₁	Land Dia. L ₂	C'Bore Dia. L ₃	Radial		Thrust			
						Static ^②	Dyn.	Static ^②	Dyn.		
KC040AR0	4.000	4.750	4.277	4.473	4.554	2,550	1,153	7,360	2,770	.44	
*KC042AR0	4.250	5.000	4.527	4.723	4.804	2,710	1,194	7,820	2,880	.46	
KC045AR0	4.500	5.250	4.777	4.973	5.052	2,860	1,234	8,270	2,990	.49	
KC047AR0	4.750	5.500	5.027	5.223	5.302	3,020	1,274	8,720	3,100	.51	
KC050AR0	5.000	5.750	5.277	5.473	5.552	3,180	1,313	9,170	3,200	.54	
KC055AR0	5.500	6.250	5.777	5.973	6.052	3,440	1,374	9,920	3,370	.58	
KC060AR0	6.000	6.750	6.277	6.473	6.550	3,750	1,448	10,820	3,580	.64	
*KC065AR0	6.500	7.250	6.777	6.973	7.050	4,060	1,519	11,720	3,770	.68	
KC070AR0	7.000	7.750	7.277	7.473	7.550	4,320	1,575	12,470	3,930	.74	
*KC075AR0	7.500	8.250	7.777	7.973	8.048	4,630	1,642	13,380	4,120	.78	
KC080AR0	8.000	8.750	8.277	8.473	8.548	4,950	1,708	14,280	4,300	.84	
*KC090AR0	9.000	9.750	9.277	9.473	9.546	5,520	1,822	15,930	4,630	.98	
*KC100AR0	10.000	10.750	10.277	10.473	10.544	6,140	1,942	17,730	4,970	1.04	
*KC110AR0	11.000	11.750	11.277	11.473	11.542	6,720	2,047	19,390	5,280	1.14	
*KC120AR0	12.000	12.750	12.277	12.473	12.540	7,290	2,147	21,040	5,570	1.23	
*KC140AR0	14.000	14.750	14.277	14.473	14.535	8,490	2,347	24,500	6,170	1.43	
*KC160AR0	16.000	16.750	16.277	16.473	16.529	9,680	2,533	27,950	6,730	1.63	
*KC180AR0	18.000	18.750	18.277	18.473	18.523	10,880	2,707	31,410	7,280	1.83	
*KC200AR0	20.000	20.750	20.277	20.473	20.517	12,030	2,863	34,720	7,780	2.03	
*KC250AR0	25.000	25.750	25.277	25.473	25.500	14,900	3,233	43,280	9,010	2.52	
*KC300AR0	30.000	30.750	30.277	30.473	30.484	17,960	3,561	51,850	10,160	3.02	

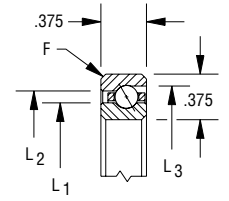

③ F = .040
Bearing corners are normally chamfered

KD SERIES											Circular pocket separator 1/4" balls
KAYDON Bearing Number	Dimensions in Inches					Capacities in Pounds ^①				Approx. Weight in Pounds	
	Bore	Outside Dia.	Land Dia. L ₁	Land Dia. L ₂	C'Bore Dia. L ₃	Radial		Thrust			
						Static ^②	Dyn.	Static ^②	Dyn.		
KD040AR0	4.000	5.000	4.370	4.630	4.741	3,550	1,819	10,260	4,260	.80	
KD042AR0	4.250	5.250	4.620	4.880	4.991	3,750	1,876	10,830	4,420	.84	
KD045AR0	4.500	5.500	4.870	5.130	5.241	3,950	1,931	11,400	4,570	.88	
KD047AR0	4.750	5.750	5.120	5.380	5.490	4,150	1,986	11,970	4,720	.93	
KD050AR0	5.000	6.000	5.370	5.630	5.740	4,340	2,040	12,540	4,870	.98	
KD055AR0	5.500	6.500	5.870	6.130	6.238	4,740	2,145	13,680	5,160	1.06	
KD060AR0	6.000	7.000	6.370	6.630	6.738	5,130	2,247	14,820	5,440	1.15	
KD065AR0	6.500	7.500	6.870	7.130	7.236	5,530	2,346	15,960	5,720	1.24	
KD070AR0	7.000	8.000	7.370	7.630	7.736	5,920	2,442	17,100	5,990	1.33	
KD075AR0	7.500	8.500	7.870	8.130	8.236	6,320	2,536	18,240	6,250	1.42	
KD080AR0	8.000	9.000	8.370	8.630	8.734	6,710	2,627	19,380	6,510	1.52	
KD090AR0	9.000	10.000	9.370	9.630	9.732	7,500	2,803	21,660	7,010	1.69	
*KD100AR0	10.000	11.000	10.370	10.630	10.732	8,290	2,972	23,940	7,500	1.87	
*KD110AR0	11.000	12.000	11.370	11.630	11.730	9,080	3,133	26,220	7,960	2.05	
KD120AR0	12.000	13.000	12.370	12.630	12.728	9,870	3,288	28,500	8,420	2.23	
*KD140AR0	14.000	15.000	14.370	14.630	14.724	11,450	3,582	33,060	9,290	2.57	
*KD160AR0	16.000	17.000	16.370	16.630	16.718	13,030	3,856	37,620	10,130	2.93	
*KD180AR0	18.000	19.000	18.370	18.630	18.712	14,610	4,113	42,180	10,930	3.29	
*KD200AR0	20.000	21.000	20.370	20.630	20.705	16,190	4,356	46,740	11,710	3.65	
*KD210AR0	21.000	22.000	21.370	21.630	21.700	16,981	4,472	49,020	12,086	3.83	
*KD250AR0	25.000	26.000	25.370	25.630	25.688	20,140	4,908	58,140	13,540	4.54	
*KD300AR0	30.000	31.000	30.370	30.630	30.672	24,090	5,397	69,540	15,260	5.44	

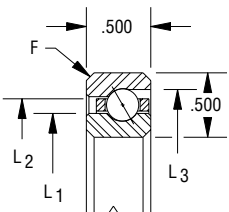

③ F = .060
Bearing corners are normally chamfered

① Capacities listed are not simultaneous. For combined loading see discussion of Bearing Selection and Load Analysis. Dynamic capacities are based upon 1 million revolutions of L10 life. Published capacities do not apply to hybrid series bearings P, X, and Y - contact KAYDON product engineering for values.
 ② Static capacities are non-brinell limits based on rigid support from the shaft and housing.
 ③ "F" is the maximum shaft or housing fillet radius the bearing corners will clear.
 * Contact KAYDON for lead time and minimum purchase requirement.

TYPE A – OPEN REALI-SLIM® BEARINGS, ANGULAR CONTACT

KF SERIES										
KAYDON Bearing Number	Dimensions in Inches					Capacities in Pounds ^①				Approx. Weight in Pounds
	Bore	Outside Dia.	Land Dia. L ₁	Land Dia. L ₂	C'Bore Dia. L ₃	Radial		Thrust		
						Static ^②	Dyn.	Static ^②	Dyn.	
*KF040AR0	4.000	5.500	4.555	4.945	5.115	6,350	3,736	18,340	8,420	1.92
*KF042AR0	4.250	5.750	4.805	5.195	5.365	6,600	3,805	19,050	8,630	2.04
*KF045AR0	4.500	6.000	5.055	5.445	5.615	7,090	3,966	20,460	9,050	2.14
KF047AR0	4.750	6.250	5.305	5.695	5.865	7,330	4,034	21,160	9,260	2.26
*KF050AR0	5.000	6.500	5.555	5.945	6.115	7,570	4,101	21,870	9,460	2.37
KF055AR0	5.500	7.000	6.055	6.445	6.613	8,310	4,319	23,980	10,060	2.59
KF060AR0	6.000	7.500	6.555	6.945	7.113	9,040	4,530	26,100	10,650	2.72
KF065AR0	6.500	8.000	7.055	7.445	7.613	9,770	4,734	28,220	11,220	2.94
*KF070AR0	7.000	8.500	7.555	7.945	8.113	10,510	4,932	30,330	11,770	3.16
KF075AR0	7.500	9.000	8.055	8.445	8.610	11,000	5,052	31,740	12,130	3.39
KF080AR0	8.000	9.500	8.555	8.945	9.110	11,730	5,242	33,860	12,670	3.61
KF090AR0	9.000	10.500	9.555	9.945	10.108	13,190	5,608	38,090	13,700	3.95
KF100AR0	10.000	11.500	10.555	10.945	11.106	14,420	5,890	41,620	14,530	4.40
*KF110AR0	11.000	12.500	11.555	11.945	12.106	15,880	6,227	45,850	15,500	4.75
KF120AR0	12.000	13.500	12.555	12.945	13.104	17,100	6,487	49,380	16,290	5.20
*KF140AR0	14.000	15.500	14.555	14.945	15.102	19,790	7,043	57,140	17,950	5.76
*KF160AR0	16.000	17.500	16.555	16.945	17.098	22,480	7,563	64,890	19,540	6.78
*KF180AR0	18.000	19.500	18.555	18.945	19.096	25,410	8,103	73,360	21,210	7.67
*KF200AR0	20.000	21.500	20.555	20.945	21.092	28,100	8,562	81,120	22,680	8.47
*KF250AR0	25.000	26.500	25.555	25.945	26.085	34,700	9,585	100,200	26,100	10.50
*KF300AR0	30.000	31.500	30.555	30.945	31.075	41,540	10,533	119,900	29,430	12.50
*KF350AR0	35.000	36.500	35.555	35.945	36.064	48,380	11,382	139,700	32,580	14.60
*KF400AR0	40.000	41.500	40.555	40.945	41.054	55,220	12,147	159,400	35,580	16.60

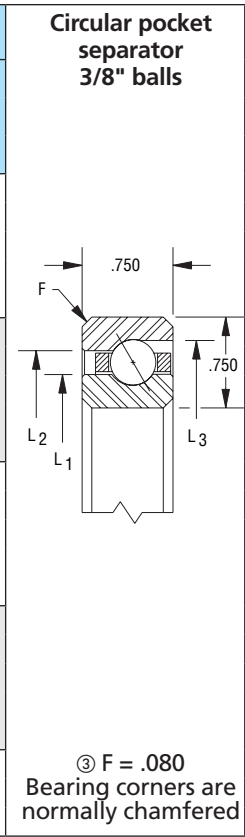

KG SERIES										
KAYDON Bearing Number	Dimensions in Inches					Capacities in Pounds ^①				Approx. Weight in Pounds
	Bore	Outside Dia.	Land Dia. L ₁	Land Dia. L ₂	C'Bore Dia. L ₃	Radial		Thrust		
						Static ^②	Dyn.	Static ^②	Dyn.	
*KG040AR0	4.000	6.000	4.742	5.258	5.491	9,480	6,281	27,360	13,630	3.61
*KG042AR0	4.250	6.250	4.992	5.508	5.741	9,950	6,438	28,730	14,090	3.83
*KG045AR0	4.500	6.500	5.242	5.758	5.989	10,430	6,562	30,100	14,530	3.95
*KG047AR0	4.750	6.750	5.492	6.008	6.239	10,900	6,745	31,460	14,970	4.17
*KG050AR0	5.000	7.000	5.742	6.258	6.489	11,370	6,897	32,830	15,400	4.42
*KG055AR0	5.500	7.500	6.242	6.758	6.989	12,320	7,192	35,570	16,240	4.73
KG060AR0	6.000	8.000	6.742	7.258	7.489	13,270	7,480	38,300	17,060	5.07
*KG065AR0	6.500	8.500	7.242	7.758	7.987	14,220	7,761	41,040	17,870	5.41
*KG070AR0	7.000	9.000	7.742	8.258	8.487	15,160	8,035	43,780	18,650	5.87
*KG075AR0	7.500	9.500	8.242	8.758	8.987	16,110	8,303	46,510	19,420	6.20
KG080AR0	8.000	10.000	8.742	9.258	9.485	17,060	8,566	49,250	20,180	6.54
KG090AR0	9.000	11.000	9.742	10.258	10.485	18,960	9,073	54,720	21,640	7.22
KG100AR0	10.000	12.000	10.742	11.258	11.483	20,850	9,561	60,190	23,060	8.00
*KG110AR0	11.000	13.000	11.742	12.258	12.481	22,750	10,027	65,660	24,440	8.68
KG120AR0	12.000	14.000	12.742	13.258	13.481	24,640	10,481	71,140	25,780	9.47
KG140AR0	14.000	16.000	14.742	15.258	15.478	28,430	11,338	82,080	28,360	10.90
KG160AR0	16.000	18.000	16.742	17.258	17.474	32,220	12,142	93,020	30,830	12.40
KG180AR0	18.000	20.000	18.742	19.258	19.472	36,020	12,898	104,000	33,200	13.80
KG200AR0	20.000	22.000	20.742	21.258	21.468	39,810	13,612	114,900	35,490	15.20
*KG220AR0	22.000	24.000	22.742	23.258	23.468	43,598	14,290	125,856	37,712	16.63
*KG250AR0	25.000	27.000	25.742	26.258	26.461	49,280	15,239	142,300	40,920	18.80
*KG300AR0	30.000	32.000	30.742	31.258	31.451	58,760	16,687	169,600	46,020	22.50
KG350AR0	35.000	37.000	35.742	36.258	36.440	68,240	17,982	197,000	50,840	26.20
*KG400AR0	40.000	42.000	40.742	41.258	41.430	77,720	19,153	224,400	55,440	29.80

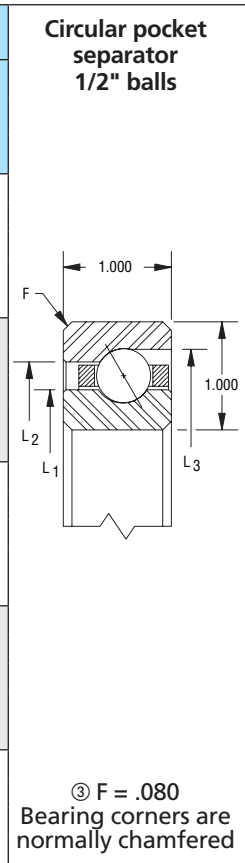

① Capacities listed are not simultaneous. For combined loading see discussion of Bearing Selection and Load Analysis. Dynamic capacities are based upon 1 million revolutions of L10 life. Published capacities do not apply to hybrid series bearings P, X, and Y - contact KAYDON product engineering for values.
 ② Static capacities are non-brinell limits based on rigid support from the shaft and housing.
 ③ "F" is the maximum shaft or housing fillet radius the bearing corners will clear.
 * Contact KAYDON for lead time and minimum purchase requirement.

Open REALI-SLIM® Bearing Selections

Type C

Radial Contact

A Conrad assembled bearing designed primarily for application of radial load—deep ball grooves also permit application of thrust load in either direction – often used in conjunction with another bearing.

KAA SERIES							
KAYDON Bearing Number	Dimensions in Inches				Radial Capacities in Pounds ^①		Approx. Weight in Pounds
	Bore	Outside Dia.	Land Dia. L ₁	Land Dia. L ₂	Static ^②	Dyn.	
KAA10CLO	1.000	1.375	1.140	1.235	290	188	.026
KAA15CLO	1.500	1.875	1.640	1.735	400	225	.039
KAA17CLO	1.750	2.125	1.890	1.985	460	242	.045

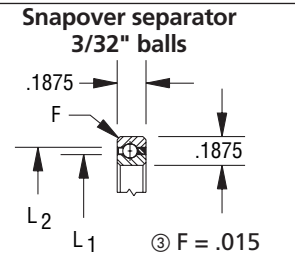

KA SERIES							
KAYDON Bearing Number	Dimensions in Inches				Radial Capacities in Pounds ^①		Approx. Weight in Pounds
	Bore	Outside Dia.	Land Dia. L ₁	Land Dia. L ₂	Static ^②	Dyn.	
KA020CP0	2.000	2.500	2.186	2.314	680	393	.10
KA025CP0	2.500	3.000	2.686	2.814	830	442	.13
KA030CP0	3.000	3.500	3.186	3.314	990	487	.15
KA035CP0	3.500	4.000	3.686	3.814	1,140	530	.18
KA040CP0	4.000	4.500	4.186	4.314	1,290	571	.19
KA042CP0	4.250	4.750	4.436	4.564	1,370	591	.20
KA045CP0	4.500	5.000	4.686	4.814	1,440	610	.22
KA047CP0	4.750	5.250	4.936	5.064	1,520	629	.23
KA050CP0	5.000	5.500	5.186	5.314	1,590	648	.24
KA055CP0	5.500	6.000	5.686	5.814	1,750	685	.25
KA060CP0	6.000	6.500	6.186	6.314	1,900	720	.28
KA065CP0	6.500	7.000	6.686	6.814	2,050	754	.30
KA070CP0	7.000	7.500	7.186	7.314	2,200	787	.31
KA075CP0	7.500	8.000	7.686	7.814	2,350	820	.34
KA080CP0	8.000	8.500	8.186	8.314	2,500	851	.38
KA090CP0	9.000	9.500	9.186	9.314	2,810	912	.44
KA100CP0	10.000	10.500	10.186	10.314	3,110	969	.50
*KA110CP0	11.000	11.500	11.186	11.314	3,410	1,025	.52
KA120CP0	12.000	12.500	12.186	12.314	3,720	1,078	.56

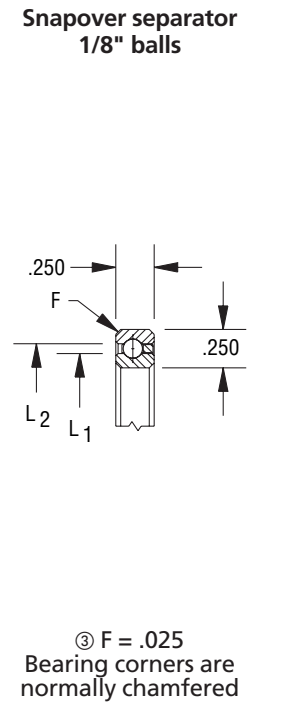

① Capacities listed are not simultaneous. For combined loading see discussion of Bearing Selection and Load Analysis. Dynamic capacities are based upon 1 million revolutions of L10 life. Published capacities do not apply to hybrid series bearings P, X, and Y - contact KAYDON product engineering for values.

② Static capacities are non-brinell limits based on rigid support from the shaft and housing.

③ "F" is the maximum shaft or housing fillet radius the bearing corners will clear.

* Contact KAYDON for lead time and minimum purchase requirement.

TYPE C – OPEN REALI-SLIM® BEARINGS, RADIAL CONTACT

Section 2—Selection Tables

KB SERIES							
KAYDON Bearing Number	Dimensions in Inches				Radial Capacities in Pounds ^①		Approx. Weight in Pounds
	Bore	Outside Dia.	Land Dia. L ₁	Land Dia. L ₂	Static ^②	Dyn.	
KB020CP0	2.000	2.625	2.231	2.393	930	577	.16
KB025CP0	2.500	3.125	2.731	2.893	1,140	644	.20
KB030CP0	3.000	3.625	3.231	3.393	1,340	707	.24
KB035CP0	3.500	4.125	3.731	3.893	1,540	767	.27
KB040CP0	4.000	4.625	4.231	4.393	1,750	825	.30
KB042CP0	4.250	4.875	4.481	4.643	1,830	846	.31
KB045CP0	4.500	5.125	4.731	4.893	1,950	880	.33
*KB047CP0	4.750	5.375	4.981	5.143	2,030	901	.34
KB050CP0	5.000	5.625	5.231	5.393	2,150	933	.38
*KB055CP0	5.500	6.125	5.731	5.893	2,360	984	.41
KB060CP0	6.000	6.625	6.231	6.393	2,560	1,034	.44
KB065CP0	6.500	7.125	6.731	6.893	2,760	1,082	.47
*KB070CP0	7.000	7.625	7.231	7.393	2,970	1,129	.50
*KB075CP0	7.500	8.125	7.731	7.893	3,170	1,175	.53
KB080CP0	8.000	8.625	8.231	8.393	3,370	1,219	.57
*KB090CP0	9.000	9.625	9.231	9.393	3,780	1,304	.66
*KB100CP0	10.000	10.625	10.231	10.393	4,190	1,386	.73
*KB110CP0	11.000	11.625	11.231	11.393	4,590	1,464	.75
*KB120CP0	12.000	12.625	12.231	12.393	5,000	1,539	.83
*KB140CP0	14.000	14.625	14.231	14.393	5,810	1,680	1.05
*KB160CP0	16.000	16.625	16.231	16.393	6,620	1,812	1.20
*KB180CP0	18.000	18.625	18.231	18.393	7,440	1,936	1.35
*KB200CP0	20.000	20.625	20.231	20.393	8,250	2,053	1.50

Snapover separator
5/32" balls

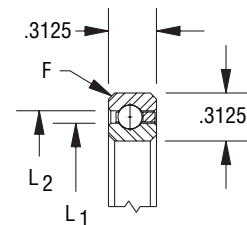

③ F = .040
Bearing corners are normally chamfered

- ① Capacities listed are not simultaneous. For combined loading see discussion of Bearing Selection and Load Analysis. Dynamic capacities are based upon 1 million revolutions of L10 life. Published capacities do not apply to hybrid series bearings P, X, and Y - contact KAYDON product engineering for values.
- ② Static capacities are non-brinell limits based on rigid support from the shaft and housing.
- ③ "F" is the maximum shaft or housing fillet radius the bearing corners will clear.
- * Contact KAYDON for lead time and minimum purchase requirement.

CONTACT KAYDON AT—
KAYDON Corporation • Muskegon, Michigan 49443
Telephone: 231/755-3741 • Fax: 231/759-4102

NEED SERVICE FAST?
1-800-514-3066
Website: www.kaydonbearings.com

TYPE C – OPEN REALI-SLIM® BEARINGS, RADIAL CONTACT

KC SERIES								Snapover separator 3/16" balls
KAYDON Bearing Number	Dimensions in Inches				Radial Capacities in Pounds ^①		Approx. Weight in Pounds	
	Bore	Outside Dia.	Land Dia. L ₁	Land Dia. L ₂	Static ^②	Dyn.		
KC040CP0	4.000	4.750	4.277	4.473	2,100	1,073	.45	
KC042CP0	4.250	5.000	4.527	4.723	2,220	1,108	.47	
KC045CP0	4.500	5.250	4.777	4.973	2,340	1,143	.48	
KC047CP0	4.750	5.500	5.027	5.223	2,460	1,176	.50	
KC050CP0	5.000	5.750	5.277	5.473	2,590	1,209	.58	
KC055CP0	5.500	6.250	5.777	5.973	2,830	1,274	.59	
KC060CP0	6.000	6.750	6.277	6.473	3,070	1,337	.63	
KC065CP0	6.500	7.250	6.777	6.973	3,310	1,397	.68	
KC070CP0	7.000	7.750	7.277	7.473	3,550	1,457	.73	
KC075CP0	7.500	8.250	7.777	7.973	3,790	1,514	.78	
KC080CP0	8.000	8.750	8.277	8.473	4,030	1,570	.84	
KC090CP0	9.000	9.750	9.277	9.473	4,510	1,678	.94	
KC100CP0	10.000	10.750	10.277	10.473	4,990	1,781	1.06	
*KC110CP0	11.000	11.750	11.277	11.473	5,470	1,879	1.16	
KC120CP0	12.000	12.750	12.277	12.473	5,950	1,974	1.25	
KC140CP0	14.000	14.750	14.277	14.473	6,910	2,154	1.52	
KC160CP0	16.000	16.750	16.277	16.473	7,880	2,321	1.73	
*KC180CP0	18.000	18.750	18.277	18.473	8,840	2,478	1.94	
*KC200CP0	20.000	20.750	20.277	20.473	9,800	2,626	2.16	
*KC250CP0	25.000	25.750	25.277	25.473	12,200	2,962	2.69	
*KC300CP0	30.000	30.750	30.277	30.473	14,610	3,260	3.21	

③ F = .040
Bearing corners are normally chamfered

KD SERIES								Snapover separator 1/4" balls
KAYDON Bearing Number	Dimensions in Inches				Radial Capacities in Pounds ^①		Approx. Weight in Pounds	
	Bore	Outside Dia.	Land Dia. L ₁	Land Dia. L ₂	Static ^②	Dyn.		
KD040CP0	4.000	5.000	4.370	4.630	3,080	1,755	.78	
KD042CP0	4.250	5.250	4.620	4.880	3,190	1,787	.83	
KD045CP0	4.500	5.500	4.870	5.130	3,420	1,861	.88	
KD047CP0	4.750	5.750	5.120	5.380	3,530	1,892	.94	
KD050CP0	5.000	6.000	5.370	5.630	3,760	1,964	1.00	
KD055CP0	5.500	6.500	5.870	6.130	4,100	2,063	1.06	
KD060CP0	6.000	7.000	6.370	6.630	4,450	2,160	1.16	
KD065CP0	6.500	7.500	6.870	7.130	4,790	2,254	1.22	
KD070CP0	7.000	8.000	7.370	7.630	5,130	2,345	1.31	
KD075CP0	7.500	8.500	7.870	8.130	5,470	2,434	1.41	
KD080CP0	8.000	9.000	8.370	8.630	5,810	2,520	1.53	
KD090CP0	9.000	10.000	9.370	9.630	6,500	2,688	1.72	
KD100CP0	10.000	11.000	10.370	10.630	7,180	2,847	1.88	
KD110CP0	11.000	12.000	11.370	11.630	7,870	3,000	2.06	
KD120CP0	12.000	13.000	12.370	12.630	8,550	3,148	2.25	
KD140CP0	14.000	15.000	14.370	14.630	9,920	3,427	2.73	
*KD160CP0	16.000	17.000	16.370	16.630	11,290	3,688	3.10	
*KD180CP0	18.000	19.000	18.370	18.630	12,650	3,933	3.48	
*KD200CP0	20.000	21.000	20.370	20.630	14,020	4,164	3.85	
*KD210CP0	21.000	22.000	21.370	21.630	14,706	4,274	4.04	
*KD250CP0	25.000	26.000	25.370	25.630	17,440	4,689	4.79	
*KD300CP0	30.000	31.000	30.370	30.360	20,860	5,153	5.73	

③ F = .060
Bearing corners are normally chamfered

① Capacities listed are not simultaneous. For combined loading see discussion of Bearing Selection and Load Analysis. Dynamic capacities are based upon 1 million revolutions of L10 life. Published capacities do not apply to hybrid series bearings P, X, and Y - contact KAYDON product engineering for values.
 ② Static capacities are non-brinell limits based on rigid support from the shaft and housing.
 ③ "F" is the maximum shaft or housing fillet radius the bearing corners will clear.
 * Contact KAYDON for lead time and minimum purchase requirement.

TYPE C – OPEN REALI-SLIM® BEARINGS, RADIAL CONTACT

Section 2 – Selection Tables

KF SERIES							
KAYDON Bearing Number	Dimensions in Inches				Radial Capacities in Pounds ^①		Approx. Weight in Pounds
	Bore	Outside Dia.	Land Dia. L ₁	Land Dia. L ₂	Static ^②	Dyn.	
KF040CP0	4.000	5.500	4.555	4.945	5,360	3,559	1.9
KF042CP0	4.250	5.750	4.805	5.195	5,640	3,655	2.0
KF045CP0	4.500	6.000	5.055	5.445	5,930	3,750	2.1
KF047CP0	4.750	6.250	5.305	5.695	6,210	3,843	2.2
KF050CP0	5.000	6.500	5.555	5.945	6,490	3,936	2.3
KF055CP0	5.500	7.000	6.055	6.445	7,050	4,116	2.5
KF060CP0	6.000	7.500	6.555	6.945	7,620	4,291	2.7
KF065CP0	6.500	8.000	7.055	7.445	8,180	4,461	2.9
KF070CP0	7.000	8.500	7.555	7.945	8,750	4,628	3.2
KF075CP0	7.500	9.000	8.055	8.445	9,310	4,791	3.4
KF080CP0	8.000	9.500	8.555	8.945	9,880	4,949	3.5
KF090CP0	9.000	10.500	9.555	9.945	11,000	5,256	3.9
KF100CP0	10.000	11.500	10.555	10.945	12,130	5,550	4.3
KF110CP0	11.000	12.500	11.555	11.945	13,260	5,833	4.8
KF120CP0	12.000	13.500	12.555	12.945	14,390	6,105	5.2
*KF140CP0	14.000	15.500	14.555	14.945	16,650	6,620	6.0
*KF160CP0	16.000	17.500	16.555	16.945	18,900	7,104	7.1
*KF180CP0	18.000	19.500	18.555	18.945	21,160	7,557	7.9
*KF200CP0	20.000	21.500	20.555	20.945	23,420	7,986	8.9
*KF250CP0	25.000	26.500	25.555	25.945	29,060	8,963	10.9
*KF300CP0	30.000	31.500	30.555	30.945	34,700	9,828	13.0
*KF350CP0	35.000	36.500	35.555	35.945	40,350	10,603	15.1
*KF400CP0	40.000	41.500	40.555	40.945	45,990	11,302	17.2

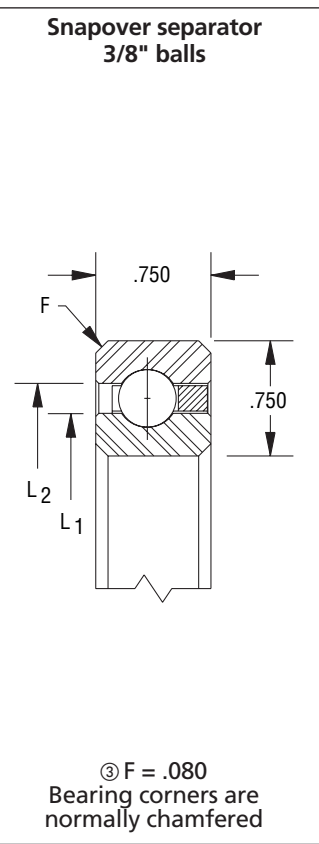

KG SERIES							
KAYDON Bearing Number	Dimensions in Inches				Radial Capacities in Pounds ^①		Approx. Weight in Pounds
	Bore	Outside Dia.	Land Dia. L ₁	Land Dia. L ₂	Static ^②	Dyn.	
*KG040CP0	4.000	6.000	4.742	5.258	8,210	6,115	3.6
*KG042CP0	4.250	6.250	4.992	5.508	8,210	6,061	3.8
*KG045CP0	4.500	6.500	5.242	5.758	8,760	6,277	4.0
*KG047CP0	4.750	6.750	5.492	6.008	9,300	6,487	4.1
KG050CP0	5.000	7.000	5.742	6.258	9,850	6,691	4.3
*KG055CP0	5.500	7.500	6.242	6.758	10,400	6,850	4.7
KG060CP0	6.000	8.000	6.742	7.258	11,490	7,241	5.1
KG065CP0	6.500	8.500	7.242	7.758	12,040	7,393	5.4
KG070CP0	7.000	9.000	7.742	8.258	13,130	7,764	5.8
KG075CP0	7.500	9.500	8.242	8.758	13,680	7,911	6.1
KG080CP0	8.000	10.000	8.742	9.258	14,770	8,265	6.5
KG090CP0	9.000	11.000	9.742	10.258	16,420	8,743	7.2
KG100CP0	10.000	12.000	10.742	11.258	18,060	9,204	7.9
KG110CP0	11.000	13.000	11.742	12.258	19,700	9,648	8.6
KG120CP0	12.000	14.000	12.742	13.258	21,340	10,074	9.3
KG140CP0	14.000	16.000	14.742	15.258	24,620	10,886	10.8
KG160CP0	16.000	18.000	16.742	17.258	27,910	11,648	12.3
KG180CP0	18.000	20.000	18.742	19.258	31,190	12,367	13.7
KG200CP0	20.000	22.000	20.742	21.258	34,470	13,044	15.8
*KG220CP0	22.000	24.000	22.742	23.258	37,757	13,685	16.8
KG250CP0	25.000	27.000	25.742	26.258	42,680	14,591	19.5
*KG300CP0	30.000	32.000	30.742	31.258	50,890	15,963	23.3
*KG350CP0	35.000	37.000	35.742	36.258	59,100	17,195	27.1
*KG400CP0	40.000	42.000	40.742	41.258	67,310	18,307	30.8

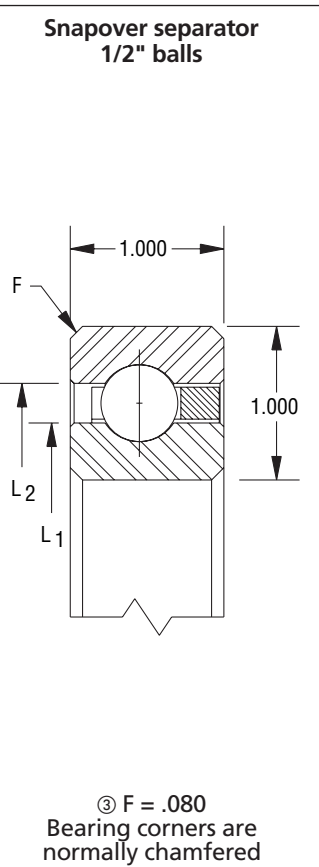

① Capacities listed are not simultaneous. For combined loading see discussion of Bearing Selection and Load Analysis. Dynamic capacities are based upon 1 million revolutions of L10 life. Published capacities do not apply to hybrid series bearings P, X, and Y - contact KAYDON product engineering for values.
 ② Static capacities are non-brinell limits based on rigid support from the shaft and housing.
 ③ "F" is the maximum shaft or housing fillet radius the bearing corners will clear.
 * Contact KAYDON for lead time and minimum purchase requirement.

Open REALI-SLIM® Bearing Selections

Type X

Four-Point Contact

A Conrad assembled bearing designed for applications involving multiple loads. Unique internal geometry permits application of radial load, thrust load in either direction, and moment load, individually or in any combination. A single four-point contact bearing may replace two bearings in many applications.

KAA SERIES											
KAYDON Bearing Number	Dimensions in Inches				Capacities ^①						Approx. Weight in Pounds
	Bore	Outside Dia.	Land Dia. L ₁	Land Dia. L ₂	Radial (lbs)		Thrust (lbs)		Moment (in-lbs)		
					Static ^②	Dyn.	Static ^②	Dyn.	Static ^②	Dyn.	
KAA10XL0	1.000	1.375	1.140	1.235	290	247	730	370	170	110	.026
KAA15XL0	1.500	1.875	1.640	1.735	400	296	1,000	460	340	187	.039
KAA17XL0	1.750	2.125	1.890	1.985	460	319	1,140	500	440	232	.045

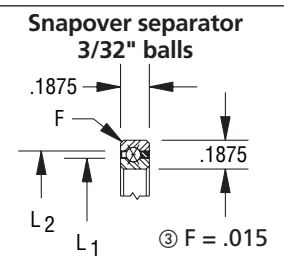

KA SERIES											
KAYDON Bearing Number	Dimensions in Inches				Capacities ^①						Approx. Weight in Pounds
	Bore	Outside Dia.	Land Dia. L ₁	Land Dia. L ₂	Radial (lbs)		Thrust (lbs)		Moment (in-lbs)		
					Static ^②	Dyn.	Static ^②	Dyn.	Static ^②	Dyn.	
KA020XP0	2.000	2.500	2.186	2.314	680	514	1,710	790	770	434	.10
KA025XP0	2.500	3.000	2.686	2.814	830	583	2,090	910	1,150	601	.13
KA030XP0	3.000	3.500	3.186	3.314	990	643	2,470	1,010	1,600	785	.15
KA035XP0	3.500	4.000	3.686	3.814	1,140	701	2,850	1,110	2,130	986	.18
KA040XP0	4.000	4.500	4.186	4.314	1,290	756	3,220	1,210	2,740	1,205	.19
KA042XP0	4.250	4.750	4.436	4.564	1,370	783	3,410	1,260	3,070	1,321	.20
KA045XP0	4.500	5.000	4.686	4.814	1,440	809	3,600	1,310	3,420	1,441	.22
KA047XP0	4.750	5.250	4.936	5.064	1,520	834	3,790	1,350	3,790	1,565	.23
KA050XP0	5.000	5.500	5.186	5.314	1,590	859	3,980	1,400	4,180	1,693	.24
KA055XP0	5.500	6.000	5.686	5.814	1,750	908	4,360	1,480	5,020	1,959	.25
KA060XP0	6.000	6.500	6.186	6.314	1,900	955	4,740	1,570	5,930	2,240	.28
KA065XP0	6.500	7.000	6.686	6.814	2,050	1,001	5,120	1,650	6,910	2,535	.30
KA070XP0	7.000	7.500	7.186	7.314	2,200	1,046	5,500	1,730	7,980	2,844	.31
KA075XP0	7.500	8.000	7.686	7.814	2,350	1,089	5,880	1,810	9,120	3,165	.34
KA080XP0	8.000	8.500	8.186	8.314	2,500	1,131	6,260	1,890	10,330	3,499	.38
KA090XP0	9.000	9.500	9.186	9.314	2,810	1,212	7,020	2,040	12,990	4,204	.44
KA100XP0	10.000	10.500	10.186	10.314	3,110	1,289	7,780	2,180	15,940	4,956	.50
*KA110XP0	11.000	11.500	11.186	11.314	3,410	1,362	8,540	2,320	19,210	5,750	.52
KA120XP0	12.000	12.500	12.186	12.314	3,720	1,433	9,300	2,450	22,770	6,587	.56

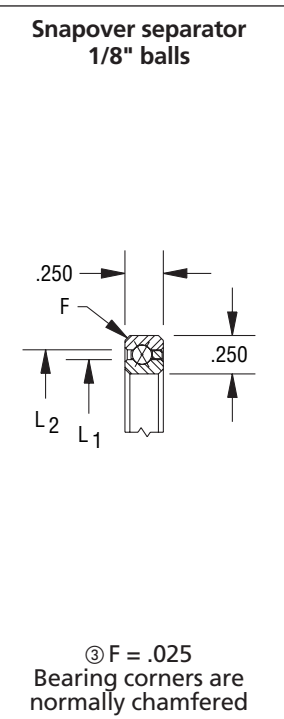

① Capacities listed are not simultaneous. For combined loading see discussion of Bearing Selection and Load Analysis. Dynamic capacities are based upon 1 million revolutions of L10 life. Published capacities do not apply to hybrid series bearings P, X, and Y - contact KAYDON product engineering for values.

② Static capacities are non-brinell limits based on rigid support from the shaft and housing.

③ "F" is the maximum shaft or housing fillet radius the bearing corners will clear.

* Contact KAYDON for lead time and minimum purchase requirement.

TYPE X – OPEN REALI-SLIM® BEARINGS, FOUR-POINT CONTACT

Section 2 – Selection Tables

KB SERIES											
KAYDON Bearing Number	Dimensions in Inches				Capacities ^①						Approx. Weight in Pounds
	Bore	Outside Dia.	Land Dia. L ₁	Land Dia. L ₂	Radial (lbs)		Thrust (lbs)		Moment (in-lbs)		
					Static ^②	Dyn.	Static ^②	Dyn.	Static ^②	Dyn.	
KB020XP0	2.000	2.625	2.231	2.393	930	758	2,340	1,130	1,080	658	.16
KB025XP0	2.500	3.125	2.731	2.893	1,140	848	2,840	1,290	1,600	895	.19
KB030XP0	3.000	3.625	3.231	3.393	1,340	933	3,350	1,440	2,220	1,159	.24
KB035XP0	3.500	4.125	3.731	3.893	1,540	1,014	3,860	1,590	2,940	1,450	.27
KB040XP0	4.000	4.625	4.231	4.393	1,750	1,091	4,370	1,720	3,770	1,764	.30
KB042XP0	4.250	4.875	4.481	4.643	1,830	1,120	4,570	1,780	4,170	1,917	.31
KB045XP0	4.500	5.125	4.731	4.893	1,950	1,165	4,880	1,850	4,690	2,103	.33
*KB047XP0	4.750	5.375	4.981	5.143	2,030	1,193	5,080	1,900	5,140	2,265	.34
KB050XP0	5.000	5.625	5.231	5.393	2,150	1,236	5,380	1,980	5,720	2,463	.38
KB055XP0	5.500	6.125	5.731	5.893	2,360	1,304	5,890	2,100	6,850	2,844	.41
KB060XP0	6.000	6.625	6.231	6.393	2,560	1,371	6,400	2,220	8,080	3,247	.44
KB065XP0	6.500	7.125	6.731	6.893	2,760	1,435	6,910	2,340	9,410	3,668	.47
*KB070XP0	7.000	7.625	7.231	7.393	2,970	1,498	7,420	2,450	10,850	4,109	.50
*KB075XP0	7.500	8.125	7.731	7.893	3,170	1,559	7,920	2,560	12,380	4,568	.53
KB080XP0	8.000	8.625	8.231	8.393	3,370	1,618	8,430	2,670	14,020	5,045	.57
KB090XP0	9.000	9.625	9.231	9.393	3,780	1,732	9,450	2,880	17,600	6,050	.66
*KB100XP0	10.000	10.625	10.231	10.393	4,190	1,841	10,460	3,080	21,580	7,121	.73
*KB110XP0	11.000	11.625	11.231	11.393	4,590	1,945	11,480	3,280	25,970	8,254	.75
*KB120XP0	12.000	12.625	12.231	12.393	5,000	2,045	12,500	3,470	30,770	9,446	.83
*KB140XP0	14.000	14.625	14.231	14.393	5,810	2,234	14,530	3,840	41,580	11,994	1.05
KB160XP0	16.000	16.625	16.231	16.393	6,620	2,410	16,560	4,190	54,020	14,750	1.20
*KB180XP0	18.000	18.625	18.231	18.393	7,440	2,576	18,590	4,520	68,090	17,694	1.35
*KB200XP0	20.000	20.625	20.231	20.393	8,250	2,731	20,620	4,850	83,780	20,813	1.50

Snapover separator
5/32" balls

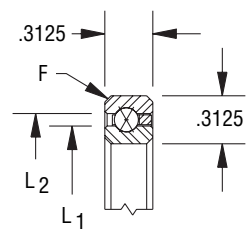

③ F = .040
Bearing corners are normally chamfered

① Capacities listed are not simultaneous. For combined loading see discussion of Bearing Selection and Load Analysis. Dynamic capacities are based upon 1 million revolutions of L10 life. Published capacities do not apply to hybrid series bearings P, X, and Y - contact KAYDON product engineering for values.
 ② Static capacities are non-brinell limits based on rigid support from the shaft and housing.
 ③ "F" is the maximum shaft or housing fillet radius the bearing corners will clear.
 * Contact KAYDON for lead time and minimum purchase requirement.

CONTACT KAYDON AT—
 KAYDON Corporation • Muskegon, Michigan 49443
 Telephone: 231/755-3741 • Fax: 231/759-4102

NEED SERVICE FAST?
1-800-514-3066
 Website: www.kaydonbearings.com

TYPE X – OPEN REALI-SLIM® BEARINGS, FOUR-POINT CONTACT

KC SERIES											
KAYDON Bearing Number	Dimensions in Inches				Capacities ^①						Approx. Weight in Pounds
	Bore	Outside Dia.	Land Dia. L ₁	Land Dia. L ₂	Radial (lbs)		Thrust (lbs)		Moment (in-lbs)		
					Static ^②	Dyn.	Static ^②	Dyn.	Static ^②	Dyn.	
KC040XP0	4.000	4.750	4.277	4.473	2,100	1,417	5,260	2,210	4,600	2,326	.45
*KC042XP0	4.250	5.000	4.527	4.723	2,220	1,464	5,560	2,290	5,140	2,541	.47
KC045XP0	4.500	5.250	4.777	4.973	2,340	1,510	5,860	2,380	5,710	2,762	.48
KC047XP0	4.750	5.500	5.027	5.223	2,460	1,556	6,160	2,460	6,320	2,991	.50
KC050XP0	5.000	5.750	5.277	5.473	2,590	1,600	6,460	2,540	6,950	3,226	.58
KC055XP0	5.500	6.250	5.777	5.973	2,830	1,687	7,060	2,690	8,300	3,717	.59
KC060XP0	6.000	6.750	6.277	6.473	3,070	1,770	7,660	2,840	9,770	4,234	.63
KC065XP0	6.500	7.250	6.777	6.973	3,310	1,851	8,270	2,990	11,370	4,775	.68
KC070XP0	7.000	7.750	7.277	7.473	3,550	1,931	8,870	3,130	13,080	5,341	.73
*KC075XP0	7.500	8.250	7.777	7.973	3,790	2,007	9,470	3,270	14,910	5,930	.78
KC080XP0	8.000	8.750	8.277	8.473	4,030	2,082	10,070	3,410	16,870	6,542	.84
KC090XP0	9.000	9.750	9.277	9.473	4,510	2,226	11,270	3,670	21,130	7,830	.94
KC100XP0	10.000	10.750	10.277	10.473	4,990	2,364	12,470	3,930	25,880	9,201	1.06
KC110XP0	11.000	11.750	11.277	11.473	5,470	2,496	13,680	4,180	31,110	10,651	1.16
KC120XP0	12.000	12.750	12.277	12.473	5,950	2,622	14,880	4,420	36,830	12,174	1.25
KC140XP0	14.000	14.750	14.277	14.473	6,910	2,862	17,280	4,890	49,690	15,434	1.52
KC160XP0	16.000	16.750	16.277	16.473	7,880	3,086	19,690	5,330	64,480	18,955	1.73
*KC180XP0	18.000	18.750	18.277	18.473	8,840	3,295	22,090	5,760	81,190	22,712	1.94
*KC200XP0	20.000	20.750	20.277	20.473	9,800	3,492	24,500	6,170	99,830	26,695	2.16
*KC250XP0	25.000	25.750	25.277	25.473	12,200	3,941	30,510	7,140	154,800	37,518	2.69
*KC300XP0	30.000	30.750	30.277	30.473	14,610	4,338	36,520	8,050	221,900	49,436	3.21

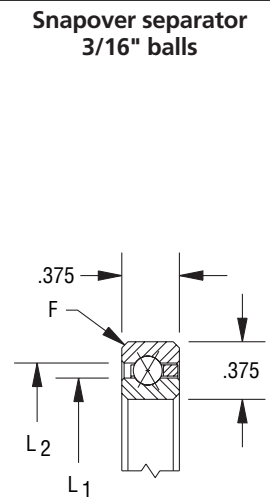

③ F = .040
Bearing corners are normally chamfered

KD SERIES											
KAYDON Bearing Number	Dimensions in Inches				Capacities ^①						Approx. Weight in Pounds
	Bore	Outside Dia.	Land Dia. L ₁	Land Dia. L ₂	Radial (lbs)		Thrust (lbs)		Moment (in-lbs)		
					Static ^②	Dyn.	Static ^②	Dyn.	Static ^②	Dyn.	
KD040XP0	4.000	5.000	4.370	4.630	3,080	2,311	7,700	3,520	6,930	3,901	.78
KD042XP0	4.250	5.250	4.620	4.880	3,190	2,355	7,980	3,600	7,580	4,196	.83
KD045XP0	4.500	5.500	4.870	5.130	3,420	2,454	8,550	3,770	8,550	4,602	.88
KD047XP0	4.750	5.750	5.120	5.380	3,530	2,496	8,840	3,860	9,280	4,916	.94
KD050XP0	5.000	6.000	5.370	5.630	3,760	2,592	9,410	4,020	10,350	5,348	1.00
KD055XP0	5.500	6.500	5.870	6.130	4,100	2,725	10,260	4,260	12,310	6,134	1.06
KD060XP0	6.000	7.000	6.370	6.630	4,450	2,855	11,120	4,490	14,450	6,961	1.16
KD065XP0	6.500	7.500	6.870	7.130	4,790	2,980	11,970	4,720	16,760	7,826	1.22
KD070XP0	7.000	8.000	7.370	7.630	5,130	3,103	12,830	4,940	19,240	8,730	1.31
KD075XP0	7.500	8.500	7.870	8.130	5,470	3,222	13,680	5,160	21,890	9,669	1.41
KD080XP0	8.000	9.000	8.370	8.630	5,810	3,338	14,540	5,370	24,710	10,643	1.53
KD090XP0	9.000	10.000	9.370	9.630	6,500	3,561	16,250	5,790	30,870	12,693	1.72
KD100XP0	10.000	11.000	10.370	10.630	7,180	3,776	17,960	6,190	37,710	14,872	1.88
KD110XP0	11.000	12.000	11.370	11.630	7,870	3,981	19,670	6,570	45,230	17,173	2.06
KD120XP0	12.000	13.000	12.370	12.630	8,550	4,178	21,380	6,950	53,440	19,590	2.25
KD140XP0	14.000	15.000	14.370	14.630	9,920	4,551	24,800	7,670	71,910	24,755	2.73
*KD160XP0	16.000	17.000	16.370	16.630	11,290	4,899	28,220	8,360	93,110	30,325	3.10
KD180XP0	18.000	19.000	18.370	18.630	12,650	5,226	31,640	9,030	117,000	36,268	3.48
KD200XP0	20.000	21.000	20.370	20.630	14,020	5,534	35,060	9,670	143,700	42,561	3.85
*KD210XP0	21.000	22.000	21.370	21.630	14,710	5,682	36,770	9,980	158,100	45,826	4.04
KD250XP0	25.000	26.000	25.370	25.630	17,440	6,235	43,610	11,180	222,400	59,649	4.79
*KD300XP0	30.000	31.000	30.370	30.630	20,860	6,856	52,160	12,600	318,100	78,447	5.73

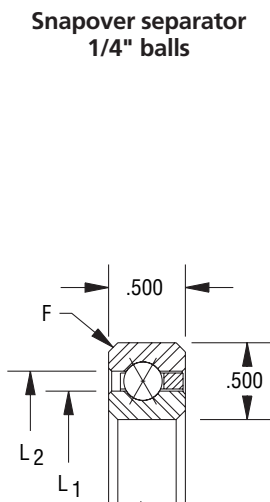

③ F = .060
Bearing corners are normally chamfered

① Capacities listed are not simultaneous. For combined loading see discussion of Bearing Selection and Load Analysis. Dynamic capacities are based upon 1 million revolutions of L10 life. Published capacities do not apply to hybrid series bearings P, X, and Y - contact KAYDON product engineering for values.
 ② Static capacities are non-brinell limits based on rigid support from the shaft and housing.
 ③ "F" is the maximum shaft or housing fillet radius the bearing corners will clear.
 * Contact KAYDON for lead time and minimum purchase requirement.

TYPE X – OPEN REALI-SLIM® BEARINGS, FOUR-POINT CONTACT

Section 2–Selection Tables

KF SERIES												
KAYDON Bearing Number	Dimensions in Inches				Capacities ^①						Approx. Weight in Pounds	
	Bore	Outside Dia.	Land Dia. L ₁	Land Dia. L ₂	Radial (lbs)		Thrust (lbs)		Moment (in-lbs)			
					Static ^②	Dyn.	Static ^②	Dyn.	Static ^②	Dyn.		
KF040XP0	4.000	5.500	4.555	4.945	5,360	4,665	13,400	6,830	12,730	8,312	1.9	
KF042XP0	4.250	5.750	4.805	5.195	5,640	4,795	14,110	7,070	14,110	8,993	2.0	
KF045XP0	4.500	6.000	5.055	5.445	5,930	4,923	14,810	7,300	15,550	9,695	2.1	
KF047XP0	4.750	6.250	5.305	5.695	6,210	5,048	15,520	7,530	17,070	10,416	2.2	
KF050XP0	5.000	6.500	5.555	5.945	6,490	5,172	16,220	7,760	18,660	11,157	2.3	
KF055XP0	5.500	7.000	6.055	6.445	7,050	5,415	17,630	8,200	22,040	12,696	2.5	
KF060XP0	6.000	7.500	6.555	6.945	7,620	5,651	19,050	8,630	25,710	14,311	2.7	
KF065XP0	6.500	8.000	7.055	7.445	8,180	5,880	20,460	9,050	29,660	15,993	2.9	
KF070XP0	7.000	8.500	7.555	7.945	8,750	6,103	21,870	9,460	33,890	17,744	3.2	
KF075XP0	7.500	9.000	8.055	8.445	9,310	6,323	23,280	9,870	38,410	19,568	3.4	
KF080XP0	8.000	9.500	8.555	8.945	9,880	6,535	24,690	10,260	43,200	21,453	3.5	
KF090XP0	9.000	10.500	9.555	9.945	11,000	6,947	27,510	11,030	53,640	25,410	3.9	
KF100XP0	10.000	11.500	10.555	10.945	12,130	7,342	30,330	11,770	65,210	29,608	4.3	
KF110XP0	11.000	12.500	11.555	11.945	13,260	7,721	33,150	12,490	77,910	34,032	4.8	
KF120XP0	12.000	13.500	12.555	12.945	14,390	8,084	35,970	13,190	91,730	38,666	5.2	
KF140XP0	14.000	15.500	14.555	14.945	16,650	8,775	41,620	14,530	122,800	48,556	6.0	
KF160XP0	16.000	17.500	16.555	16.945	18,900	9,421	47,260	15,820	158,300	59,200	7.1	
*KF180XP0	18.000	19.500	18.555	18.945	21,160	10,028	52,900	17,060	198,400	70,537	7.9	
*KF200XP0	20.000	21.500	20.555	20.945	23,420	10,602	58,550	18,250	243,000	82,528	8.9	
*KF250XP0	25.000	26.500	25.555	25.945	29,060	11,909	72,650	21,070	374,200	115,037	10.9	
*KF300XP0	30.000	31.500	30.555	30.945	34,700	13,065	86,760	23,720	533,600	150,708	13.0	
*KF350XP0	35.000	36.500	35.555	35.945	40,350	14,100	100,900	26,220	721,200	189,106	15.1	
*KF400XP0	40.000	41.500	40.555	40.945	45,990	15,034	115,000	28,620	937,100	229,832	17.2	

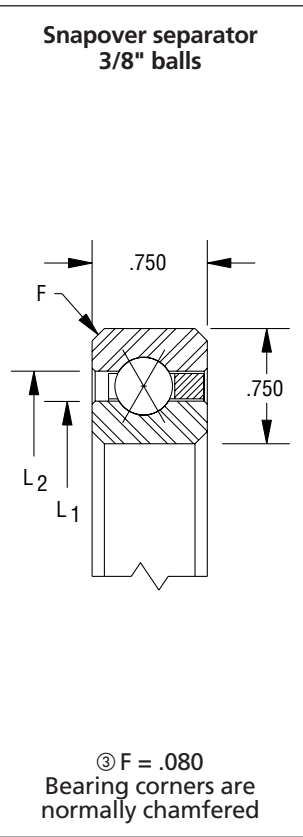

KG SERIES												
KAYDON Bearing Number	Dimensions in Inches				Capacities ^①						Approx. Weight in Pounds	
	Bore	Outside Dia.	Land Dia. L ₁	Land Dia. L ₂	Radial (lbs)		Thrust (lbs)		Moment (in-lbs)			
					Static ^②	Dyn.	Static ^②	Dyn.	Static ^②	Dyn.		
*KG040XP0	4.000	6.000	4.742	5.258	8,210	7,979	20,520	11,260	20,520	14,966	3.6	
*KG042XP0	4.250	6.250	4.992	5.508	8,210	7,917	20,520	11,260	21,550	15,592	3.8	
*KG045XP0	4.500	6.500	5.242	5.758	8,760	8,205	21,890	11,750	24,080	16,930	4.0	
*KG047XP0	4.750	6.750	5.492	6.008	9,300	8,487	23,260	12,230	26,740	18,306	4.1	
KG050XP0	5.000	7.000	5.742	6.258	9,850	8,762	24,620	12,710	29,550	19,721	4.3	
*KG055XP0	5.500	7.500	6.242	6.758	10,400	8,979	25,990	13,180	33,790	21,896	4.7	
KG060XP0	6.000	8.000	6.742	7.258	11,490	9,503	28,730	14,090	40,220	24,956	5.1	
*KG065XP0	6.500	8.500	7.242	7.758	12,040	9,713	30,100	14,530	45,140	27,327	5.4	
KG070XP0	7.000	9.000	7.742	8.258	13,130	10,208	32,830	15,400	52,530	30,636	5.8	
KG075XP0	7.500	9.500	8.242	8.758	13,680	10,410	34,200	15,820	58,140	33,196	6.1	
KG080XP0	8.000	10.000	8.742	9.258	14,770	10,882	36,940	16,650	66,480	36,743	6.5	
KG090XP0	9.000	11.000	9.742	10.258	16,420	11,526	41,040	17,870	82,080	43,240	7.2	
KG100XP0	10.000	12.000	10.742	11.258	18,060	12,147	45,140	19,040	99,320	50,124	7.9	
KG110XP0	11.000	13.000	11.742	12.258	19,700	12,739	49,250	20,180	118,200	57,347	8.6	
KG120XP0	12.000	14.000	12.742	13.258	21,340	13,315	53,350	21,280	138,700	64,935	9.3	
KG140XP0	14.000	16.000	14.742	15.258	24,620	14,404	61,560	23,410	184,700	81,056	10.8	
KG160XP0	16.000	18.000	16.742	17.258	27,910	15,425	69,770	25,450	237,200	98,373	12.3	
KG180XP0	18.000	20.000	18.742	19.258	31,190	16,386	77,980	27,410	296,300	116,793	13.7	
KG200XP0	20.000	22.000	20.742	21.258	34,470	17,293	86,180	29,300	362,000	136,238	15.8	
KG220XP0	22.000	24.000	22.742	23.258	37,760	18,152	94,390	31,130	434,200	156,625	17.3	
KG250XP0	25.000	27.000	25.742	26.258	42,680	19,360	106,700	33,780	554,900	188,838	19.5	
*KG300XP0	30.000	32.000	30.742	31.258	50,890	21,200	127,200	37,980	788,800	246,541	23.3	
KG350XP0	35.000	37.000	35.742	36.258	59,100	22,845	147,700	41,970	1,064,000	308,527	27.1	
KG400XP0	40.000	42.000	40.742	41.258	67,310	24,332	168,300	45,770	1,380,000	374,256	30.8	

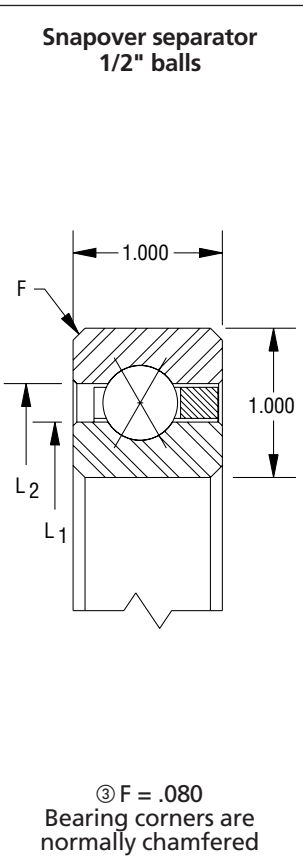

① Capacities listed are not simultaneous. For combined loading see discussion of Bearing Selection and Load Analysis. Dynamic capacities are based upon 1 million revolutions of L10 life. Published capacities do not apply to hybrid series bearings P, X, and Y - contact KAYDON product engineering for values.
 ② Static capacities are non-brinell limits based on rigid support from the shaft and housing.
 ③ "F" is the maximum shaft or housing fillet radius the bearing corners will clear.
 * Contact KAYDON for lead time and minimum purchase requirement.

Sealed REALI-SLIM® Bearing Selections

Seals and Shields Available

To realize the full benefits from anti-friction bearings, it is important to keep them clean and well lubricated. Seals and shields properly designed and mounted help to accomplish this. In this catalog these terms have the following definitions:

Seal—a contacting closure between the stationary and rotating members, for retaining lubricant within and excluding foreign material from the bearing. Seals are retained in the outer race and make positive contact with the inner race.

Shield—a closure for the same purpose as a seal but without positive contact.

A seal is more effective, but requires more turning effort (torque), generates more heat, and as a result, has a lower speed limit than an open or shielded bearing.

The accompanying illustrations are examples by which REALI-SLIM® bearings may be sealed or shielded, either integrally or externally. The lubricant and lubrication systems, torque requirements, speed, and operating environment will influence the choice.

Integral seals and shields offer a very compact overall design with the additional advantage of protecting the bearing before, during and after installation.

Figure 2-1 shows a double-sealed REALI-SLIM® bearing, available from stock in the JU series. In this case, adding shields and seals requires an increase in the width of the bearing (see page 12, Position 2). In the case of JA, JB, and JG double-sealed REALI-SLIM® bearings, the bearing width is the same as that of the open bearing.

Illustrated in Figure 2-2 is a double LAMI-SEAL® bearing. Shown in Figure 2-3 is a double LAMI-SHIELD® bearing for use where a shield will suffice or is required due to torque limitations or speed.

Where weight and space are at a premium, and a seal or shield is required on one side only, single-sealed or single-shielded bearings as shown in Figures 2-4, 2-5 and 2-6 may be supplied.

Note: Sealed REALI-SLIM® bearings are pre-lubricated with a general purpose grease. Operating conditions (i.e. time, temperature, speed, environment) may result in premature lubrication degradation. A variety of lubricants are available as options to meet your specifications.

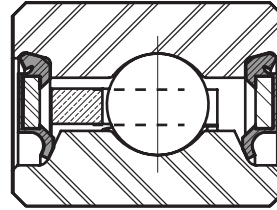

Figure 2-1
Double-Sealed REALI-SLIM® bearing

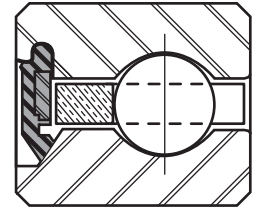

Figure 2-4
Single-Sealed REALI-SLIM® bearing

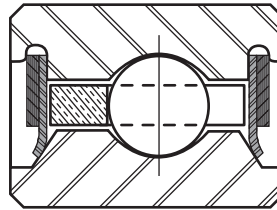

Figure 2-2
Double LAMI-SEAL® bearing

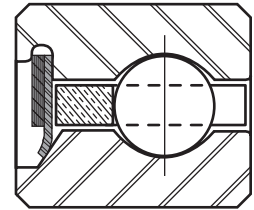

Figure 2-5
Single LAMI-SEAL® bearing

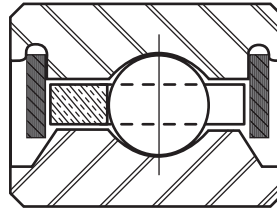

Figure 2-3
Double LAMI-SHIELD® bearing

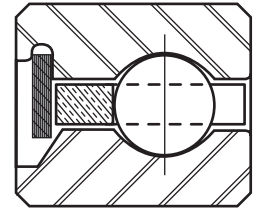

Figure 2-6
Single LAMI-SHIELD® bearing

Note: Pictures are for illustration only and are not intended for design specification.

SEALED REALI-SLIM® BEARINGS, SEALS AND SHIELDS (continued)

Figure 2-7 shows a nitrile lip-type seal ring available in a variety of cross-sections compatible with the REALI-SLIM® bearing series. While this is a very effective seal, torque is substantial and speeds must not exceed 1000 feet per minute if continuous.

If grease lubrication is used and torque is not critical, a very effective shield is that shown in Figure 2-8 where annular grooves are cut in the housing shoulder and clamp plate and filled with grease.

When a separate shield is required, washers made from precision flat stock are ideal, as shown in Figure 2-9. They serve well where weight limitations are strict.

Whether or not integral seals or shields are specified, bearings must be isolated from hostile environments and debris.

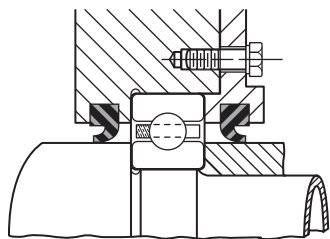

Figure 2-7
Nitrile Lip-Type Seal

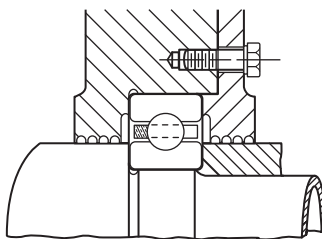

Figure 2-8
Annular Grooves

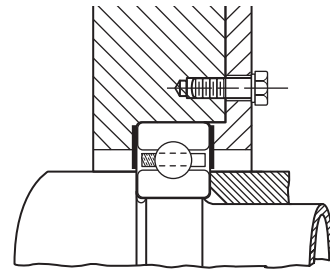

Figure 2-9
Washer Shield From
Precision Flat Stock

Sealed REALI-SLIM® Bearing Selections

Type C

Radial Contact

JHA SERIES (DOUBLE SEALED)									
KAYDON Bearing Number	Dimensions in Inches				Radial Capacity (lbs.) ^①		Limiting Speeds (RPM ^{**})	Torque Max. No Load (in-oz) ^④	Approx. Weight in Pounds
	Bore	Outside Dia.	Land Dia. L ₁	Land Dia. L ₂	Static ^②	Dyn.			
JHA10CL0	1.000	1.375	1.108	1.274	290	188	6110	5	.035
JHA15CL0	1.500	1.875	1.608	1.774	400	225	4300	5	.052
JHA17CL0	1.750	2.125	1.858	2.024	460	242	3750	6	.060

Snapover separator
3/32" balls

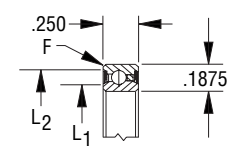

③ F = .015
Bearing corners are normally chamfered

JA SERIES (DOUBLE SEALED)									
KAYDON Bearing Number	Dimensions in Inches				Radial Capacity (lbs.) ^①		Limiting Speeds (RPM ^{**})	Torque Max. No Load (in-oz) ^④	Approx. Weight in Pounds
	Bore	Outside Dia.	Land Dia. L ₁	Land Dia. L ₂	Static ^②	Dyn.			
JA020CP0	2.000	2.500	2.148	2.356	680	393	3,220	6	.10
JA025CP0	2.500	3.000	2.648	2.856	830	442	2,630	8	.12
JA030CP0	3.000	3.500	3.148	3.356	990	487	2,230	12	.14
JA035CP0	3.500	4.000	3.648	3.856	1,140	530	1,930	16	.17
JA040CP0	4.000	4.500	4.148	4.356	1,290	571	1,700	20	.19
JA042CP0	4.250	4.750	4.398	4.606	1,370	591	1,610	24	.20
JA045CP0	4.500	5.000	4.648	4.856	1,440	610	1,520	28	.21
*JA047CP0	4.750	5.250	4.898	5.106	1,520	629	1,450	32	.22
JA050CP0	5.000	5.500	5.148	5.356	1,590	648	1,380	36	.23
*JA055CP0	5.500	6.000	5.648	5.856	1,750	685	1,260	44	.25
*JA060CP0	6.000	6.500	6.148	6.356	1,900	720	1,160	52	.28
*JA065CP0	6.500	7.000	6.648	6.856	2,050	754	1,070	61	.30

Snapover separator
1/8" balls

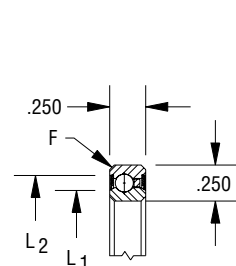

③ F = .025
Bearing corners are normally chamfered

① Capacities listed are not simultaneous. For combined loading see discussion of Bearing Selection and Load Analysis. Dynamic capacities are based upon 1 million revolutions of L10 life. Published capacities do not apply to hybrid series bearings P, X, and Y - contact KAYDON product engineering for values.

② Static capacities are non-brinell limits based on rigid support from the shaft and housing.

③ "F" is the maximum shaft or housing fillet radius the bearing corners will clear.

④ Torque figures shown are for single bearings with standard lubricant at room temperature and under 5 pounds thrust load.

** Values apply to bearings loaded up to 20% of their dynamic capacity.

* Contact KAYDON for lead time and minimum purchase requirement.

TYPE C – SEALED REALI-SLIM® BEARINGS, RADIAL CONTACT

Section 2 – Selection Tables

JB SERIES (DOUBLE SEALED)									
KAYDON Bearing Number	Dimensions in Inches				Radial Capacity (lbs.) ^①		Limiting Speeds (RPM ^{**})	Torque Max. No Load (in-oz) ^④	Approx. Weight in Pounds
	Bore	Outside Dia.	Land Dia. L ₁	Land Dia. L ₂	Static ^②	Dyn.			
JB020CP0	2.000	2.625	2.199	2.425	930	577	3,130	6	.15
JB025CP0	2.500	3.125	2.699	2.925	1,140	644	2,580	8	.19
JB030CP0	3.000	3.625	3.199	3.425	1,340	707	2,190	12	.22
JB035CP0	3.500	4.125	3.699	3.925	1,540	767	1,900	16	.27
JB040CP0	4.000	4.625	4.199	4.425	1,750	825	1,630	20	.30
JB042CP0	4.250	4.875	4.449	4.675	1,830	846	1,600	24	.31
JB045CP0	4.500	5.125	4.699	4.925	1,950	880	1,500	28	.34
*JB047CP0	4.750	5.375	4.949	5.175	2,030	901	1,430	32	.35
*JB050CP0	5.000	5.625	5.199	5.425	2,150	933	1,360	36	.37
*JB055CP0	5.500	6.125	5.699	5.925	2,360	984	1,240	44	.40
*JB060CP0	6.000	6.625	6.199	6.425	2,560	1,034	1,150	52	.44
*JB065CP0	6.500	7.125	6.699	6.925	2,760	1,082	1,060	61	.47

Snapover separator 5/32" balls

③ F = .040
Bearing corners are normally chamfered

JU SERIES (DOUBLE SEALED)									
KAYDON Bearing Number	Dimensions in Inches				Radial Capacity (lbs.) ^①		Limiting Speeds (RPM ^{**})	Torque Max. No Load (in-lb) ^④	Approx. Weight in Pounds
	Bore	Outside Dia.	Land Dia. L ₁	Land Dia. L ₂	Static ^②	Dyn.			
JU040CP0	4.000	4.750	4.150	4.547	2,100	1,073	1,640	2.9	.55
*JU042CP0	4.250	5.000	4.400	4.797	2,220	1,108	1,520	3.2	.58
JU045CP0	4.500	5.250	4.650	5.047	2,340	1,143	1,440	3.5	.61
JU047CP0	4.750	5.500	4.900	5.295	2,460	1,176	1,360	3.9	.65
JU050CP0	5.000	5.750	5.150	5.545	2,590	1,209	1,300	4.3	.68
JU055CP0	5.500	6.250	5.650	6.042	2,830	1,274	1,180	5.1	.74
JU060CP0	6.000	6.750	6.150	6.542	3,070	1,337	1,080	6.1	.81
JU065CP0	6.500	7.250	6.650	7.037	3,315	1,397	1,000	7.0	.87
JU070CP0	7.000	7.750	7.150	7.537	3,550	1,457	920	8.1	.93
JU075CP0	7.500	8.250	7.650	8.037	3,790	1,514	860	9.2	.99
JU080CP0	8.000	8.750	8.150	8.537	4,030	1,570	810	10.4	1.06
JU090CP0	9.000	9.750	9.150	9.535	4,510	1,678	720	13.0	1.18
JU100CP0	10.000	10.750	10.150	10.535	4,990	1,781	650	16.0	1.31
JU110CP0	11.000	11.750	11.150	11.535	5,470	1,879	590	19.2	1.43
*JU120CP0	12.000	12.750	12.150	12.535	5,950	1,974	540	22.8	1.56

Snapover separator 3/16" balls

③ F = .015
Bearing corners are normally chamfered

① Capacities listed are not simultaneous. For combined loading see discussion of Bearing Selection and Load Analysis. Dynamic capacities are based upon 1 million revolutions of L10 life. Published capacities do not apply to hybrid series bearings P, X, and Y - contact KAYDON product engineering for values.

② Static capacities are non-brinell limits based on rigid support from the shaft and housing.

③ "F" is the maximum shaft or housing fillet radius the bearing corners will clear.

④ Torque figures shown are for single bearings with standard lubricant at room temperature and under 5 pounds thrust load.

** Values apply to bearings loaded up to 20% of their dynamic capacity.

* Contact KAYDON for lead time and minimum purchase requirement.

TYPE C – SEALED REALI-SLIM® BEARINGS, RADIAL CONTACT

JG SERIES (DOUBLE SEALED)									
KAYDON Bearing Number	Dimensions in Inches				Radial Capacity (lbs.) ^①		Limiting Speeds (RPM)**	Torque Max. No Load (in-lb) ^④	Approx. Weight in Pounds
	Bore	Outside Dia.	Land Dia. L ₁	Land Dia. L ₂	Static ^②	Dyn.			
*JG070CP0	7.000	9.000	7.554	8.602	13,130	7,764	240	17	5.8
*JG075CP0	7.500	9.500	8.054	9.102	13,680	7,911	225	19	6.1
*JG080CP0	8.000	10.000	8.554	9.602	14,770	8,265	210	21	6.5
*JG090CP0	9.000	11.000	9.554	10.602	16,420	8,743	190	26	7.2
*JG100CP0	10.000	12.000	10.554	11.602	18,060	9,204	175	32	7.9
*JG110CP0	11.000	13.000	11.554	12.602	19,700	9,648	160	38	8.6
*JG120CP0	12.000	14.000	12.554	13.602	21,340	10,074	140	44	9.3
*JG140CP0	14.000	16.000	14.554	15.602	24,620	10,886	125	59	10.8
*JG160CP0	16.000	18.000	16.554	17.602	27,910	11,648	110	76	12.3
*JG180CP0	18.000	20.000	18.554	19.602	31,190	12,367	100	95	13.7
*JG200CP0	20.000	22.000	20.554	21.602	34,470	13,044	90	115	15.8
*JG220CP0	22.000	24.000	22.554	23.602	37,760	13,685	80	139	16.8
*JG250CP0	25.000	27.000	25.554	26.602	42,680	14,591	75	177	19.5
*JG300CP0	30.000	32.000	30.554	31.602	50,890	15,963	60	252	23.3
*JG350CP0	35.000	37.000	35.554	36.602	59,100	17,195	55	339	27.1
*JG400CP0	40.000	42.000	40.554	41.602	67,310	18,307	50	440	30.8

Snapover separator
1/2" balls

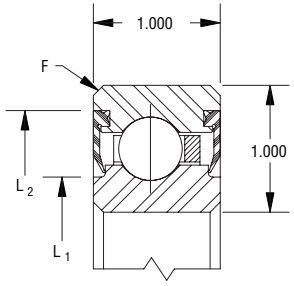

③ F = .080
Bearing corners are normally chamfered

① Capacities listed are not simultaneous. For combined loading see discussion of Bearing Selection and Load Analysis. Dynamic capacities are based upon 1 million revolutions of L₁₀ life. Published capacities do not apply to hybrid series bearings P, X, and Y - contact KAYDON product engineering for values.

② Static capacities are non-brinell limits based on rigid support from the shaft and housing.

③ "F" is the maximum shaft or housing fillet radius the bearing corners will clear.

④ Torque figures shown are for single bearings with standard lubricant at room temperature and under 5 pounds thrust load.

** Values apply to bearings loaded up to 20% of their dynamic capacity.

* Contact KAYDON for lead time and minimum purchase requirement.

CONTACT KAYDON AT—
KAYDON Corporation • Muskegon, Michigan 49443
Telephone: 231/755-3741 • Fax: 231/759-4102

NEED SERVICE FAST?
1-800-514-3066
Website: www.kaydonbearings.com

Sealed REALI-SLIM® Bearing Selections

Type X

Four-Point Contact

JHA SERIES (DOUBLE SEALED)													
KAYDON Bearing Number	Dimensions in Inches				Capacities ^①						Limiting Speeds (RPM ^{**})	Torque Max. No Load (in-oz) ^④	Approx. Weight in Pounds
	Bore	Outside Dia.	Land Dia. L ₁	Land Dia. L ₂	Radial (lbs)		Thrust (lbs)		Moment (in-lbs)				
					Static ^②	Dyn.	Static ^②	Dyn.	Static ^②	Dyn.			
JHA10XL0	1.000	1.375	1.108	1.274	290	247	730	370	170	110	3,000	5	.035
JHA15XL0	1.500	1.875	1.608	1.774	400	296	1,000	460	340	187	2,000	5	.052
JHA17XL0	1.750	2.125	1.858	2.024	460	319	1,140	500	440	232	1,710	6	.060

Snapover separator 3/32" balls

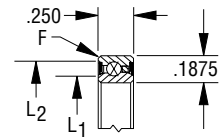

③ F = .015
Bearing corners are normally chamfered

JA SERIES (DOUBLE SEALED)													
KAYDON Bearing Number	Dimensions in Inches				Capacities ^①						Limiting Speeds (RPM ^{**})	Torque Max. No Load (in-oz) ^④	Approx. Weight in Pounds
	Bore	Outside Dia.	Land Dia. L ₁	Land Dia. L ₂	Radial (lbs)		Thrust (lbs)		Moment (in-lbs)				
					Static ^②	Dyn.	Static ^②	Dyn.	Static ^②	Dyn.			
JA020XP0	2.000	2.500	2.148	2.356	680	514	1,710	790	770	434	1,500	6	.10
JA025XP0	2.500	3.000	2.648	2.856	830	583	2,090	910	1,150	601	1,200	8	.12
JA030XP0	3.000	3.500	3.148	3.356	990	643	2,470	1,010	1,600	785	830	12	.14
JA035XP0	3.500	4.000	3.648	3.856	1,140	701	2,850	1,110	2,130	986	710	16	.17
JA040XP0	4.000	4.500	4.148	4.356	1,290	756	3,220	1,210	2,740	1,205	620	20	.19
JA042XP0	4.250	4.750	4.398	4.606	1,370	783	3,410	1,260	3,070	1,321	580	24	.20
JA045XP0	4.500	5.000	4.648	4.856	1,440	809	3,600	1,310	3,420	1,441	550	28	.21
*JA047XP0	4.750	5.250	4.898	5.106	1,520	834	3,790	1,350	3,790	1,565	520	32	.22
JA050XP0	5.000	5.500	5.148	5.356	1,590	859	3,980	1,400	4,180	1,693	500	36	.23
*JA055XP0	5.500	6.000	5.648	5.856	1,750	908	4,360	1,480	5,020	1,959	450	44	.25
JA060XP0	6.000	6.500	6.148	6.356	1,900	955	4,740	1,570	5,930	2,240	330	52	.28
JA065XP0	6.500	7.000	6.648	6.856	2,050	1,001	5,120	1,650	6,910	2,535	300	61	.30

Snapover separator 1/8" balls

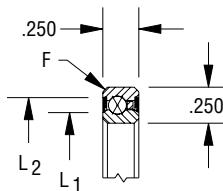

③ F = .025
Bearing corners are normally chamfered

① Capacities listed are not simultaneous. For combined loading see discussion of Bearing Selection and Load Analysis. Dynamic capacities are based upon 1 million revolutions of L10 life. Published capacities do not apply to hybrid series bearings P, X, and Y - contact KAYDON product engineering for values.

② Static capacities are non-brinell limits based on rigid support from the shaft and housing.

③ "F" is the maximum shaft or housing fillet radius the bearing corners will clear.

④ Torque figures shown are for single bearings with standard lubricant at room temperature and under 5 pounds thrust load.

** Values apply to bearings loaded up to 20% of their dynamic capacity.

* Contact KAYDON for lead time and minimum purchase requirement.

TYPE X – SEALED REALI-SLIM® BEARINGS, FOUR-POINT CONTACT

JB SERIES (DOUBLE SEALED)													
KAYDON Bearing Number	Dimensions in Inches				Capacities ^①						Limiting Speeds (RPM ^{**})	Torque Max. No Load (in-oz) ^③	Approx. Weight in Pounds
	Bore	Outside Dia.	Land Dia. L ₁	Land Dia. L ₂	Radial (lbs)		Thrust (lbs)		Moment (in-lbs)				
					Static ^②	Dyn.	Static ^②	Dyn.	Static ^②	Dyn.			
JB020XP0	2.000	2.625	2.199	2.425	930	758	2,340	1,130	1,080	658	1,500	6	.15
JB025XP0	2.500	3.125	2.699	2.925	1,140	848	2,840	1,290	1,600	895	1,200	8	.19
JB030XP0	3.000	3.625	3.199	3.425	1,340	933	3,350	1,440	2,220	1,159	1,000	12	.22
JB035XP0	3.500	4.125	3.699	3.925	1,540	1,014	3,860	1,590	2,940	1,450	710	16	.27
JB040XP0	4.000	4.625	4.199	4.425	1,750	1,091	4,370	1,720	3,770	1,764	620	20	.30
JB042XP0	4.250	4.875	4.449	4.675	1,830	1,120	4,570	1,780	4,170	1,917	590	24	.31
JB045XP0	4.500	5.125	4.699	4.925	1,950	1,165	4,880	1,850	4,690	2,103	550	28	.34
*JB047XP0	4.750	5.375	4.949	5.175	2,030	1,193	5,080	1,900	5,140	2,265	520	32	.35
*JB050XP0	5.000	5.625	5.199	5.425	2,150	1,236	5,380	1,980	5,720	2,463	500	36	.37
*JB055XP0	5.500	6.125	5.699	5.925	2,360	1,304	5,890	2,100	6,850	2,844	450	44	.40
*JB060XP0	6.000	6.625	6.199	6.425	2,560	1,371	6,400	2,220	8,080	3,247	410	52	.44
*JB065XP0	6.500	7.125	6.699	6.925	2,760	1,435	6,910	2,340	9,410	3,668	380	61	.47

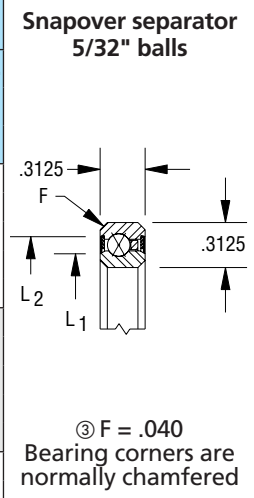

JU SERIES (DOUBLE SEALED)													
KAYDON Bearing Number	Dimensions in Inches				Capacities ^①						Limiting Speeds (RPM ^{**})	Torque Max. No Load (in-lb) ^③	Approx. Weight in Pounds
	Bore	Outside Dia.	Land Dia. L ₁	Land Dia. L ₂	Radial (lbs)		Thrust (lbs)		Moment (in-lbs)				
					Static ^②	Dyn.	Static ^②	Dyn.	Static ^②	Dyn.			
JU040XP0	4.000	4.750	4.150	4.547	2,100	1,417	5,260	2,210	4,600	2,326	620	2.9	.55
JU042XP0	4.250	5.000	4.400	4.797	2,220	1,464	5,560	2,290	5,140	2,541	590	3.2	.58
JU045XP0	4.500	5.250	4.650	5.047	2,340	1,510	5,860	2,380	5,710	2,762	550	3.5	.61
JU047XP0	4.750	5.500	4.900	5.295	2,460	1,556	6,160	2,460	6,320	2,991	520	3.9	.65
JU050XP0	5.000	5.750	5.150	5.545	2,590	1,600	6,460	2,540	6,950	3,226	500	4.3	.68
JU055XP0	5.500	6.250	5.650	6.042	2,830	1,687	7,060	2,690	8,300	3,717	450	5.1	.74
JU060XP0	6.000	6.750	6.150	6.542	3,070	1,770	7,660	2,840	9,770	4,234	410	6.1	.81
JU065XP0	6.500	7.250	6.650	7.037	3,310	1,851	8,270	2,990	11,370	4,775	380	7.0	.87
JU070XP0	7.000	7.750	7.150	7.537	3,550	1,931	8,870	3,130	13,080	5,341	350	8.1	.93
JU075XP0	7.500	8.250	7.650	8.037	3,790	2,007	9,470	3,270	14,910	5,930	330	9.2	.99
JU080XP0	8.000	8.750	8.150	8.537	4,030	2,082	10,070	3,410	16,870	6,542	310	10.4	1.06
JU090XP0	9.000	9.750	9.150	9.535	4,510	2,226	11,270	3,670	21,130	7,830	220	13.0	1.18
JU100XP0	10.000	10.750	10.150	10.535	4,990	2,364	12,470	3,930	25,880	9,201	200	16.0	1.31
JU110XP0	11.000	11.750	11.150	11.535	5,470	2,496	13,680	4,180	31,110	10,651	180	19.2	1.43
*JU120XP0	12.000	12.750	12.150	12.535	5,950	2,622	14,880	4,420	36,830	12,174	160	22.8	1.56

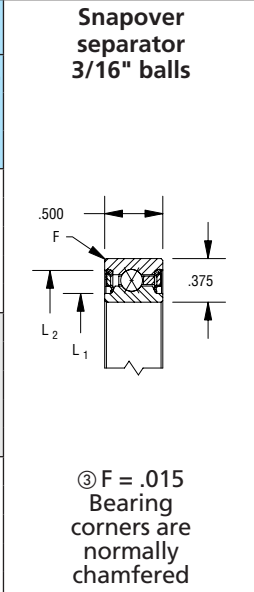

① Capacities listed are not simultaneous. For combined loading see discussion of Bearing Selection and Load Analysis. Dynamic capacities are based upon 1 million revolutions of L10 life. Published capacities do not apply to hybrid series bearings P, X, and Y - contact KAYDON product engineering for values.
 ② Static capacities are non-brinell limits based on rigid support from the shaft and housing.
 ③ "F" is the maximum shaft or housing fillet radius the bearing corners will clear.
 ④ Torque figures shown are single bearings with standard lubricant at room temperature and under 5 pound thrust load.
 ** Values apply to bearings loaded up to 20% of their dynamic capacity.
 * Contact KAYDON for lead time and minimum purchase requirement.

TYPE X – SEALED REALI-SLIM® BEARINGS, FOUR-POINT CONTACT

Section 2 – Selection Tables

JG SERIES													Snapover separator 1/2" balls	
KAYDON Bearing Number	Dimensions in Inches				Capacities ^①						Limiting Speeds (RPM ^{**})	Torque Max. No Load (in-lb) ^④		Approx. Weight in Pounds
	Bore	Outside Dia.	Land Dia. L ₁	Land Dia. L ₂	Radial (lbs)		Thrust (lbs)		Moment (in-lbs)					
					Static ^②	Dyn.	Static ^②	Dyn.	Static ^②	Dyn.				
*JG070XP0	7.000	9.000	7.554	8.602	13,130	10,208	32,830	15,400	52,530	30,636	240	17	5.8	
*JG075XP0	7.500	9.500	8.054	9.102	13,680	10,410	34,200	15,820	58,140	33,196	225	19	6.1	
*JG080XP0	8.000	10.000	8.554	9.602	14,770	10,882	36,940	16,650	66,480	36,743	210	21	6.5	
*JG090XP0	9.000	11.000	9.554	10.602	16,420	11,526	41,040	17,870	82,080	43,240	190	26	7.2	
*JG100XP0	10.000	12.000	10.554	11.602	18,060	12,147	45,140	19,040	99,320	50,124	175	32	7.9	
*JG110XP0	11.000	13.000	11.554	12.602	19,700	12,739	49,250	20,180	118,200	57,347	160	38	8.6	
*JG120XP0	12.000	14.000	12.554	13.602	21,340	13,315	53,350	21,280	138,700	64,935	140	44	9.3	
*JG140XP0	14.000	16.000	14.554	15.602	24,620	14,404	61,560	34,410	184,700	81,056	125	59	10.8	
*JG160XP0	16.000	18.000	16.554	17.602	27,910	15,425	69,770	25,450	237,200	98,373	110	76	12.3	
*JG180XP0	18.000	20.000	18.554	19.602	31,190	16,386	77,980	27,410	296,300	116,793	100	95	13.7	
*JG200XP0	20.000	22.000	20.554	21.602	34,470	17,293	86,180	29,300	362,000	136,238	90	115	15.8	
*JG220XP0	22.000	24.000	22.554	23.602	37,750	18,152	94,390	31,130	434,200	156,625	80	138	16.8	
*JG250XP0	25.000	27.000	25.554	26.602	42,680	19,360	106,700	33,780	554,900	188,838	75	177	19.5	
*JG300XP0	30.000	32.000	30.554	31.602	50,890	21,200	127,200	37,980	788,800	246,541	60	252	23.3	
*JG350XP0	35.000	37.000	35.554	36.602	59,100	22,845	147,700	41,970	1,064,000	308,527	55	339	27.1	
*JG400XP0	40.000	42.000	40.554	41.602	63,310	24,332	168,300	45,770	1,380,000	374,256	50	440	30.8	

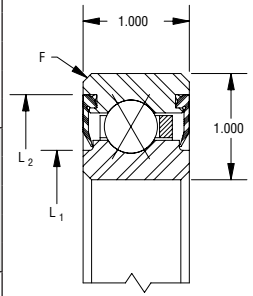

③ F = .080
Bearing corners are normally chamfered

- ① Capacities listed are not simultaneous. For combined loading see discussion of Bearing Selection and Load Analysis. Dynamic capacities are based upon 1 million revolutions of L10 life. Published capacities do not apply to hybrid series bearings P, X, and Y - contact KAYDON product engineering for values.
- ② Static capacities are non-brinell limits based on rigid support from the shaft and housing.
- ③ "F" is the maximum shaft or housing fillet radius the bearing corners will clear.
- ④ Torque figures shown are for single bearings with standard lubricant at room temperature and under 5 pounds thrust load.
- ** Values apply to bearings loaded up to 20% of their dynamic capacity.
- * Contact KAYDON for lead time and minimum purchase requirement.

CONTACT KAYDON AT—
KAYDON Corporation • Muskegon, Michigan 49443
Telephone: 231/755-3741 • Fax: 231/759-4102

NEED SERVICE FAST?
1-800-514-3066
Website: www.kaydonbearings.com

ENDURAKOTE® Plating for Corrosion-Resistant Bearings (Series L, N)

Introduction

ENDURAKOTE® plating protects bearings from corrosion and provides substantial life improvements in hostile environments. ENDURAKOTE® plating is applied over conventional bearing materials such as AISI 52100 steel, and offers the benefit of corrosion resistance normally found only in stainless steel bearings. The coating is applied to each entire bearing race ring, including the paths, thus leaving no area exposed. Other commercial chrome or cadmium coatings normally accepted and used cannot be applied to the path due to the rolling contact stresses. ENDURAKOTE® plating is hard chromium, electrodeposited by a proprietary process which achieves a true molecular bond, and will not flake or peel even under the high contact stresses experienced in the bearing paths.

Laboratory and field testing results have proven the benefits of this process. Severe salt spray testing has shown that bearings with ENDURAKOTE® plating withstand corrosion as well as or better than AISI 440C stainless steel. The hard, dense exterior surface formed by the coating is extremely wear resistant and is excellent in the retention of the lubricant film. Conventional life testing of AISI 52100 steel bearings with ENDURAKOTE® plating has shown that no life de-rating is necessary. In fact, the extremely hard surface of ENDURAKOTE® plating protects the bearing from surface generated damage which can promote premature failure. Since the coating is capable of withstanding extremely high temperatures, the bearings are limited by the bearing materials or lubricant used.

The coating used for ENDURAKOTE® plating can be applied to any type of bearing and to most bearing materials. Its primary advantage is to utilize stock materials such as AISI 52100, etc. with their economies, and convert them to wear and corrosion resistant bearings. This is particularly beneficial for larger diameter bearings or where quick delivery is critical. Thus, cost savings can be achieved over more exotic or specialized materials. Also, stock bearings can have ENDURAKOTE® plating applied for quick delivery.

The net result is that we can offer bearings with the capacity of conventional bearing steels and the corrosion resistance of AISI 440C stainless steel from standard AISI 52100 stock components.

Application

ENDURAKOTE® plating provides corrosion resistance and is effective in increasing wear resistance in sliding surface contacts such as the lands where the cage pilots. The micro-surface composition of ENDURAKOTE® plating aids in lubricant dispersion, enhancing base metals to the degree of reducing or eliminating galling, seizing, and high friction, over a wide range of installations and environments.

Advantages

ENDURAKOTE® plating effects a buildup of less than .0002 under normal circumstances. Thus, it can often be applied to stock bearing components which have been specially selected. ENDURAKOTE® plating is compatible with most ferrous and nonferrous metal, allowing maximum flexibility in selection of base material. ENDURAKOTE® plating is normally a final process, and its quality is constant with any given base metal, insuring design reproducibility.

Properties and Characteristics

A. Hardness

ENDURAKOTE® plating, as deposited, has an equivalent hardness in excess of 70 Rockwell "C." When measured by conventional micro-hardness methods, the host material will modify this measurement to some degree.

B. Coefficient of Friction

(Note: Measurements made at 72°F, using other materials for comparison.)

Material	Against Material	Static	—	Sliding
Steel	Steel	0.30	—	0.20
Steel	Brass, Bronze	0.25	—	0.20
Steel	ENDURAKOTE® plating	0.17	—	0.16
Brass, Bronze	ENDURAKOTE® plating	0.15	—	0.13
ENDURAKOTE® plating	ENDURAKOTE® plating	0.14	—	0.12

ENDURAKOTE® Plating (continued)**C. Adhesion**

ENDURAKOTE® plating will not flake, crack, chip, peel or otherwise separate from the base material under standard bend tests or under conditions where severe heat is induced. The adherence is adequate to withstand the extremely high compressive stresses in the contact areas of ball and roller bearings.

D. Effect On Base

The purity of the chromium surface will not be less than 99% as deposited. A comprehensive testing program at KAYDON established that bearings with ENDURAKOTE® plating exhibited load carrying capacities and life expectancy equal to or better than uncoated AISI 52100 steel bearings.

E. Corrosion Resistance

ENDURAKOTE® plating resists attack by most organic and inorganic compounds with a pH within the range of 4 and 11, except sulfuric and hydrochloric acids. Porosity of the base metal, compound concentration and exposure time to the compound become corrosion factors, but ENDURAKOTE® plating greatly enhances the base material. In severe salt spray tests as well as tap water immersion tests, AISI 52100 steel with ENDURAKOTE® plating proved equal to fully hardened AISI 440C stainless steel in resistance to rusting. In many instances, ENDURAKOTE® plating is better for corrosion protection than cadmium plate, zinc plate, phosphates, chromates, black oxide or normal chrome plate. We invite inquiries about and will be pleased to arrange tests to qualify ENDURAKOTE® plating for specific environments.

F. Heat Resistance

REALI-SLIM® bearings with ENDURAKOTE® plating are designed to maintain their operating characteristics over a temperature range from -65°F to 250°F.

G. Surface Quality

ENDURAKOTE® plating conforms to the texture of the existing surface. Ra finish will be improved slightly down to about 8 Ra; below 4 Ra there is little change. ENDURAKOTE® plating has a matte or micro-orange peel surface with very good lubricant retention qualities.

H. Food Industries

ENDURAKOTE® plating is used on food processing equipment.

I. Load Capacity

ENDURAKOTE® plating does not affect the static or dynamic load capacity of the bearing. These values can be found by looking up the corresponding part number starting with "K" in the standard REALI-SLIM® bearing tables.

Bearing Size Capabilities

ENDURAKOTE® plating can be applied to any REALI-SLIM® bearing.

Restrictions

KAYDON does not recommend the use of ENDURAKOTE® plating in any low torque or torque-sensitive applications.

Open ENDURAKOTE®-PLATED ENDURA-SLIM® Bearing Selections

Type A Angular Contact

A deep groove bearing with reduced shoulder on one side of inner or outer race ball path. Snapover assembly permits use of a one-piece circular pocket separator and greater ball complement. These bearings will accept radial load and single direction thrust load and are normally used in conjunction with another bearing of similar construction. Type A bearings require the

application of thrust to establish contact angle. Stock bearings are individual units and when purchased as such must be adjusted at installation to desired running clearance or preload. Matched sets are available. KAYDON also offers matched spacers for applications requiring extra precision.

NAA SERIES										
KAYDON Bearing Number	Dimensions in Inches					Capacities in Pounds ^①				Approx. Weight in Pounds
	Bore	Outside Dia.	Land Dia. L ₁	Land Dia. L ₂	C'Bore Dia. L ₃	Radial		Thrust		
						Static ^②	Dyn.	Static ^②	Dyn.	
*NAA10AG0	1.0000	1.3752	1.140	1.235	1.274	340	194	970	450	.025
*NAA15AG0	1.5000	1.8752	1.640	1.735	1.774	480	238	1,380	560	.038
*NAA17AG0	1.7500	2.1252	1.890	1.985	2.024	530	251	1,520	600	.045

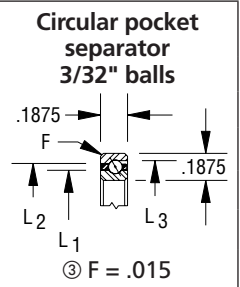

NA SERIES										
KAYDON Bearing Number	Dimensions in Inches					Capacities in Pounds ^①				Approx. Weight in Pounds
	Bore	Outside Dia.	Land Dia. L ₁	Land Dia. L ₂	C'Bore Dia. L ₃	Radial		Thrust		
						Static ^②	Dyn.	Static ^②	Dyn.	
*NA020AR0	2.0000	2.5002	2.186	2.314	2.369	790	405	2,280	960	.10
*NA025AR0	2.5000	3.0002	2.686	2.814	2.869	960	459	2,780	1,100	.12
*NA030AR0	3.0000	3.5002	3.186	3.314	3.367	1,140	507	3,290	1,230	.14
*NA035AR0	3.5000	4.0002	3.686	3.814	3.867	1,310	552	3,790	1,350	.17
*NA040AR0	3.9998	4.5003	4.186	4.314	4.367	1,490	595	4,300	1,470	.19
*NA042AR0	4.2498	4.7503	4.436	4.564	4.615	1,580	616	4,550	1,530	.20
*NA045AR0	4.4998	5.0003	4.686	4.814	4.865	1,660	637	4,810	1,580	.21
*NA047AR0	4.7498	5.2503	4.936	5.064	5.115	1,750	657	5,060	1,640	.22
*NA050AR0	4.9998	5.5003	5.186	5.314	5.365	1,840	676	5,310	1,690	.23
*NA055AR0	5.4998	6.0003	5.686	5.814	5.863	2,020	715	5,820	1,800	.25
*NA060AR0	5.9998	6.5003	6.186	6.314	6.363	2,190	752	6,320	1,900	.28
*NA065AR0	6.4998	7.0003	6.686	6.814	6.861	2,370	788	6,830	2,000	.30
*NA070AR0	6.9998	7.5003	7.186	7.314	7.361	2,540	823	7,340	2,100	.32
*NA075AR0	7.4998	8.0003	7.686	7.814	7.861	2,720	857	7,840	2,190	.34
*NA080AR0	7.9998	8.5003	8.186	8.314	8.359	2,890	890	8,350	2,280	.36
*NA090AR0	8.9998	9.5003	9.186	9.314	9.357	3,240	954	9,360	2,470	.41
*NA100AR0	9.9998	10.5003	10.186	10.314	10.355	3,590	1,014	10,370	2,640	.45
*NA110AR0	10.9998	11.5003	11.186	11.314	11.353	3,940	1,072	11,380	2,810	.50
*NA120AR0	11.9998	12.5003	12.186	12.314	12.349	4,290	1,128	12,390	2,970	.54

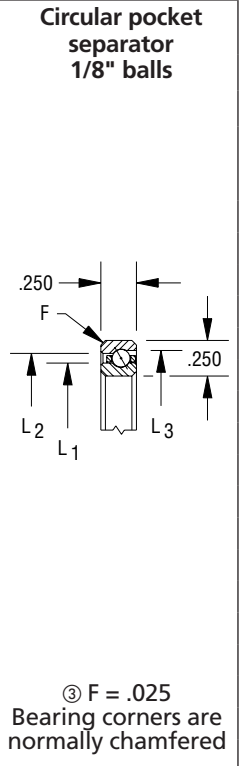

① Capacities listed are not simultaneous. For combined loading see discussion of Bearing Selection and Load Analysis. Dynamic capacities are based upon 1 million revolutions of L10 life. Published capacities do not apply to hybrid series bearings P, X, and Y - contact KAYDON product engineering for values.
 ② Static capacities are non-brinell limits based on rigid support from the shaft and housing.
 ③ "F" is the maximum shaft or housing fillet radius the bearing corners will clear.
 * Contact KAYDON for lead time and minimum purchase requirement.

Open ENDURAKOTE®-PLATED ENDURA-SLIM® Bearings Type A Angular Contact

NB SERIES											Circular pocket separator 5/32" balls
KAYDON Bearing Number	Dimensions in Inches					Capacities in Pounds ^①				Approx. Weight in Pounds	
	Bore	Outside Dia.	Land Dia. L ₁	Land Dia. L ₂	C'Bore Dia. L ₃	Radial		Thrust			
						Static ^②	Dyn.	Static ^②	Dyn.		
*NB020AR0	2.0000	2.6252	2.231	2.393	2.464	1,090	601	3,150	1,380	.15	
*NB025AR0	2.5000	3.1252	2.731	2.893	2.964	1,340	675	3,860	1,590	.19	
*NB030AR0	3.0000	3.6252	3.231	3.393	3.462	1,550	734	4,470	1,750	.22	
*NB035AR0	3.5000	4.1252	3.731	3.893	3.962	1,790	801	5,180	1,930	.27	
*NB040AR0	3.9998	4.6253	4.231	4.393	4.460	2,040	865	5,890	2,100	.30	
*NB042AR0	4.2498	4.8753	4.481	4.643	4.710	2,150	891	6,200	2,170	.31	
*NB045AR0	4.4998	5.1253	4.731	4.893	4.960	2,250	917	6,500	2,240	.34	
*NB047AR0	4.7498	5.3753	4.981	5.143	5.210	2,390	951	6,910	2,340	.35	
*NB050AR0	4.9998	5.6253	5.231	5.393	5.460	2,500	976	7,210	2,410	.37	
*NB055AR0	5.4998	6.1253	5.731	5.893	5.958	2,740	1,033	7,920	2,560	.40	
*NB060AR0	5.9998	6.6253	6.231	6.393	6.458	2,990	1,088	8,630	2,710	.44	
*NB065AR0	6.4998	7.1253	6.731	6.893	6.958	3,200	1,132	9,240	2,840	.47	
*NB070AR0	6.9998	7.6253	7.231	7.393	7.456	3,450	1,184	9,960	2,980	.50	
*NB075AR0	7.4998	8.1253	7.731	7.893	7.955	3,700	1,235	10,670	3,120	.54	
*NB080AR0	7.9998	8.6253	8.231	8.393	8.453	3,940	1,284	11,380	3,260	.57	
*NB090AR0	8.9998	9.6253	9.231	9.393	9.451	4,400	1,370	12,700	3,510	.64	
*NB100AR0	9.9998	10.6253	10.231	10.393	10.449	4,890	1,461	14,120	3,760	.71	
*NB110AR0	10.9998	11.6253	11.231	11.393	11.447	5,350	1,540	15,440	4,000	.78	
*NB120AR0	11.9998	12.6253	12.231	12.393	12.445	5,840	1,623	16,860	4,240	.85	
*NB140AR0	13.9998	14.6253	14.231	14.393	14.439	6,760	1,767	19,500	4,670	.98	
*NB160AR0	15.9998	16.6253	16.231	16.393	16.433	7,710	1,907	22,250	5,100	1.12	
*NB180AR0	17.9998	18.6253	18.231	18.393	18.425	8,660	2,038	24,990	5,510	1.26	
*NB200AR0	19.9998	20.6253	20.231	20.393	20.416	9,610	2,162	27,730	5,900	1.40	

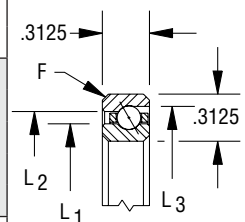

③ F = .040
Bearing corners are normally chamfered

① Capacities listed are not simultaneous. For combined loading see discussion of Bearing Selection and Load Analysis. Dynamic capacities are based upon 1 million revolutions of L10 life. Published capacities do not apply to hybrid series bearings P, X, and Y - contact KAYDON product engineering for values.
 ② Static capacities are non-brinell limits based on rigid support from the shaft and housing.
 ③ "F" is the maximum shaft or housing fillet radius the bearing corners will clear.
 * Contact KAYDON for lead time and minimum purchase requirement.

CONTACT KAYDON AT—
 KAYDON Corporation • Muskegon, Michigan 49443
 Telephone: 231/755-3741 • Fax: 231/759-4102

NEED SERVICE FAST?
1-800-514-3066
 Website: www.kaydonbearings.com

Open ENDURAKOTE®-PLATED ENDURA-SLIM® Bearings Type A Angular Contact

NC SERIES										
KAYDON Bearing Number	Dimensions in Inches					Capacities in Pounds ^①				Approx. Weight in Pounds
	Bore	Outside Dia.	Land Dia. L ₁	Land Dia. L ₂	C'Bore Dia. L ₃	Radial		Thrust		
						Static ^②	Dyn.	Static ^②	Dyn.	
*NC040AR0	3.9998	4.7503	4.277	4.473	4.554	2,550	1,153	7,360	2,770	.44
*NC042AR0	4.2498	5.0003	4.527	4.723	4.804	2,710	1,194	7,820	2,880	.46
*NC045AR0	4.4998	5.2503	4.777	4.973	5.052	2,860	1,234	8,270	2,990	.49
*NC047AR0	4.7498	5.5003	5.027	5.223	5.302	3,020	1,274	8,720	3,100	.51
*NC050AR0	4.9998	5.7503	5.277	5.473	5.552	3,180	1,313	9,170	3,200	.54
*NC055AR0	5.4998	6.2503	5.777	5.973	6.052	3,440	1,374	9,920	3,370	.58
*NC060AR0	5.9998	6.7503	6.277	6.473	6.550	3,750	1,448	10,820	3,580	.64
*NC065AR0	6.4998	7.2503	6.777	6.973	7.050	4,060	1,519	11,720	3,770	.68
*NC070AR0	6.9998	7.7503	7.277	7.473	7.550	4,320	1,575	12,470	3,930	.74
*NC075AR0	7.4998	8.2503	7.777	7.973	8.048	4,630	1,642	13,380	4,120	.78
*NC080AR0	7.9998	8.7503	8.277	8.473	8.548	4,950	1,708	14,280	4,300	.84
*NC090AR0	8.9998	9.7503	9.277	9.473	9.546	5,520	1,822	15,930	4,630	.98
*NC100AR0	9.9998	10.7503	10.277	10.473	10.544	6,140	1,942	17,730	4,970	1.04
*NC110AR0	10.9998	11.7503	11.277	11.473	11.542	6,720	2,047	19,390	5,280	1.14
*NC120AR0	11.9998	12.7503	12.277	12.473	12.540	7,290	2,147	21,040	5,570	1.23
*NC140AR0	13.9998	14.7503	14.277	14.473	14.535	8,490	2,347	24,500	6,170	1.43
*NC160AR0	15.9998	16.7503	16.277	16.473	16.529	9,680	2,533	27,950	6,730	1.63
*NC180AR0	17.9998	18.7503	18.277	18.473	18.523	10,880	2,707	31,410	7,280	1.83
*NC200AR0	19.9998	20.7503	20.277	20.473	20.517	12,030	2,863	34,720	7,780	2.03
*NC250AR0	24.9998	25.7503	25.277	25.473	25.500	14,900	3,233	43,280	9,010	2.52
*NC300AR0	29.9998	30.7503	30.277	30.473	30.484	17,960	3,561	51,850	10,160	3.02

Circular pocket separator
3/16" balls

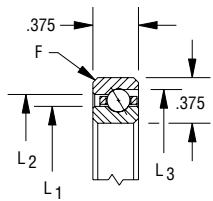

③ F = .040
Bearing corners are normally chamfered

ND SERIES										
KAYDON Bearing Number	Dimensions in Inches					Capacities in Pounds ^①				Approx. Weight in Pounds
	Bore	Outside Dia.	Land Dia. L ₁	Land Dia. L ₂	C'Bore Dia. L ₃	Radial		Thrust		
						Static ^②	Dyn.	Static ^②	Dyn.	
*ND040AR0	3.9998	5.0003	4.370	4.630	4.741	3,550	1,819	10,260	4,260	.80
*ND042AR0	4.2498	5.2503	4.620	4.880	4.991	3,750	1,876	10,830	4,420	.84
*ND045AR0	4.4998	5.5003	4.870	5.130	5.241	3,950	1,931	11,400	4,570	.88
*ND047AR0	4.7498	5.7503	5.120	5.380	5.490	4,150	1,986	11,970	4,720	.93
*ND050AR0	4.9998	6.0003	5.370	5.630	5.740	4,340	2,040	12,540	4,870	.98
*ND055AR0	5.4998	6.5003	5.870	6.130	6.238	4,740	2,145	13,680	5,160	1.06
*ND060AR0	5.9998	7.0003	6.370	6.630	6.738	5,130	2,247	14,820	5,440	1.15
*ND065AR0	6.4998	7.5003	6.870	7.130	7.236	5,530	2,346	15,960	5,720	1.24
*ND070AR0	6.9998	8.0003	7.370	7.630	7.736	5,920	2,442	17,100	5,990	1.33
*ND075AR0	7.4998	8.5003	7.870	8.130	8.236	6,320	2,536	18,240	6,250	1.42
*ND080AR0	7.9998	9.0003	8.370	8.630	8.734	6,710	2,627	19,380	6,510	1.52
*ND090AR0	8.9998	10.0003	9.370	9.630	9.732	7,500	2,803	21,660	7,010	1.69
*ND100AR0	9.9998	11.0003	10.370	10.630	10.732	8,290	2,972	23,940	7,500	1.87
*ND110AR0	10.9998	12.0003	11.370	11.630	11.730	9,080	3,133	26,220	7,960	2.05
*ND120AR0	11.9998	13.0003	12.370	12.630	12.728	9,870	3,288	28,500	8,420	2.23
*ND140AR0	13.9998	15.0003	14.370	14.630	14.724	11,450	3,582	33,060	9,290	2.57
*ND160AR0	15.9998	17.0003	16.370	16.630	16.718	13,030	3,856	37,620	10,130	2.93
*ND180AR0	17.9998	19.0003	18.370	18.630	18.712	14,610	4,113	42,180	10,930	3.29
*ND200AR0	19.9998	21.0003	20.370	20.630	20.705	16,190	4,356	46,740	11,710	3.65
*ND210AR0	20.9998	22.0003	21.370	21.630	21.700	16,981	4,472	49,020	12,086	3.83
*ND250AR0	24.9998	26.0003	25.370	25.630	25.688	20,140	4,908	58,140	13,540	4.54
*ND300AR0	29.9998	31.0003	30.370	30.630	30.672	24,090	5,397	69,540	15,260	5.44

Circular pocket separator
1/4" balls

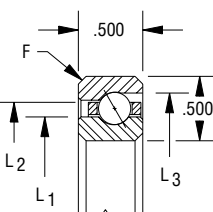

③ F = .060
Bearing corners are normally chamfered

① Capacities listed are not simultaneous. For combined loading see discussion of Bearing Selection and Load Analysis. Dynamic capacities are based upon 1 million revolutions of L10 life. Published capacities do not apply to hybrid series bearings P, X, and Y - contact KAYDON product engineering for values.
 ② Static capacities are non-brinell limits based on rigid support from the shaft and housing.
 ③ "F" is the maximum shaft or housing fillet radius the bearing corners will clear.
 * Contact KAYDON for lead time and minimum purchase requirement.

Open ENDURAKOTE®-PLATED ENDURA-SLIM® Bearings Type A Angular Contact

Section 2-Selection Tables

NF SERIES										
KAYDON Bearing Number	Dimensions in Inches					Capacities in Pounds ^①				Approx. Weight in Pounds
	Bore	Outside Dia.	Land Dia. L ₁	Land Dia. L ₂	C'Bore Dia. L ₃	Radial		Thrust		
						Static ^②	Dyn.	Static ^②	Dyn.	
*NF040AR0	3.9998	5.5003	4.555	4.945	5.115	6,350	3,736	18,340	8,420	1.92
*NF042AR0	4.2498	5.7503	4.805	5.195	5.365	6,600	3,805	19,050	8,630	2.04
*NF045AR0	4.4998	6.0003	5.060	5.445	5.615	7,090	3,966	20,460	9,050	2.14
*NF047AR0	4.7498	6.2503	5.305	5.695	5.865	7,330	4,034	21,160	9,260	2.26
*NF050AR0	4.9998	6.5003	5.555	5.945	6.115	7,570	4,101	21,870	9,460	2.37
*NF055AR0	5.4998	7.0003	6.055	6.445	6.613	8,310	4,319	23,980	10,060	2.59
*NF060AR0	5.9998	7.5003	6.555	6.945	7.113	9,040	4,530	26,100	10,650	2.72
*NF065AR0	6.4998	8.0003	7.055	7.445	7.613	9,770	4,734	28,220	11,220	2.94
*NF070AR0	6.9998	8.5003	7.555	7.945	8.113	10,510	4,932	30,330	11,770	3.16
*NF075AR0	7.4998	9.0003	8.055	8.445	8.610	11,000	5,052	31,740	12,130	3.39
*NF080AR0	7.9998	9.5003	8.555	8.945	9.110	11,730	5,242	33,860	12,670	3.61
*NF090AR0	8.9998	10.5003	9.555	9.945	10.108	13,190	5,608	38,090	13,700	3.95
*NF100AR0	9.9998	11.5003	10.555	10.945	11.106	14,420	5,890	41,620	14,530	4.40
*NF110AR0	10.9998	12.5003	11.555	11.945	12.106	15,880	6,227	45,850	15,500	4.75
*NF120AR0	11.9998	13.5003	12.555	12.945	13.104	17,100	6,487	49,380	16,290	5.20
*NF140AR0	13.9998	15.5003	14.555	14.945	15.102	19,790	7,043	57,140	17,950	5.76
*NF160AR0	15.9998	17.5003	16.555	16.945	17.098	22,480	7,563	64,890	19,540	6.78
*NF180AR0	17.9998	19.5003	18.555	18.945	19.096	25,410	8,103	73,360	21,210	7.67
*NF200AR0	19.9998	21.5003	20.555	20.945	21.092	28,100	8,562	81,120	22,680	8.47
*NF250AR0	24.9998	26.5003	25.555	25.945	26.085	34,700	9,585	100,200	26,100	10.50
*NF300AR0	29.9998	31.5003	30.555	30.945	31.075	41,540	10,533	119,900	29,430	12.50
*NF350AR0	34.9998	36.5003	35.555	35.945	36.064	48,380	11,382	139,700	32,580	14.60
*NF400AR0	39.9998	41.5003	40.555	40.945	41.054	55,220	12,147	159,400	35,580	16.60

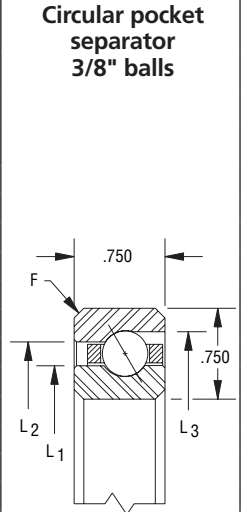

③ F = .080
Bearing corners are normally chamfered

NG SERIES										
KAYDON Bearing Number	Dimensions in Inches					Capacities in Pounds ^①				Approx. Weight in Pounds
	Bore	Outside Dia.	Land Dia. L ₁	Land Dia. L ₂	C'Bore Dia. L ₃	Radial		Thrust		
						Static ^②	Dyn.	Static ^②	Dyn.	
*NG040AR0	3.9998	6.0003	4.742	5.258	5.491	9,480	6,281	27,360	13,630	3.61
*NG042AR0	4.2498	6.2503	4.992	5.508	5.741	9,950	6,438	28,730	14,090	3.83
*NG045AR0	4.4998	6.5003	5.242	5.758	5.989	10,430	6,562	30,100	14,530	3.95
*NG047AR0	4.7498	6.7503	5.492	6.008	6.239	10,900	6,745	31,460	14,970	4.17
*NG050AR0	4.9998	7.0003	5.742	6.258	6.489	11,370	6,897	32,830	15,400	4.42
*NG055AR0	5.4998	7.5003	6.242	6.758	6.989	12,320	7,192	35,570	16,240	4.73
*NG060AR0	5.9998	8.0003	6.742	7.258	7.489	13,270	7,480	38,300	17,060	5.07
*NG065AR0	6.4998	8.5003	7.242	7.758	7.987	14,220	7,761	41,040	17,870	5.41
*NG070AR0	6.9998	9.0003	7.742	8.258	8.487	15,160	8,035	43,780	18,650	5.87
*NG075AR0	7.4998	9.5003	8.242	8.758	8.987	16,110	8,303	46,510	19,420	6.20
*NG080AR0	7.9998	10.0003	8.742	9.258	9.485	17,060	8,566	49,250	20,180	6.54
*NG090AR0	8.9998	11.0003	9.742	10.258	10.485	18,960	9,073	54,720	21,640	7.22
*NG100AR0	9.9998	12.0003	10.742	11.258	11.483	20,850	9,561	60,190	23,060	8.00
*NG110AR0	10.9998	13.0003	11.742	12.258	12.481	22,750	10,027	65,660	24,440	8.68
*NG120AR0	11.9998	14.0003	12.742	13.258	13.481	24,640	10,481	71,140	25,780	9.47
*NG140AR0	13.9998	16.0003	14.742	15.258	15.478	28,430	11,338	82,080	28,360	10.90
*NG160AR0	15.9998	18.0003	16.742	17.258	17.474	32,220	12,142	93,020	30,830	12.40
*NG180AR0	17.9998	20.0003	18.742	19.258	19.472	36,020	12,898	104,000	33,200	13.80
*NG200AR0	19.9998	22.0003	20.742	21.258	21.468	39,810	13,612	114,900	35,490	15.20
*NG220AR0	21.9998	24.0003	22.742	23.258	23.468	43,598	14,290	125,856	37,712	16.63
*NG250AR0	24.9998	27.0003	25.742	26.258	26.461	49,280	15,239	142,300	40,920	18.80
*NG300AR0	29.9998	32.0003	30.742	31.258	31.451	58,760	16,687	169,600	46,020	22.50
*NG350AR0	34.9998	37.0003	35.742	36.258	36.440	68,240	17,982	197,000	50,840	26.20
*NG400AR0	39.9998	42.0003	40.742	41.258	41.430	77,720	19,153	224,400	55,440	29.80

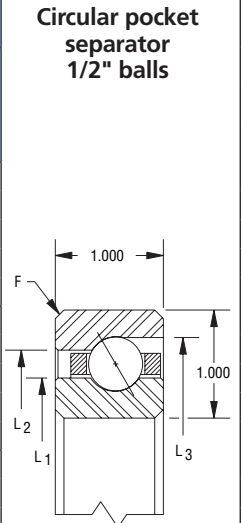

③ F = .080
Bearing corners are normally chamfered

① Capacities listed are not simultaneous. For combined loading see discussion of Bearing Selection and Load Analysis. Dynamic capacities are based upon 1 million revolutions of L10 life. Published capacities do not apply to hybrid series bearings P, X, and Y - contact KAYDON product engineering for values.
 ② Static capacities are non-brinell limits based on rigid support from the shaft and housing.
 ③ "F" is the maximum shaft or housing fillet radius the bearing corners will clear.
 * Contact KAYDON for lead time and minimum purchase requirement.

Open ENDURAKOTE®-PLATED ENDURA-SLIM® Bearing Selections

Type C Radial Contact

A Conrad assembled bearing designed primarily for application of radial load—deep ball grooves also permit application of thrust load in either direction – often used in conjunction with another bearing.

NAA SERIES							
KAYDON Bearing Number	Dimensions in Inches				Radial Capacities in Pounds ^①		Approx. Weight in Pounds
	Bore	Outside Dia.	Land Dia. L ₁	Land Dia. L ₂	Static ^②	Dyn.	
*NAA10CLO	1.0000	1.3752	1.140	1.235	290	188	.026
*NAA15CLO	1.5000	1.8752	1.640	1.735	400	225	.039
*NAA17CLO	1.7500	2.1252	1.890	1.985	460	242	.045

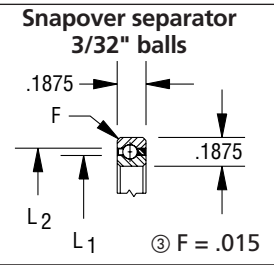

NA SERIES							
KAYDON Bearing Number	Dimensions in Inches				Radial Capacities in Pounds ^①		Approx. Weight in Pounds
	Bore	Outside Dia.	Land Dia. L ₁	Land Dia. L ₂	Static ^②	Dyn.	
*NA020CP0	2.0000	2.5002	2.186	2.314	680	393	.10
*NA025CP0	2.5000	3.0002	2.686	2.814	830	442	.13
*NA030CP0	3.0000	3.5002	3.186	3.314	990	487	.15
*NA035CP0	3.5000	4.0002	3.686	3.814	1,140	530	.18
*NA040CP0	3.9998	4.5003	4.186	4.314	1,290	571	.19
*NA042CP0	4.2498	4.7503	4.436	4.564	1,370	591	.20
*NA045CP0	4.4998	5.0003	4.686	4.814	1,440	610	.22
*NA047CP0	4.7498	5.2503	4.936	5.064	1,520	629	.23
*NA050CP0	4.9998	5.5003	5.186	5.314	1,590	648	.24
*NA055CP0	5.4998	6.0003	5.686	5.814	1,750	685	.25
*NA060CP0	5.9998	6.5003	6.186	6.314	1,900	720	.28
*NA065CP0	6.4998	7.0003	6.686	6.814	2,050	754	.30
*NA070CP0	6.9998	7.5003	7.186	7.314	2,200	787	.31
*NA075CP0	7.4998	8.0003	7.686	7.814	2,350	820	.34
*NA080CP0	7.9998	8.5003	8.186	8.314	2,500	851	.38
*NA090CP0	8.9998	9.5003	9.186	9.314	2,810	912	.44
*NA100CP0	9.9998	10.5003	10.186	10.314	3,110	969	.50
*NA110CP0	10.9998	11.5003	11.186	11.314	3,410	1,025	.52
*NA120CP0	11.9998	12.5003	12.186	12.314	3,720	1,078	.56

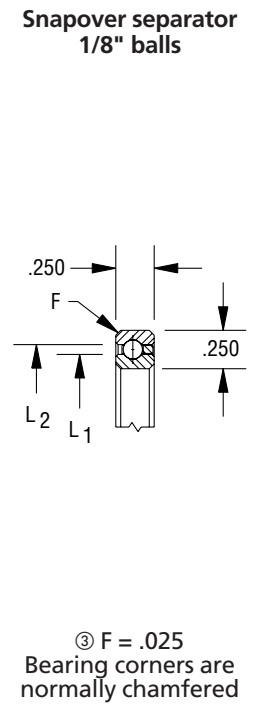

① Capacities listed are not simultaneous. For combined loading see discussion of Bearing Selection and Load Analysis. Dynamic capacities are based upon 1 million revolutions of L10 life. Published capacities do not apply to hybrid series bearings P, X, and Y - contact KAYDON product engineering for values.

② Static capacities are non-brinell limits based on rigid support from the shaft and housing.

③ "F" is the maximum shaft or housing fillet radius the bearing corners will clear.

* Contact KAYDON for lead time and minimum purchase requirement.

Open ENDURAKOTE®-PLATED ENDURA-SLIM® Bearings Type C Radial Contact

NB SERIES							
KAYDON Bearing Number	Dimensions in Inches				Radial Capacities in Pounds ^①		Approx. Weight in Pounds
	Bore	Outside Dia.	Land Dia. L ₁	Land Dia. L ₂	Static ^②	Dyn.	
*NB020CP0	2.0000	2.6252	2.231	2.393	930	577	.16
*NB025CP0	2.5000	3.1252	2.731	2.893	1,140	644	.20
*NB030CP0	3.0000	3.6252	3.231	3.393	1,340	707	.24
*NB035CP0	3.5000	4.1252	3.731	3.893	1,540	767	.27
*NB040CP0	3.9998	4.6253	4.231	4.393	1,750	825	.30
*NB042CP0	4.2498	4.8753	4.481	4.643	1,830	846	.31
*NB045CP0	4.4998	5.1253	4.731	4.893	1,950	880	.33
*NB047CP0	4.7498	5.3753	4.981	5.143	2,030	901	.34
*NB050CP0	4.9998	5.6253	5.231	5.393	2,150	933	.38
*NB055CP0	5.4998	6.1253	5.731	5.893	2,360	984	.41
*NB060CP0	5.9998	6.6253	6.231	6.393	2,560	1,034	.44
*NB065CP0	6.4998	7.1253	6.731	6.893	2,760	1,082	.47
*NB070CP0	6.9998	7.6253	7.231	7.393	2,970	1,129	.50
*NB075CP0	7.4998	8.1253	7.731	7.893	3,170	1,175	.53
*NB080CP0	7.9998	8.6253	8.231	8.393	3,370	1,219	.57
*NB090CP0	8.9998	9.6253	9.231	9.393	3,780	1,304	.66
*NB100CP0	9.9998	10.6253	10.231	10.393	4,190	1,386	.73
*NB110CP0	10.9998	11.6253	11.231	11.393	4,590	1,464	.75
*NB120CP0	11.9998	12.6253	12.231	12.393	5,000	1,539	.83
*NB140CP0	13.9998	14.6253	14.231	14.393	5,810	1,680	1.05
*NB160CP0	15.9998	16.6253	16.231	16.393	6,620	1,812	1.20
*NB180CP0	17.9998	18.6253	18.231	18.393	7,440	1,936	1.35
*NB200CP0	19.9998	20.6253	20.231	20.393	8,250	2,053	1.50

Snapover separator
5/32" balls

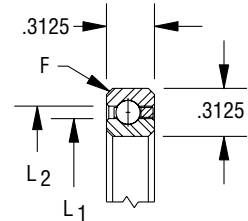

③ F = .040
Bearing corners are normally chamfered

- ① Capacities listed are not simultaneous. For combined loading see discussion of Bearing Selection and Load Analysis. Dynamic capacities are based upon 1 million revolutions of L10 life. Published capacities do not apply to hybrid series bearings P, X, and Y - contact KAYDON product engineering for values.
- ② Static capacities are non-brinell limits based on rigid support from the shaft and housing.
- ③ "F" is the maximum shaft or housing fillet radius the bearing corners will clear.
- * Contact KAYDON for lead time and minimum purchase requirement.

CONTACT KAYDON AT—
 KAYDON Corporation • Muskegon, Michigan 49443
 Telephone: 231/755-3741 • Fax: 231/759-4102

NEED SERVICE FAST?
1-800-514-3066
 Website: www.kaydonbearings.com

Open ENDURAKOTE®-PLATED ENDURA-SLIM® Bearings Type C Radial Contact

NC SERIES							
KAYDON Bearing Number	Dimensions in Inches				Radial Capacities in Pounds ^①		Approx. Weight in Pounds
	Bore	Outside Dia.	Land Dia. L ₁	Land Dia. L ₂	Static ^②	Dyn.	
*NC040CP0	3.9998	4.7503	4.277	4.473	2,100	1,073	.45
*NC042CP0	4.2498	5.0003	4.527	4.723	2,220	1,108	.47
*NC045CP0	4.4998	5.2503	4.777	4.973	2,340	1,143	.48
*NC047CP0	4.7498	5.5003	5.027	5.223	2,460	1,176	.50
*NC050CP0	4.9998	5.7503	5.277	5.473	2,590	1,209	.58
*NC055CP0	5.4998	6.2503	5.777	5.973	2,830	1,274	.59
*NC060CP0	5.9998	6.7503	6.277	6.473	3,070	1,337	.63
*NC065CP0	6.4998	7.2503	6.777	6.973	3,310	1,397	.68
*NC070CP0	6.9998	7.7503	7.277	7.473	3,550	1,457	.73
*NC075CP0	7.4998	8.2503	7.777	7.973	3,790	1,514	.78
*NC080CP0	7.9998	8.7503	8.277	8.473	4,030	1,570	.84
*NC090CP0	8.9998	9.7503	9.277	9.473	4,510	1,678	.94
*NC100CP0	9.9998	10.7503	10.277	10.473	4,990	1,781	1.06
*NC110CP0	10.9998	11.7503	11.277	11.473	5,470	1,879	1.16
*NC120CP0	11.9998	12.7503	12.277	12.473	5,950	1,974	1.25
*NC140CP0	13.9998	14.7503	14.277	14.473	6,910	2,154	1.52
*NC160CP0	15.9998	16.7503	16.277	16.473	7,880	2,321	1.73
*NC180CP0	17.9998	18.7503	18.277	18.473	8,840	2,478	1.94
*NC200CP0	19.9998	20.7503	20.277	20.473	9,800	2,626	2.16
*NC250CP0	24.9998	25.7503	25.277	25.473	12,200	2,962	2.69
*NC300CP0	29.9998	30.7503	30.277	30.473	14,610	3,260	3.21

③ F = .040
Bearing corners are normally chamfered

ND SERIES							
KAYDON Bearing Number	Dimensions in Inches				Radial Capacities in Pounds ^①		Approx. Weight in Pounds
	Bore	Outside Dia.	Land Dia. L ₁	Land Dia. L ₂	Static ^②	Dyn.	
*ND040CP0	3.9998	5.0003	4.370	4.630	3,080	1,755	.78
*ND042CP0	4.2498	5.2503	4.620	4.880	3,190	1,787	.83
*ND045CP0	4.4998	5.5003	4.870	5.130	3,420	1,861	.88
*ND047CP0	4.7498	5.7503	5.120	5.380	3,530	1,892	.94
*ND050CP0	4.9998	6.0003	5.370	5.630	3,760	1,964	1.00
*ND055CP0	5.4998	6.5003	5.870	6.130	4,100	2,063	1.06
*ND060CP0	5.9998	7.0003	6.370	6.630	4,450	2,160	1.16
*ND065CP0	6.4998	7.5003	6.870	7.130	4,790	2,254	1.22
*ND070CP0	6.9998	8.0003	7.370	7.630	5,130	2,345	1.31
*ND075CP0	7.4998	8.5003	7.870	8.130	5,470	2,434	1.41
*ND080CP0	7.9998	9.0003	8.370	8.630	5,810	2,520	1.53
*ND090CP0	8.9998	10.0003	9.370	9.630	6,500	2,688	1.72
*ND100CP0	9.9998	11.0003	10.370	10.630	7,180	2,847	1.88
*ND110CP0	10.9998	12.0003	11.370	11.630	7,870	3,000	2.06
*ND120CP0	11.9998	13.0003	12.370	12.630	8,550	3,148	2.25
*ND140CP0	13.9998	15.0003	14.370	14.630	9,920	3,427	2.73
*ND160CP0	15.9998	17.0003	16.370	16.630	11,290	3,688	3.10
*ND180CP0	17.9998	19.0003	18.370	18.630	12,650	3,933	3.48
*ND200CP0	19.9998	21.0003	20.370	20.630	14,020	4,164	3.85
*ND210CP0	20.9998	22.0003	21.370	21.630	14,706	4,274	4.04
*ND250CP0	24.9998	26.0003	25.370	25.630	17,440	4,689	4.79
*ND300CP0	29.9998	31.0003	30.370	30.360	20,860	5,153	5.73

③ F = .060
Bearing corners are normally chamfered

① Capacities listed are not simultaneous. For combined loading see discussion of Bearing Selection and Load Analysis. Dynamic capacities are based upon 1 million revolutions of L10 life. Published capacities do not apply to hybrid series bearings P, X, and Y - contact KAYDON product engineering for values.
 ② Static capacities are non-brinell limits based on rigid support from the shaft and housing.
 ③ "F" is the maximum shaft or housing fillet radius the bearing corners will clear.
 * Contact KAYDON for lead time and minimum purchase requirement.

Open ENDURAKOTE®-PLATED ENDURA-SLIM® Bearings Type C Radial Contact

Section 2 - Selection Tables

NF SERIES							
KAYDON Bearing Number	Dimensions in Inches				Radial Capacities in Pounds ^①		Approx. Weight in Pounds
	Bore	Outside Dia.	Land Dia. L ₁	Land Dia. L ₂	Static ^②	Dyn.	
*NF040CP0	3.9998	5.5003	4.555	4.945	5,360	3,559	1.9
*NF042CP0	4.2498	5.7503	4.805	5.195	5,640	3,655	2.0
*NF045CP0	4.4998	6.0003	5.055	5.445	5,930	3,750	2.1
*NF047CP0	4.7498	6.2503	5.305	5.695	6,210	3,843	2.2
*NF050CP0	4.9998	6.5003	5.555	5.945	6,490	3,936	2.3
*NF055CP0	5.4998	7.0003	6.055	6.445	7,050	4,116	2.5
*NF060CP0	5.9998	7.5003	6.555	6.945	7,620	4,291	2.7
*NF065CP0	6.4998	8.0003	7.055	7.445	8,180	4,461	2.9
*NF070CP0	6.9998	8.5003	7.555	7.945	8,750	4,628	3.2
*NF075CP0	7.4998	9.0003	8.055	8.445	9,310	4,791	3.4
*NF080CP0	7.9998	9.5003	8.555	8.945	9,880	4,949	3.5
*NF090CP0	8.9998	10.5003	9.555	9.945	11,000	5,256	3.9
*NF100CP0	9.9998	11.5003	10.555	10.945	12,130	5,550	4.3
*NF110CP0	10.9998	12.5003	11.555	11.945	13,260	5,833	4.8
*NF120CP0	11.9998	13.5003	12.555	12.945	14,390	6,105	5.2
*NF140CP0	13.9998	15.5003	14.555	14.945	16,650	6,620	6.0
*NF160CP0	15.9998	17.5003	16.555	16.945	18,900	7,104	7.1
*NF180CP0	17.9998	19.5003	18.555	18.945	21,160	7,557	7.9
*NF200CP0	19.9998	21.5003	20.555	20.945	23,420	7,986	8.9
*NF250CP0	24.9998	26.5003	25.555	25.945	29,060	8,963	10.9
*NF300CP0	29.9998	31.5003	30.555	30.945	34,700	9,828	13.0
*NF350CP0	34.9998	36.5003	35.555	35.945	40,350	10,603	15.1
*NF400CP0	39.9998	41.5003	40.555	40.945	45,990	11,302	17.2

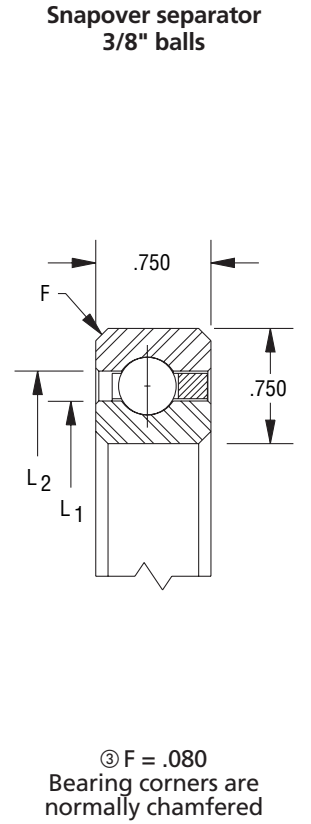

NG SERIES							
KAYDON Bearing Number	Dimensions in Inches				Radial Capacities in Pounds ^①		Approx. Weight in Pounds
	Bore	Outside Dia.	Land Dia. L ₁	Land Dia. L ₂	Static ^②	Dyn.	
*NG040CP0	3.9998	6.0003	4.742	5.258	8,210	6,115	3.6
*NG042CP0	4.2498	6.2503	4.992	5.508	8,210	6,061	3.8
*NG045CP0	4.4998	6.5003	5.242	5.758	8,760	6,277	4.0
*NG047CP0	4.7498	6.7503	5.492	6.008	9,300	6,487	4.1
*NG050CP0	4.9998	7.0003	5.742	6.258	9,850	6,691	4.3
*NG055CP0	5.4998	7.5003	6.242	6.758	10,400	6,850	4.7
*NG060CP0	5.9998	8.0003	6.742	7.258	11,490	7,241	5.1
*NG065CP0	6.4998	8.5003	7.242	7.758	12,040	7,393	5.4
*NG070CP0	6.9998	9.0003	7.742	8.258	13,130	7,764	5.8
*NG075CP0	7.4998	9.5003	8.242	8.758	13,680	7,911	6.1
*NG080CP0	7.9998	10.0003	8.742	9.258	14,770	8,265	6.5
*NG090CP0	8.9998	11.0003	9.742	10.258	16,420	8,743	7.2
*NG100CP0	9.9998	12.0003	10.742	11.258	18,060	9,204	7.9
*NG110CP0	10.9998	13.0003	11.742	12.258	19,700	9,648	8.6
*NG120CP0	11.9998	14.0003	12.742	13.258	21,340	10,074	9.3
*NG140CP0	13.9998	16.0003	14.742	15.258	24,620	10,886	10.8
*NG160CP0	15.9998	18.0003	16.742	17.258	27,910	11,648	12.3
*NG180CP0	17.9998	20.0003	18.742	19.258	31,190	12,367	13.7
*NG200CP0	19.9998	22.0003	20.742	21.258	34,470	13,044	15.8
*NG220CP0	21.9998	24.0003	22.742	23.258	37,757	13,685	16.8
*NG250CP0	24.9998	27.0003	25.742	26.258	42,680	14,591	19.5
*NG300CP0	29.9998	32.0003	30.742	31.258	50,890	15,963	23.3
*NG350CP0	34.9998	37.0003	35.742	36.258	59,100	17,195	27.1
*NG400CP0	39.9998	42.0003	40.742	41.258	67,310	18,307	30.8

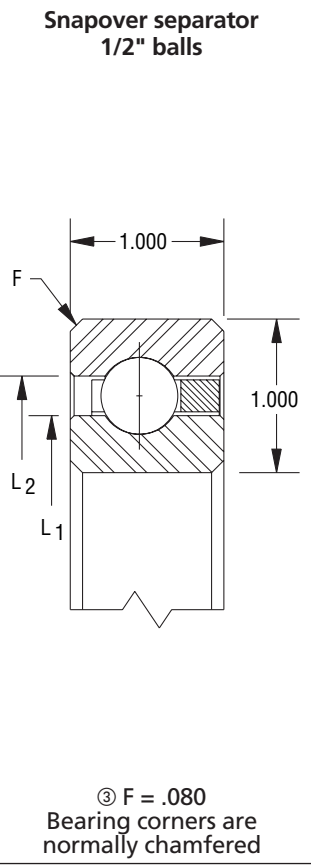

① Capacities listed are not simultaneous. For combined loading see discussion of Bearing Selection and Load Analysis. Dynamic capacities are based upon 1 million revolutions of L10 life. Published capacities do not apply to hybrid series bearings P, X, and Y - contact KAYDON product engineering for values.
 ② Static capacities are non-brinell limits based on rigid support from the shaft and housing.
 ③ "F" is the maximum shaft or housing fillet radius the bearing corners will clear.
 * Contact KAYDON for lead time and minimum purchase requirement.

Open ENDURAKOTE®-PLATED ENDURA-SLIM® Bearing Selections

Type X Four-Point Contact

A Conrad-assembled bearing designed for applications involving multiple loads. Unique internal geometry permits application of radial load, thrust load in either direction, and moment load, individually or in any combination. A single four-point contact bearing may replace two bearings in many applications.

NAA SERIES											
KAYDON Bearing Number	Dimensions in Inches				Capacities ^①						Approx. Weight in Pounds
	Bore	Outside Dia.	Land Dia. L ₁	Land Dia. L ₂	Radial (lbs)		Thrust (lbs)		Moment (in-lbs)		
					Static ^②	Dyn.	Static ^②	Dyn.	Static ^②	Dyn.	
*NAA10XL0	1.0000	1.3752	1.140	1.235	290	247	730	370	170	110	.026
*NAA15XL0	1.5000	1.8752	1.640	1.735	400	296	1,000	460	340	187	.039
*NAA17XL0	1.7500	2.1252	1.890	1.985	460	319	1,140	500	440	232	.045

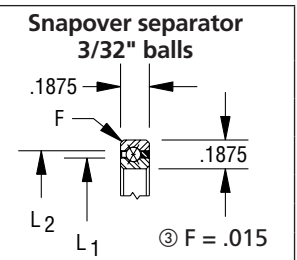

NA SERIES											
KAYDON Bearing Number	Dimensions in Inches				Capacities ^①						Approx. Weight in Pounds
	Bore	Outside Dia.	Land Dia. L ₁	Land Dia. L ₂	Radial (lbs)		Thrust (lbs)		Moment (in-lbs)		
					Static ^②	Dyn.	Static ^②	Dyn.	Static ^②	Dyn.	
*NA020XP0	2.0000	2.5002	2.186	2.314	680	514	1,710	790	770	434	.10
*NA025XP0	2.5000	3.0002	2.686	2.814	830	583	2,090	910	1,150	601	.13
*NA030XP0	3.0000	3.5002	3.186	3.314	990	643	2,470	1,010	1,600	785	.15
*NA035XP0	3.5000	4.0002	3.686	3.814	1,140	701	2,850	1,110	2,130	986	.18
*NA040XP0	3.9998	4.5003	4.186	4.314	1,290	756	3,220	1,210	2,740	1,205	.19
*NA042XP0	4.2498	4.7503	4.436	4.564	1,370	783	3,410	1,260	3,070	1,321	.20
*NA045XP0	4.4998	5.0003	4.686	4.814	1,440	809	3,600	1,310	3,420	1,441	.22
*NA047XP0	4.7498	5.2503	4.936	5.064	1,520	834	3,790	1,350	3,790	1,565	.23
*NA050XP0	4.9998	5.5003	5.186	5.314	1,590	859	3,980	1,400	4,180	1,693	.24
*NA055XP0	5.4998	6.0003	5.686	5.814	1,750	908	4,360	1,480	5,020	1,959	.25
*NA060XP0	5.9998	6.5003	6.186	6.314	1,900	955	4,740	1,570	5,930	2,240	.28
*NA065XP0	6.4998	7.0003	6.686	6.814	2,050	1,001	5,120	1,650	6,910	2,535	.30
*NA070XP0	6.9998	7.5003	7.186	7.314	2,200	1,046	5,500	1,730	7,980	2,844	.31
*NA075XP0	7.4998	8.0003	7.686	7.814	2,350	1,089	5,880	1,810	9,120	3,165	.34
*NA080XP0	7.9998	8.5003	8.186	8.314	2,500	1,131	6,260	1,890	10,330	3,499	.38
*NA090XP0	8.9998	9.5003	9.186	9.314	2,810	1,212	7,020	2,040	12,990	4,204	.44
*NA100XP0	9.9998	10.5003	10.186	10.314	3,110	1,289	7,780	2,180	15,940	4,956	.50
*NA110XP0	10.9998	11.5003	11.186	11.314	3,410	1,362	8,540	2,320	19,210	5,750	.52
*NA120XP0	11.9998	12.5003	12.186	12.314	3,720	1,433	9,300	2,450	22,770	6,587	.56

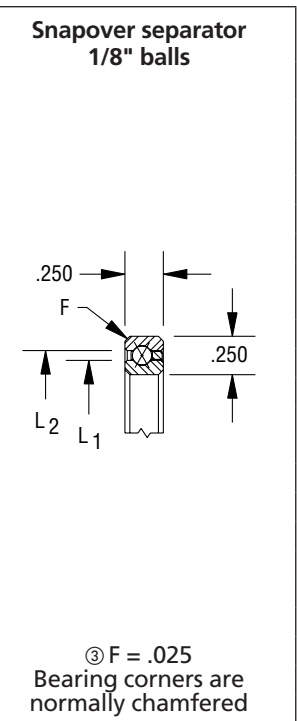

① Capacities listed are not simultaneous. For combined loading see discussion of Bearing Selection and Load Analysis. Dynamic capacities are based upon 1 million revolutions of L10 life. Published capacities do not apply to hybrid series bearings P, X, and Y - contact KAYDON product engineering for values.
 ② Static capacities are non-brinell limits based on rigid support from the shaft and housing.
 ③ "F" is the maximum shaft or housing fillet radius the bearing corners will clear.
 * Contact KAYDON for lead time and minimum purchase requirement.

Open ENDURAKOTE®-PLATED ENDURA-SLIM® Bearings Type X Four-Point Contact

NB SERIES											
KAYDON Bearing Number	Dimensions in Inches				Capacities ^①						Approx. Weight in Pounds
	Bore	Outside Dia.	Land Dia. L ₁	Land Dia. L ₂	Radial (lbs)		Thrust (lbs)		Moment (in-lbs)		
					Static ^②	Dyn.	Static ^②	Dyn.	Static ^②	Dyn.	
*NB020XP0	2.0000	2.6252	2.231	2.393	930	758	2,340	1,130	1,080	658	.16
*NB025XP0	2.5000	3.1252	2.731	2.893	1,140	848	2,840	1,290	1,600	895	.19
*NB030XP0	3.0000	3.6252	3.231	3.393	1,340	933	3,350	1,440	2,220	1,159	.24
*NB035XP0	3.5000	4.1252	3.731	3.893	1,540	1,014	3,860	1,590	2,940	1,450	.27
*NB040XP0	3.9998	4.6253	4.231	4.393	1,750	1,091	4,370	1,720	3,770	1,764	.30
*NB042XP0	4.2498	4.8753	4.481	4.643	1,830	1,120	4,570	1,780	4,170	1,917	.31
*NB045XP0	4.4998	5.1253	4.731	4.893	1,950	1,165	4,880	1,850	4,690	2,103	.33
*NB047XP0	4.7498	5.3753	4.981	5.143	2,030	1,193	5,080	1,900	5,140	2,265	.34
*NB050XP0	4.9998	5.6253	5.231	5.393	2,150	1,236	5,380	1,980	5,720	2,463	.38
*NB055XP0	5.4998	6.1253	5.731	5.893	2,360	1,304	5,890	2,100	6,850	2,844	.41
*NB060XP0	5.9998	6.6253	6.231	6.393	2,560	1,371	6,400	2,220	8,080	3,247	.44
*NB065XP0	6.4998	7.1253	6.731	6.893	2,760	1,435	6,910	2,340	9,410	3,668	.47
*NB070XP0	6.9998	7.6253	7.231	7.393	2,970	1,498	7,420	2,450	10,850	4,109	.50
*NB075XP0	7.4998	8.1253	7.731	7.893	3,170	1,559	7,920	2,560	12,380	4,568	.53
*NB080XP0	7.9998	8.6253	8.231	8.393	3,370	1,618	8,430	2,670	14,020	5,045	.57
*NB090XP0	8.9998	9.6253	9.231	9.393	3,780	1,732	9,450	2,880	17,600	6,050	.66
*NB100XP0	9.9998	10.6253	10.231	10.393	4,190	1,841	10,460	3,080	21,580	7,121	.73
*NB110XP0	10.9998	11.6253	11.231	11.393	4,590	1,945	11,480	3,280	25,970	8,254	.75
*NB120XP0	11.9998	12.6253	12.231	12.393	5,000	2,045	12,500	3,470	30,770	9,446	.83
*NB140XP0	13.9998	14.6253	14.231	14.393	5,810	2,234	14,530	3,840	41,580	11,994	1.05
*NB160XP0	15.9998	16.6253	16.231	16.393	6,620	2,410	16,560	4,190	54,020	14,750	1.20
*NB180XP0	17.9998	18.6253	18.231	18.393	7,440	2,576	18,590	4,520	68,090	17,694	1.35
*NB200XP0	19.9998	20.6253	20.231	20.393	8,250	2,731	20,620	4,850	83,780	20,813	1.50

Snapover separator
5/32" balls

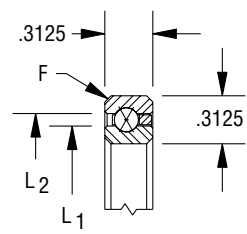

③ F = .040
Bearing corners are normally chamfered

① Capacities listed are not simultaneous. For combined loading see discussion of Bearing Selection and Load Analysis. Dynamic capacities are based upon 1 million revolutions of L10 life. Published capacities do not apply to hybrid series bearings P, X, and Y - contact KAYDON product engineering for values.
 ② Static capacities are non-brinell limits based on rigid support from the shaft and housing.
 ③ "F" is the maximum shaft or housing fillet radius the bearing corners will clear.
 * Contact KAYDON for lead time and minimum purchase requirement.

CONTACT KAYDON AT—
 KAYDON Corporation • Muskegon, Michigan 49443
 Telephone: 231/755-3741 • Fax: 231/759-4102

NEED SERVICE FAST?
1-800-514-3066
 Website: www.kaydonbearings.com

Open ENDURAKOTE®-PLATED ENDURA-SLIM® Bearings Type X Four-Point Contact

NC SERIES											
KAYDON Bearing Number	Dimensions in Inches				Capacities ^①						Approx. Weight in Pounds
	Bore	Outside Dia.	Land Dia. L ₁	Land Dia. L ₂	Radial (lbs)		Thrust (lbs)		Moment (in-lbs)		
					Static ^②	Dyn.	Static ^②	Dyn.	Static ^②	Dyn.	
*NC040XP0	3.9998	4.7503	4.277	4.473	2,100	1,417	5,260	2,210	4,600	2,326	.45
*NC042XP0	4.2498	5.0003	4.527	4.723	2,220	1,464	5,560	2,290	5,140	2,541	.47
*NC045XP0	4.4998	5.2503	4.777	4.973	2,340	1,510	5,860	2,380	5,710	2,762	.48
*NC047XP0	4.7498	5.5003	5.027	5.223	2,460	1,556	6,160	2,460	6,320	2,991	.50
*NC050XP0	4.9998	5.7503	5.277	5.473	2,590	1,600	6,460	2,540	6,950	3,226	.58
*NC055XP0	5.4998	6.2503	5.777	5.973	2,830	1,687	7,060	2,690	8,300	3,717	.59
*NC060XP0	5.9998	6.7503	6.277	6.473	3,070	1,770	7,660	2,840	9,770	4,234	.63
*NC065XP0	6.4998	7.2503	6.777	6.973	3,310	1,851	8,270	2,990	11,370	4,775	.68
*NC070XP0	6.9998	7.7503	7.277	7.473	3,550	1,931	8,870	3,130	13,080	5,341	.73
*NC075XP0	7.4998	8.2503	7.777	7.973	3,790	2,007	9,470	3,270	14,910	5,930	.78
*NC080XP0	7.9998	8.7503	8.277	8.473	4,030	2,082	10,070	3,410	16,870	6,542	.84
*NC090XP0	8.9998	9.7503	9.277	9.473	4,510	2,226	11,270	3,670	21,130	7,830	.94
*NC100XP0	9.9998	10.7503	10.277	10.473	4,990	2,364	12,470	3,930	25,880	9,201	1.06
*NC110XP0	10.9998	11.7503	11.277	11.473	5,470	2,496	13,680	4,180	31,110	10,651	1.16
*NC120XP0	11.9998	12.7503	12.277	12.473	5,950	2,622	14,880	4,420	36,830	12,174	1.25
*NC140XP0	13.9998	14.7503	14.277	14.473	6,910	2,862	17,280	4,890	49,690	15,434	1.52
*NC160XP0	15.9998	16.7503	16.277	16.473	7,880	3,086	19,690	5,330	64,480	18,955	1.73
*NC180XP0	17.9998	18.7503	18.277	18.473	8,840	3,295	22,090	5,760	81,190	22,712	1.94
*NC200XP0	19.9998	20.7503	20.277	20.473	9,800	3,492	24,500	6,170	99,830	26,695	2.16
*NC250XP0	24.9998	25.7503	25.277	25.473	12,200	3,941	30,510	7,140	154,800	37,518	2.69
*NC300XP0	29.9998	30.7503	30.277	30.473	14,610	4,338	36,520	8,050	221,900	49,436	3.21

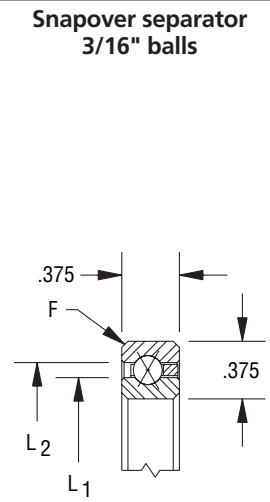

③ F = .040
Bearing corners are normally chamfered

ND SERIES											
KAYDON Bearing Number	Dimensions in Inches				Capacities ^①						Approx. Weight in Pounds
	Bore	Outside Dia.	Land Dia. L ₁	Land Dia. L ₂	Radial (lbs)		Thrust (lbs)		Moment (in-lbs)		
					Static ^②	Dyn.	Static ^②	Dyn.	Static ^②	Dyn.	
*ND040XP0	3.9998	5.0003	4.370	4.630	3,080	2,311	7,700	3,520	6,930	3,901	.78
*ND042XP0	4.2498	5.2503	4.620	4.880	3,190	2,355	7,980	3,600	7,580	4,196	.83
*ND045XP0	4.4998	5.5003	4.870	5.130	3,420	2,454	8,550	3,770	8,550	4,602	.88
*ND047XP0	4.7498	5.7503	5.120	5.380	3,530	2,496	8,840	3,860	9,280	4,916	.94
*ND050XP0	4.9998	6.0003	5.370	5.630	3,760	2,592	9,410	4,020	10,350	5,348	1.00
*ND055XP0	5.4998	6.5003	5.870	6.130	4,100	2,725	10,260	4,260	12,310	6,134	1.06
*ND060XP0	5.9998	7.0003	6.370	6.630	4,450	2,855	11,120	4,490	14,450	6,961	1.16
*ND065XP0	6.4998	7.5003	6.870	7.130	4,790	2,980	11,970	4,720	16,760	7,826	1.22
*ND070XP0	6.9998	8.0003	7.370	7.630	5,130	3,103	12,830	4,940	19,240	8,730	1.31
*ND075XP0	7.4998	8.5003	7.870	8.130	5,470	3,222	13,680	5,160	21,890	9,669	1.41
*ND080XP0	7.9998	9.0003	8.370	8.630	5,810	3,338	14,540	5,370	24,710	10,643	1.53
*ND090XP0	8.9998	10.0003	9.370	9.630	6,500	3,561	16,250	5,790	30,870	12,693	1.72
*ND100XP0	9.9998	11.0003	10.370	10.630	7,180	3,776	17,960	6,190	37,710	14,872	1.88
*ND110XP0	10.9998	12.0003	11.370	11.630	7,870	3,981	19,670	6,570	45,230	17,173	2.06
*ND120XP0	11.9998	13.0003	12.370	12.630	8,550	4,178	21,380	6,950	53,440	19,590	2.25
*ND140XP0	13.9998	15.0003	14.370	14.630	9,920	4,551	24,800	7,670	71,910	24,755	2.73
*ND160XP0	15.9998	17.0003	16.370	16.630	11,290	4,899	28,220	8,360	93,110	30,325	3.10
*ND180XP0	17.9998	19.0003	18.370	18.630	12,650	5,226	31,640	9,030	117,000	36,268	3.48
*ND200XP0	19.9998	21.0003	20.370	20.630	14,020	5,534	35,060	9,670	143,700	42,561	3.85
*ND210XP0	20.9998	22.0003	21.370	21.630	14,710	5,682	36,770	9,980	158,100	45,826	4.04
*ND250XP0	24.9998	26.0003	25.370	25.630	17,440	6,235	43,610	11,180	222,400	59,649	4.79
*ND300XP0	29.9998	31.0003	30.370	30.630	20,860	6,856	52,160	12,600	318,100	78,447	5.73

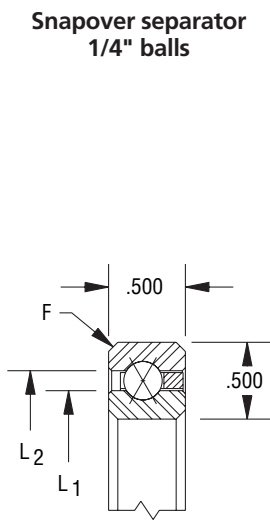

③ F = .060
Bearing corners are normally chamfered

① Capacities listed are not simultaneous. For combined loading see discussion of Bearing Selection and Load Analysis. Dynamic capacities are based upon 1 million revolutions of L10 life. Published capacities do not apply to hybrid series bearings P, X, and Y - contact KAYDON product engineering for values.
 ② Static capacities are non-brinell limits based on rigid support from the shaft and housing.
 ③ "F" is the maximum shaft or housing fillet radius the bearing corners will clear.
 * Contact KAYDON for lead time and minimum purchase requirement.

Open ENDURAKOTE®-PLATED ENDURA-SLIM® Bearings Type X Four-Point Contact

NF SERIES											
KAYDON Bearing Number	Dimensions in Inches				Capacities ^①						Approx. Weight in Pounds
	Bore	Outside Dia.	Land Dia. L ₁	Land Dia. L ₂	Radial (lbs)		Thrust (lbs)		Moment (in-lbs)		
					Static ^②	Dyn.	Static ^②	Dyn.	Static ^②	Dyn.	
*NF040XP0	3.9998	5.5003	4.555	4.945	5,360	4,665	13,400	6,830	12,730	8,312	1.9
*NF042XP0	4.2498	5.7503	4.805	5.195	5,640	4,795	14,110	7,070	14,110	8,993	2.0
*NF045XP0	4.4998	6.0003	5.055	5.445	5,930	4,923	14,810	7,300	15,550	9,695	2.1
*NF047XP0	4.7498	6.2503	5.305	5.695	6,210	5,048	15,520	7,530	17,070	10,416	2.2
*NF050XP0	4.9998	6.5003	5.555	5.945	6,490	5,172	16,220	7,760	18,660	11,157	2.3
*NF055XP0	5.4998	7.0003	6.055	6.445	7,050	5,415	17,630	8,200	22,040	12,696	2.5
*NF060XP0	5.9998	7.5003	6.555	6.945	7,620	5,651	19,050	8,630	25,710	14,311	2.7
*NF065XP0	6.4998	8.0003	7.055	7.445	8,180	5,880	20,460	9,050	29,660	15,993	2.9
*NF070XP0	6.9998	8.5003	7.555	7.945	8,750	6,103	21,870	9,460	33,890	17,744	3.2
*NF075XP0	7.4998	9.0003	8.055	8.445	9,310	6,323	23,280	9,870	38,410	19,568	3.4
*NF080XP0	7.9998	9.5003	8.555	8.945	9,880	6,535	24,690	10,260	43,200	21,453	3.5
*NF090XP0	8.9998	10.5003	9.555	9.945	11,000	6,947	27,510	11,030	53,640	25,410	3.9
*NF100XP0	9.9998	11.5003	10.555	10.945	12,130	7,342	30,330	11,770	65,210	29,608	4.3
*NF110XP0	10.9998	12.5003	11.555	11.945	13,260	7,721	33,150	12,490	77,910	34,032	4.8
*NF120XP0	11.9998	13.5003	12.555	12.945	14,390	8,084	35,970	13,190	91,730	38,666	5.2
*NF140XP0	13.9998	15.5003	14.555	14.945	16,650	8,775	41,620	14,530	122,800	48,556	6.0
*NF160XP0	15.9998	17.5003	16.555	16.945	18,900	9,421	47,260	15,820	158,300	59,200	7.1
*NF180XP0	17.9998	19.5003	18.555	18.945	21,160	10,028	52,900	17,060	198,400	70,537	7.9
*NF200XP0	19.9998	21.5003	20.555	20.945	23,420	10,602	58,550	18,250	243,000	82,528	8.9
*NF250XP0	24.9998	26.5003	25.555	25.945	29,060	11,909	72,650	21,070	374,200	115,037	10.9
*NF300XP0	29.9998	31.5003	30.555	30.945	34,700	13,065	86,760	23,720	533,600	150,708	13.0
*NF350XP0	34.9998	36.5003	35.555	35.945	40,350	14,100	100,900	26,220	721,200	189,106	15.1
*NF400XP0	39.9998	41.5003	40.555	40.945	45,990	15,034	115,000	28,620	937,100	229,832	17.2

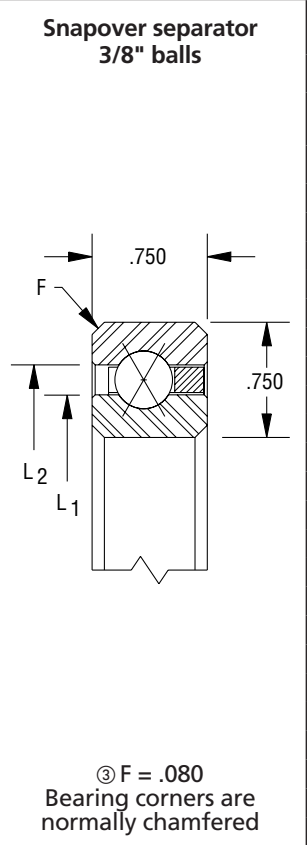

NG SERIES											
KAYDON Bearing Number	Dimensions in Inches				Capacities ^①						Approx. Weight in Pounds
	Bore	Outside Dia.	Land Dia. L ₁	Land Dia. L ₂	Radial (lbs)		Thrust (lbs)		Moment (in-lbs)		
					Static ^②	Dyn.	Static ^②	Dyn.	Static ^②	Dyn.	
*NG040XP0	3.9998	6.0003	4.742	5.258	8,210	7,979	20,520	11,260	20,520	14,966	3.6
*NG042XP0	4.2498	6.2503	4.992	5.508	8,210	7,917	20,520	11,260	21,550	15,592	3.8
*NG045XP0	4.4998	6.5003	5.242	5.758	8,760	8,205	21,890	11,750	24,080	16,930	4.0
*NG047XP0	4.7498	6.7503	5.492	6.008	9,300	8,487	23,260	12,230	26,740	18,306	4.1
*NG050XP0	4.9998	7.0003	5.742	6.258	9,850	8,762	24,620	12,710	29,550	19,721	4.3
*NG055XP0	5.4998	7.5003	6.242	6.758	10,400	8,979	25,990	13,180	33,790	21,896	4.7
*NG060XP0	5.9998	8.0003	6.742	7.258	11,490	9,503	28,730	14,090	40,220	24,956	5.1
*NG065XP0	6.4998	8.5003	7.242	7.758	12,040	9,713	30,100	14,530	45,140	27,327	5.4
*NG070XP0	6.9998	9.0003	7.742	8.258	13,130	10,208	32,830	15,400	52,530	30,636	5.8
*NG075XP0	7.4998	9.5003	8.242	8.758	13,680	10,410	34,200	15,820	58,140	33,196	6.1
*NG080XP0	7.9998	10.0003	8.742	9.258	14,770	10,882	36,940	16,650	66,480	36,743	6.5
*NG090XP0	8.9998	11.0003	9.742	10.258	16,420	11,526	41,040	17,870	82,080	43,240	7.2
*NG100XP0	9.9998	12.0003	10.742	11.258	18,060	12,147	45,140	19,040	99,320	50,124	7.9
*NG110XP0	10.9998	13.0003	11.742	12.258	19,700	12,739	49,250	20,180	118,200	57,347	8.6
*NG120XP0	11.9998	14.0003	12.742	13.258	21,340	13,315	53,350	21,280	138,700	64,935	9.3
*NG140XP0	13.9998	16.0003	14.742	15.258	24,620	14,404	61,560	23,410	184,700	81,056	10.8
*NG160XP0	15.9998	18.0003	16.742	17.258	27,910	15,425	69,770	25,450	237,200	98,373	12.3
*NG180XP0	17.9998	20.0003	18.742	19.258	31,190	16,386	77,980	27,410	296,300	116,793	13.7
*NG200XP0	19.9998	22.0003	20.742	21.258	34,470	17,293	86,180	29,300	362,000	136,238	15.8
*NG220XP0	21.9998	24.0003	22.742	23.258	37,760	18,152	94,390	31,130	434,200	156,625	17.3
*NG250XP0	24.9998	27.0003	25.742	26.258	42,680	19,360	106,700	33,780	554,900	188,838	19.5
*NG300XP0	29.9998	32.0003	30.742	31.258	50,890	21,200	127,200	37,980	788,800	246,541	23.3
*NG350XP0	34.9998	37.0003	35.742	36.258	59,100	22,845	147,700	41,970	1,064,000	308,527	27.1
*NG400XP0	39.9998	42.0003	40.742	41.258	67,310	24,332	168,300	45,770	1,380,000	374,256	30.8

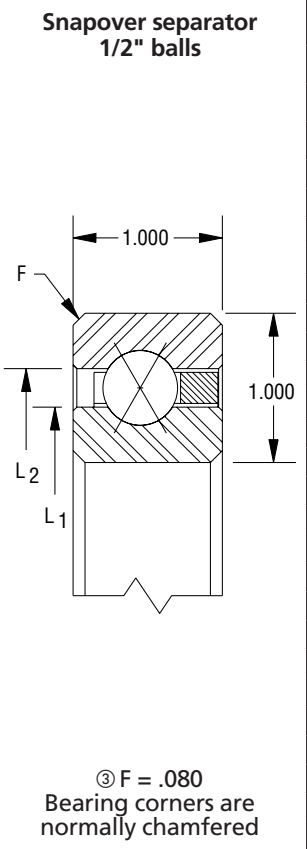

① Capacities listed are not simultaneous. For combined loading see discussion of Bearing Selection and Load Analysis. Dynamic capacities are based upon 1 million revolutions of L10 life. Published capacities do not apply to hybrid series bearings P, X, and Y - contact KAYDON product engineering for values.

② Static capacities are non-brinell limits based on rigid support from the shaft and housing.

③ "F" is the maximum shaft or housing fillet radius the bearing corners will clear.

* Contact KAYDON for lead time and minimum purchase requirement.

Stainless Steel Bearings (Material Code S)

KAYDON stainless steel bearings are used where high precision and corrosion resistance are required.

In today's manufacturing environment, bearings are often required:

- to operate in close proximity to corrosive chemicals
- to operate with lubricants which do not protect against corrosion
- to be ready-to-use, ultra-clean bearings with no preservative on them

Because any of these requirements would disqualify the use of standard 52100 steel material, KAYDON addressed these issues by offering REALI-SLIM® thin-section bearings in AISI 440C stainless steel. This steel meets the minimum 58 HRC hardness level and can support the same loading as does 52100 chrome steel.

All bearings made of this material also utilize balls made of AISI 440C stainless steel.

Stainless Steel REALI-SLIM® thin-section bearings minimize the surface degradation and particulate formation so common in harsh environment applications.

They are available:

- in AISI 440C stainless steel races
- with brass or non-metallic separators
- with either stainless steel or ceramic balls
- in popular sizes
- in either radial contact "C," angular contact "A," or four-point contact "X" configurations



Stainless Steel REALI-SLIM® Bearings

Type A Angular Contact

SAA SERIES (3/16" cross-section)										
KAYDON Bearing Number	Dimensions in Inches					Capacities in Pounds ^①				Approx. Weight in Pounds
	Bore	Outside Dia.	Land Dia. L ₁	Land Dia. L ₂	C'Bore Dia. L ₃	Radial		Thrust		
						Static ^②	Dyn.	Static ^②	Dyn.	
*SAA10AG0	1.000	1.375	1.140	1.235	1.274	340	194	970	450	.025
*SAA15AG0	1.500	1.875	1.640	1.735	1.774	480	238	1,380	560	.038
*SAA17AG0	1.750	2.125	1.890	1.985	2.024	530	251	1,520	600	.045

Circular pocket separator 3/32" balls

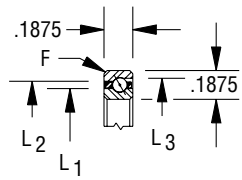

③ F = .015
Bearing corners are normally chamfered

SA SERIES (1/4" cross-section)										
KAYDON Bearing Number	Dimensions in Inches					Capacities in Pounds ^①				Approx. Weight in Pounds
	Bore	Outside Dia.	Land Dia. L ₁	Land Dia. L ₂	C'Bore Dia. L ₃	Radial		Thrust		
						Static ^②	Dyn.	Static ^②	Dyn.	
*SA020AR0	2.000	2.500	2.186	2.314	2.369	790	405	2,280	960	.10
*SA025AR0	2.500	3.000	2.686	2.814	2.869	960	459	2,780	1,100	.12
*SA030AR0	3.000	3.500	3.186	3.314	3.367	1,140	507	3,290	1,230	.14
*SA035AR0	3.500	4.000	3.686	3.814	3.867	1,310	552	3,790	1,350	.17
*SA040AR0	4.000	4.500	4.186	4.314	4.367	1,490	595	4,300	1,470	.19

Circular pocket separator 1/8" balls

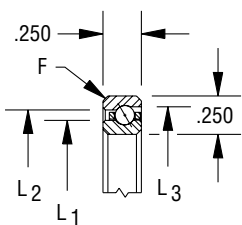

③ F = .025
Bearing corners are normally chamfered

SB SERIES (5/16" cross-section)										
KAYDON Bearing Number	Dimensions in Inches					Capacities in Pounds ^①				Approx. Weight in Pounds
	Bore	Outside Dia.	Land Dia. L ₁	Land Dia. L ₂	C'Bore Dia. L ₃	Radial		Thrust		
						Static ^②	Dyn.	Static ^②	Dyn.	
*SB020AR0	2.000	2.625	2.231	2.393	2.464	1,090	601	3,150	1,380	.15
*SB025AR0	2.500	3.125	2.731	2.893	2.964	1,340	675	3,860	1,590	.19
*SB030AR0	3.000	3.625	3.231	3.393	3.462	1,550	734	4,470	1,750	.22
*SB035AR0	3.500	4.125	3.731	3.893	3.962	1,790	801	5,180	1,930	.27
*SB040AR0	4.000	4.625	4.231	4.393	4.460	2,040	865	5,890	2,100	.30

Circular pocket separator 5/32" balls

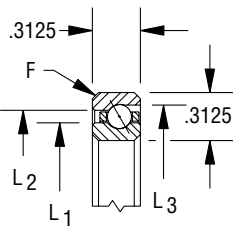

③ F = .040
Bearing corners are normally chamfered

① Capacities listed are not simultaneous. For combined loading see discussion of Bearing Selection and Load Analysis. Dynamic capacities are based upon 1 million revolutions of L10 life. Published capacities do not apply to hybrid series bearings P, X, and Y - contact KAYDON product engineering for values.
 ② Static capacities are non-brinell limits based on rigid support from the shaft and housing.
 ③ "F" is the maximum shaft or housing fillet radius the bearing corners will clear.
 * Contact KAYDON for lead time and minimum purchase requirement.

Stainless Steel REALI-SLIM® Bearings

Type C Radial Contact

SAA SERIES (3/16" cross section)							
KAYDON Bearing Number	Dimensions in Inches				Radial Capacities in Pounds ^①		Approx. Weight in Pounds
	Bore	Outside Dia.	Land Dia. L ₁	Land Dia. L ₂	Static ^②	Dyn.	
*SAA10CLO	1.000	1.375	1.140	1.235	290	188	.026
*SAA15CLO	1.500	1.875	1.640	1.735	400	225	.039
*SAA17CLO	1.750	2.125	1.890	1.985	460	242	.045

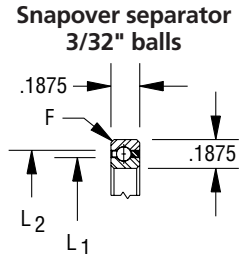

Snapover separator
3/32" balls

③ F = .015
Bearing corners are normally chamfered

SA SERIES (1/4" cross section)							
KAYDON Bearing Number	Dimensions in Inches				Radial Capacities in Pounds ^①		Approx. Weight in Pounds
	Bore	Outside Dia.	Land Dia. L ₁	Land Dia. L ₂	Static ^②	Dyn.	
*SA020CP0	2.000	2.500	2.186	2.314	680	393	.10
*SA025CP0	2.500	3.000	2.686	2.814	830	442	.13
*SA030CP0	3.000	3.500	3.186	3.314	990	487	.15
*SA035CP0	3.500	4.000	3.686	3.814	1,140	530	.18
*SA040CP0	4.000	4.500	4.186	4.314	1,290	571	.19

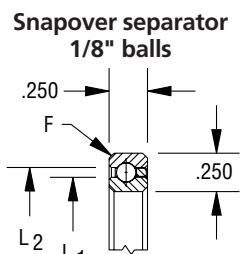

Snapover separator
1/8" balls

③ F = .025
Bearing corners are normally chamfered

SB SERIES (5/16" cross section)							
KAYDON Bearing Number	Dimensions in Inches				Radial Capacities in Pounds ^①		Approx. Weight in Pounds
	Bore	Outside Dia.	Land Dia. L ₁	Land Dia. L ₂	Static ^②	Dyn.	
*SB020CP0	2.000	2.625	2.231	2.393	930	577	.16
*SB025CP0	2.500	3.125	2.731	2.893	1,140	644	.20
*SB030CP0	3.000	3.625	3.231	3.393	1,340	707	.24
*SB035CP0	3.500	4.125	3.731	3.893	1,540	767	.27
*SB040CP0	4.000	4.625	4.231	4.393	1,750	825	.30

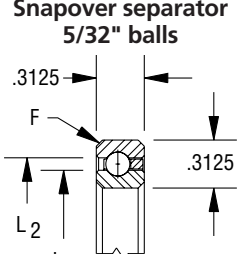

Snapover separator
5/32" balls

③ F = .040
Bearing corners are normally chamfered

① Capacities listed are not simultaneous. For combined loading see discussion of Bearing Selection and Load Analysis. Dynamic capacities are based upon 1 million revolutions of L10 life. Published capacities do not apply to hybrid series bearings P, X, and Y - contact KAYDON product engineering for values.

② Static capacities are non-brinell limits based on rigid support from the shaft and housing.

③ "F" is the maximum shaft or housing fillet radius the bearing corners will clear.

* Contact KAYDON for lead time and minimum purchase requirement.

Stainless Steel REALI-SLIM® Bearings

Type X

Four-Point Contact

SAA SERIES (3/16" cross section)											
KAYDON Bearing Number	Dimensions in Inches				Capacities ^①						Approx. Weight in Pounds
	Bore	Outside Dia.	Land Dia. L ₁	Land Dia. L ₂	Radial (lbs)		Thrust (lbs)		Moment (in-lbs)		
					Static ^②	Dyn.	Static ^②	Dyn.	Static ^②	Dyn.	
*SAA10XL0	1.000	1.375	1.140	1.235	290	247	730	370	170	110	.026
*SAA15XL0	1.500	1.875	1.640	1.735	400	296	1,000	460	340	187	.039
*SAA17XL0	1.750	2.125	1.890	1.985	460	319	1,140	500	440	232	.045

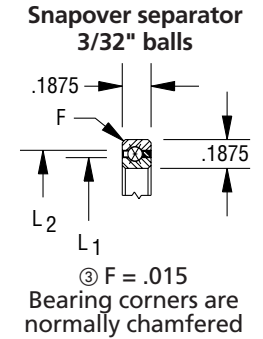

SA SERIES (1/4" cross section)											
KAYDON Bearing Number	Dimensions in Inches				Capacities ^①						Approx. Weight in Pounds
	Bore	Outside Dia.	Land Dia. L ₁	Land Dia. L ₂	Radial (lbs)		Thrust (lbs)		Moment (in-lbs)		
					Static ^②	Dyn.	Static ^②	Dyn.	Static ^②	Dyn.	
*SA020XP0	2.000	2.500	2.186	2.314	680	514	1,710	790	770	434	.10
*SA025XP0	2.500	3.000	2.686	2.814	830	583	2,090	910	1,150	601	.13
*SA030XP0	3.000	3.500	3.186	3.314	990	643	2,470	1,010	1,600	785	.15
*SA035XP0	3.500	4.000	3.686	3.814	1,140	701	2,850	1,110	2,130	986	.18
*SA040XP0	4.000	4.500	4.186	4.314	1,290	756	3,220	1,210	2,740	1,205	.19

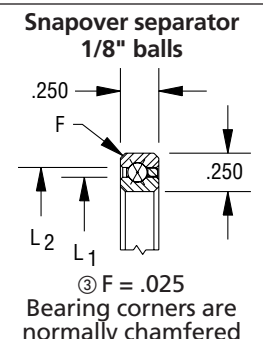

SB SERIES (5/16" cross section)											
KAYDON Bearing Number	Dimensions in Inches				Capacities ^①						Approx. Weight in Pounds
	Bore	Outside Dia.	Land Dia. L ₁	Land Dia. L ₂	Radial (lbs)		Thrust (lbs)		Moment (in-lbs)		
					Static ^②	Dyn.	Static ^②	Dyn.	Static ^②	Dyn.	
*SB020XP0	2.000	2.625	2.231	2.393	930	758	2,340	1,130	1,080	658	.16
*SB025XP0	2.500	3.125	2.731	2.893	1,140	848	2,840	1,290	1,600	895	.19
*SB030XP0	3.000	3.625	3.231	3.393	1,340	933	3,350	1,440	2,220	1,159	.24
*SB035XP0	3.500	4.125	3.731	3.893	1,540	1,014	3,860	1,590	2,940	1,450	.27
*SB040XP0	4.000	4.625	4.231	4.393	1,750	1,091	4,370	1,720	3,770	1,764	.30

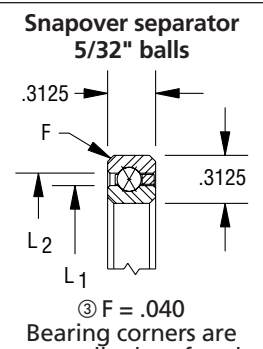

① Capacities listed are not simultaneous. For combined loading see discussion of Bearing Selection and Load Analysis. Dynamic capacities are based upon 1 million revolutions of L10 life. Published capacities do not apply to hybrid series bearings P, X, and Y - contact KAYDON product engineering for values.

② Static capacities are non-brinell limits based on rigid support from the shaft and housing.

③ "F" is the maximum shaft or housing fillet radius the bearing corners will clear.

* Contact KAYDON for lead time and minimum purchase requirement.

REALI-SLIM MM™ Metric Series Bearings

KAYDON created the thin-section bearing standard of the industry in 1954 based on inch sizes. The REALI-SLIM® inch-standard bearing is still the most widely used thin-section bearing in the world.

However, for those applications that require metric envelope dimensions or for dimensional interchangeability with other products, KAYDON offers the REALI-SLIM MM™ series of bearings.

These bearings are offered:

- in cross sections of 8, 13, and 20mm
- with bore diameters ranging from 20mm to 360mm
- with many of the same options found on standard REALI-SLIM® bearings

The REALI-SLIM MM™ series may also be customized for special applications with options such as:

- ceramic balls
- special lubes
- integral seals

Consult KAYDON engineering or your KAYDON representative for details on customization.



Download REALI-DESIGN MM® software from our website www.kaydonbearings.com to obtain specific load/life and other performance data not shown here.

CONTACT KAYDON AT—

KAYDON Corporation • Muskegon, Michigan 49443
Telephone: 231/755-3741 • Fax: 231/759-4102

NEED SERVICE FAST?

1-800-514-3066

Website: www.kaydonbearings.com

REALI-SLIM MM™ Metric Series Bearing Selections

Type A Angular Contact

How to identify REALI-SLIM MM™ Bearings using our part number code:

Standard and optional metric REALI-SLIM® bearings are marked for complete identification with a 9- or 10-digit part number. Positions 1–9 identify materials, size, type, separator type, and precision. Position 10 (optional) identifies non-standard internal fit, either preload or clearance. Custom and proprietary bearings cannot be identified by code, and are marked only with a 9-digit number.

Figure 2-10

Position	1	2	3	4	5	6	7	8	9	10
Nomenclature	Material	Bore (mm)			Width (mm)		Type	Separator	Precision	Internal Fit
Example	K	0	8	0	0	8	X	P	0	K

Explanation of position numbers:

- | | | |
|--|--|--|
| <p>1) J = AISI 52100 steel with Two seals – Nitrile rubber
 K = AISI 52100 steel
 L = AISI 52100 steel and ENDURAKOTE plating
 N = ENDURAKOTE® plating
 S = AISI 440C stainless
 W = AISI 440C Stainless Steel with Two seals – Nitrile rubber</p> | <p>7) = A: Angular contact
 C: Radial contact
 X: Four-point contact</p> <p>8) P = Standard formed ring snap-over type
 R = Standard formed ring circular pocket type</p> <p>9) 0 = Precision Class 1 (ABEC 1F) standard</p> | <p>10) empty = Standard (See page 90)
 A = .0000 to .0127 mm clearance
 K = .0000 to .0127 mm preload
 L = .0000 to .0254 mm preload
 Z = other clearance or preload not specified above</p> |
|--|--|--|

8mm SERIES										
KAYDON Bearing Number	Dimensions					Capacity ^①				Approx. Weight (kg)
	Size (mm)		Land Diameters (mm)			Radial (kg)		Axial (kg)		
	Bore	Outside Dia.	Land Dia. L ₁	Land Dia. L ₂	Land Dia. L ₃	Static ^②	Dyn.	Static ^②	Dyn.	
K02508ARO	25	41	30.9	35.1	37.2	372	272	1073	561	0.06
K05008ARO	50	66	55.9	60.1	62.2	656	367	1894	819	0.08
K06008ARO	60	76	65.9	70.1	72.2	787	408	2273	925	0.09
K07008ARO	70	86	75.9	80.1	82.2	896	440	2588	1009	0.10
K08008ARO	80	96	85.9	90.1	92.2	1006	470	2903	1090	0.12
K09008ARO	90	106	95.9	100.1	102.2	1137	505	3282	1182	0.13
K10008ARO	100	116	105.9	110.1	112.2	1246	533	3598	1257	0.14
K11008ARO	110	126	115.9	120.1	122.2	1356	561	3914	1329	0.15
K12008ARO	120	136	125.9	130.1	132.2	1465	587	4229	1400	0.16
K13008ARO	130	146	135.9	140.1	142.2	1596	618	4608	1482	0.17
K14008ARO	140	156	145.9	150.1	152.2	1706	643	4923	1549	0.18
K15008ARO	150	166	155.9	160.1	162.2	1815	667	5239	1615	0.20
K16008ARO	160	176	165.9	170.1	172.2	1946	696	5618	1691	0.20
K17008ARO	170	186	175.9	180.1	182.1	2055	720	5933	1754	0.21
K18008ARO	180	196	185.9	190.1	192.1	2165	742	6249	1816	0.22
*K19008ARO	190	206	195.9	200.1	202.1	2296	769	6628	1889	0.23
K20008ARO	200	216	205.9	210.1	212.1	2405	791	6944	1948	0.23
K25008ARO	250	266	255.9	260.1	262.1	2974	897	8585	2244	0.28
K30008ARO	300	316	305.9	310.1	312.1	3564	999	10289	2532	0.33
K32008ARO	320	336	325.9	330.1	332.1	3805	1039	10983	2645	0.36
K34008ARO	340	356	345.9	350.1	352.1	4023	1073	11614	2745	0.38
K36008ARO	360	376	365.9	370.1	372.1	4264	1110	12309	2854	0.40

Circular pocket separator 5/32" (inch) balls

Angular Contact Type A

③ F = 0.8
Bearing corners are normally chamfered

① Capacities listed are not simultaneous. For combined loading see discussion of Bearing Selection and Load Analysis. Dynamic capacities are based upon 1 million revolutions of L10 life. Published capacities do not apply to hybrid series bearings P, X, and Y - contact KAYDON product engineering for values.

② Static capacities are non-brinell limits based on rigid support from the shaft and housing.

③ "F" is the maximum shaft or housing fillet radius the bearing corners will clear.

* Contact KAYDON for lead time and minimum purchase requirement. All dimensions in millimeters.

REALI-SLIM MM™ Metric Series Bearing Selections

Type A Angular Contact

13mm SERIES										
KAYDON Bearing Number	Dimensions					Capacity ^①				Approx. Weight (kg)
	Size (mm)		Land Diameters (mm)			Radial (kg)		Axial (kg)		
	Bore	Outside Dia.	Land Dia. L ₁	Land Dia. L ₂	Land Dia. L ₃	Static ^②	Dyn.	Static ^②	Dyn.	
*K02513ARO	25	51	34.7	41.3	44.7	616	554	1778	1075	0.13
*K05013ARO	50	76	59.7	66.3	69.6	1064	725	3070	1547	0.20
*K06013ARO	60	86	69.7	76.3	79.6	1232	782	3555	1706	0.22
K07013ARO	70	96	79.7	86.3	89.6	1456	860	4201	1906	0.25
*K08013ARO	80	106	89.7	96.3	99.6	1623	913	4686	2050	0.28
*K09013ARO	90	116	99.7	106.3	109.6	1791	964	5171	2190	0.31
*K10013ARO	100	126	109.7	116.3	119.6	1959	1013	5656	2324	0.34
*K11013ARO	110	136	119.7	126.3	129.6	2127	1061	6141	2455	0.37
*K12013ARO	120	146	129.7	136.3	139.6	2295	1108	6625	2583	0.39
*K13013ARO	130	156	139.7	146.3	149.6	2519	1171	7272	2748	0.42
*K14013ARO	140	166	149.7	156.3	159.5	2687	1215	7757	2869	0.45
*K15013ARO	150	176	159.7	166.3	169.5	2855	1258	8241	2987	0.48
*K16013ARO	160	186	169.7	176.3	179.5	3023	1301	8726	3104	0.51
K17013ARO	170	196	179.7	186.3	189.5	3191	1342	9211	3217	0.54
*K18013ARO	180	206	189.7	196.3	199.5	3359	1382	9696	3329	0.56
K19013ARO	190	216	199.7	206.3	209.5	3527	1422	10181	3439	0.59
*K20013ARO	200	226	209.7	216.3	219.4	3750	1476	10827	3583	0.62
*K25013ARO	250	276	259.7	266.3	269.4	4590	1659	13251	4100	0.76
*K30013ARO	300	326	309.7	316.3	319.3	5486	1840	15837	4618	0.90
*K32013ARO	320	346	329.7	336.3	339.3	5822	1904	16806	4804	0.96
*K34013ARO	340	366	349.7	356.3	359.2	6213	1978	17937	5017	1.02
*K36013ARO	360	386	369.7	376.3	379.2	6550	2038	18907	5196	1.07

Circular pocket separator
1/4" (inch) balls

Angular Contact Type A

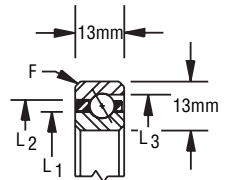

③ F = 1.5
Bearing corners are normally chamfered

20mm SERIES										
KAYDON Bearing Number	Dimensions					Capacity ^①				Approx. Weight (kg)
	Size (mm)		Land Diameters (mm)			Radial (kg)		Axial (kg)		
	Bore	Outside Dia.	Land Dia. L ₁	Land Dia. L ₂	Land Dia. L ₃	Static ^②	Dyn.	Static ^②	Dyn.	
*K02520ARO	25	65	40.0	50.0	55	1134	1155	3272	2115	0.31
*K05020ARO	50	90	65.0	75.0	80	1889	1460	5454	2973	0.49
*K06020ARO	60	100	75.0	85.0	90	2141	1547	6181	3231	0.56
*K07020ARO	70	110	85.0	95.0	100	2393	1633	6908	3480	0.62
*K08020ARO	80	120	95.0	105.0	110	2645	1717	7635	3720	0.69
*K09020ARO	90	130	105.0	115.0	120	3023	1851	8726	4067	0.77
*K10020ARO	100	140	115.0	125.0	130	3275	1929	9453	4290	0.84
*K11020ARO	110	150	125.0	135.0	140	3527	2005	10181	4507	0.91
*K12020ARO	120	160	135.0	145.0	150	3778	2080	10908	4719	0.97
*K13020ARO	130	170	145.0	155.0	160	4030	2154	11635	4927	1.04
*K14020ARO	140	180	155.0	165.0	170	4282	2226	12362	5130	1.11
K15020ARO	150	190	165.0	175.0	180	4660	2339	13453	5427	1.19
K16020ARO	160	200	175.0	185.0	190	4912	2407	14180	5621	1.26
K17020ARO	170	210	185.0	195.0	200	5146	2474	14907	5811	1.32
K18020ARO	180	220	195.0	205.0	210	5416	2540	15634	5999	1.39
*K19020ARO	190	230	205.0	215.0	220	5668	2605	16361	6183	1.46
K20020ARO	200	240	215.0	225.0	230	6045	2706	17452	6455	1.54
K25020ARO	250	290	265.0	275.0	280	7431	3041	21452	7408	1.89
K30020ARO	300	340	315.0	325.0	330	8691	3317	25088	8222	2.23
*K32020ARO	320	360	335.0	345.0	350	9321	3454	26906	8615	2.37
*K34020ARO	340	380	355.0	365.0	370	9824	3556	28360	8923	2.51
*K36020ARO	360	400	375.0	385.0	390	10454	3685	30178	9300	2.66

Circular pocket separator
3/8" (inch) balls

Angular Contact Type A

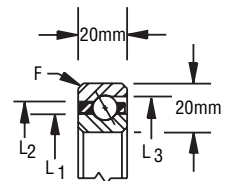

③ F = 1.5
Bearing corners are normally chamfered

① Capacities listed are not simultaneous. For combined loading see discussion of Bearing Selection and Load Analysis. Dynamic capacities are based upon 1 million revolutions of L10 life. Published capacities do not apply to hybrid series bearings P, X, and Y - contact KAYDON product engineering for values.
 ② Static capacities are non-brinell limits based on rigid support from the shaft and housing.
 ③ "F" is the maximum shaft or housing fillet radius the bearing corners will clear.
 * Contact KAYDON for lead time and minimum purchase requirement. All dimensions in millimeters.

REALI-SLIM MM™ Metric Series Bearing Selections

Type C Radial Contact

8mm SERIES								Snapover separator 5/32" (inch) balls
KAYDON Bearing Number	Dimensions				Capacity ^①		Approx. Weight (kg)	
	Size (mm)		Land Diameters (mm)		Radial (kg)			
	Bore	Outside Dia.	Land Dia. L ₁	Land Dia. L ₂	Static ^②	Dynamic		
K02508CP0	25	41	30.9	35.1	303	255	0.06	
K05008CP0	50	66	55.9	60.1	556	350	0.08	
K06008CP0	60	76	65.9	70.1	656	384	0.09	
K07008CP0	70	86	75.9	80.1	758	417	0.10	
K08008CP0	80	96	85.9	90.1	859	448	0.11	
K09008CP0	90	106	95.9	100.1	959	478	0.13	
K10008CP0	100	116	105.9	110.1	1061	507	0.14	
K11008CP0	110	126	115.9	120.1	1162	534	0.15	
K12008CP0	120	136	125.9	130.1	1262	561	0.16	
K13008CP0	130	146	135.9	140.1	1364	588	0.17	
K14008CP0	140	156	145.9	150.1	1465	613	0.18	
K15008CP0	150	166	155.9	160.1	1565	638	0.20	
K16008CP0	160	176	165.9	170.1	1666	662	0.20	
K17008CP0	170	186	175.9	180.1	1767	686	0.20	
K18008CP0	180	196	185.9	190.1	1868	709	0.21	
*K19008CP0	190	206	195.9	200.1	1944	725	0.21	
K20008CP0	200	216	205.9	210.1	2045	748	0.22	
K25008CP0	250	266	255.9	260.1	2550	853	0.28	
K30008CP0	300	316	305.9	310.1	3055	949	0.35	
K32008CP0	320	336	325.9	330.1	3257	985	0.39	
K34008CP0	340	356	345.9	350.1	3459	1016	0.42	
K36008CP0	360	376	365.9	370.1	3636	1050	0.46	

**Conrad
Assembly
Type C**

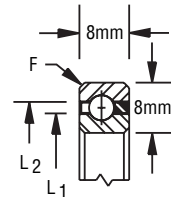

③ F = 0.8
Bearing corners are normally chamfered

8mm SERIES (DOUBLE SEALED)										Snapover separator 5/32" (inch) balls
KAYDON Bearing Number	Dimensions				Capacity ^①		Limiting Speeds (RPM)	Torque Max. No Load (N-m)	Approx. Weight (kg)	
	Size (mm)		Land Diameters (mm)		Radial (kg)					
	Bore	Outside Dia.	Land Dia. L ₁	Land Dia. L ₂	Static ^②	Dynamic				
*J02508CP0	25	41	31.55	34.42	303	255	5580	0.02	0.06	
*J05008CP0	50	66	56.55	59.42	556	350	3180	0.04	0.08	
*J06008CP0	60	76	66.55	69.42	656	384	2710	0.05	0.09	
*J07008CP0	70	86	76.55	79.42	758	417	2360	0.07	0.10	
*J08008CP0	80	96	86.55	89.42	859	448	2090	0.09	0.11	
*J09008CP0	90	106	96.55	99.42	959	478	1880	0.12	0.13	
*J10008CP0	100	116	106.55	109.42	1061	507	1700	0.15	0.14	
*J11008CP0	110	126	116.55	119.42	1162	534	1560	0.18	0.15	
*J12008CP0	120	136	126.55	129.42	1262	561	1440	0.22	0.16	
*J13008CP0	130	146	136.55	139.42	1364	588	1330	0.26	0.17	
*J14008CP0	140	156	146.55	149.42	1465	613	1240	0.30	0.18	
*J15008CP0	150	166	156.55	159.42	1565	638	1160	0.35	0.20	
*J16008CP0	160	176	166.55	169.42	1666	662	1090	0.40	0.20	
*J17008CP0	170	186	176.55	179.42	1767	686	1030	0.46	0.20	

**Conrad
Assembly
Type C**

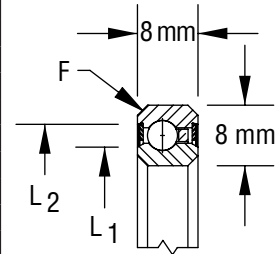

③ F = 0.8
Bearing corners are normally chamfered

① Capacities listed are not simultaneous. For combined loading see discussion of Bearing Selection and Load Analysis. Dynamic capacities are based upon 1 million revolutions of L10 life. Published capacities do not apply to hybrid series bearings P, X, and Y - contact KAYDON product engineering for values.
 ② Static capacities are non-brinell limits based on rigid support from the shaft and housing.
 ③ "F" is the maximum shaft or housing fillet radius the bearing corners will clear.
 ④ Torque figures shown are for single bearings with standard lubricant at room temperature and under 5 pounds thrust load.
 ** Values apply to bearings loaded up to 20% of their dynamic capacity.
 * Contact KAYDON for lead time and minimum purchase requirement.

REALI-SLIM MM™ Metric Series Bearing Selections

Type C Radial Contact

13mm SERIES								Snapover separator 1/4" (inch) balls
KAYDON Bearing Number	Dimensions				Capacity ^①		Approx. Weight (kg)	
	Size (mm)		Land Diameters (mm)		Radial (kg)			
	Bore	Outside Dia.	Land Dia. L ₁	Land Dia. L ₂	Static ^②	Dynamic		
*K02513CP0	25	51	34.7	41.3	517	535	0.11	
*K05013CP0	50	76	59.7	66.3	905	697	0.18	
*K06013CP0	60	86	69.7	76.3	1099	775	0.21	
K07013CP0	70	96	79.7	86.3	1228	819	0.24	
*K08013CP0	80	106	89.7	96.3	1358	862	0.26	
*K09013CP0	90	116	99.7	106.3	1551	931	0.29	
*K10013CP0	100	126	109.7	116.3	1681	971	0.32	
*K11013CP0	110	136	119.7	126.3	1875	1035	0.35	
*K12013CP0	120	146	129.7	136.3	2004	1073	0.38	
*K13013CP0	130	156	139.7	146.3	2133	1110	0.41	
*K14013CP0	140	166	149.7	156.3	2327	1169	0.44	
*K15013CP0	150	176	159.7	166.3	2456	1204	0.46	
*K16013CP0	160	186	169.7	176.3	2586	1239	0.49	
K17013CP0	170	196	179.7	186.3	2780	1294	0.52	
*K18013CP0	180	206	189.7	196.3	2909	1327	0.55	
K19013CP0	190	216	199.7	206.3	3038	1360	0.58	
*K20013CP0	200	226	209.7	216.3	3232	1411	0.61	
*K25013CP0	250	276	259.7	266.3	4008	1598	0.75	
*K30013CP0	300	326	309.7	316.3	4719	1754	0.89	
*K32013CP0	320	346	329.7	336.3	5042	1823	0.95	
*K34013CP0	340	366	349.7	356.3	5365	1889	1.01	
*K36013CP0	360	386	369.7	376.3	5688	1954	1.06	

**Conrad
Assembly
Type C**

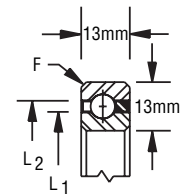

③ F = 1.5
Bearing corners are normally chamfered

20mm SERIES								Snapover separator 3/8" (inch) balls
KAYDON Bearing Number	Dimensions				Capacity ^①		Approx. Weight (kg)	
	Size (mm)		Land Diameters (mm)		Radial (kg)			
	Bore	Outside Dia.	Land Dia. L ₁	Land Dia. L ₂	Static ^②	Dynamic		
*K02520CP0	25	65	40.0	50.0	1018	1178	0.34	
*K05020CP0	50	90	65.0	75.0	1600	1410	0.51	
*K06020CP0	60	100	75.0	85.0	1745	1452	0.58	
*K07020CP0	70	110	85.0	95.0	2036	1573	0.65	
*K08020CP0	80	120	95.0	105.0	2181	1617	0.72	
*K09020CP0	90	130	105.0	115.0	2473	1730	0.80	
*K10020CP0	100	140	115.0	125.0	2618	1773	0.86	
*K11020CP0	110	150	125.0	135.0	2909	1880	0.94	
*K12020CP0	120	160	135.0	145.0	3200	1982	1.01	
*K13020CP0	130	170	145.0	155.0	3345	2023	1.08	
*K14020CP0	140	180	155.0	165.0	3636	2121	1.15	
K15020CP0	150	190	165.0	175.0	3781	2161	1.20	
K16020CP0	160	200	175.0	185.0	4072	2254	1.30	
K17020CP0	170	210	185.0	195.0	4363	2293	1.40	
K18020CP0	180	220	195.0	205.0	4508	2383	1.50	
*K19020CP0	190	230	205.0	215.0	4800	2470	1.50	
K20020CP0	200	240	215.0	225.0	4945	2507	1.60	
K25020CP0	250	290	265.0	275.0	6108	2821	2.10	
K30020CP0	300	340	315.0	325.0	7272	3111	2.30	
*K32020CP0	320	360	335.0	345.0	7708	3213	2.42	
*K34020CP0	340	380	355.0	365.0	8144	3312	2.54	
*K36020CP0	360	400	375.0	385.0	8581	3408	2.70	

**Conrad
Assembly
Type C**

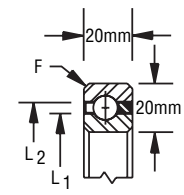

③ F = 1.5
Bearing corners are normally chamfered

① Capacities listed are not simultaneous. For combined loading see discussion of Bearing Selection and Load Analysis. Dynamic capacities are based upon 1 million revolutions of L10 life. Published capacities do not apply to hybrid series bearings P, X, and Y - contact KAYDON product engineering for values.
 ② Static capacities are non-brinell limits based on rigid support from the shaft and housing.
 ③ "F" is the maximum shaft or housing fillet radius the bearing corners will clear.
 * Contact KAYDON for lead time and minimum purchase requirement. All dimensions in millimeters.

REALI-SLIM MM™ Metric Series Bearing Selections

Type X Four-Point Contact

8mm SERIES											
KAYDON Bearing Number	Dimensions				Capacity ^①						Approx. Weight (kg)
	Size (mm)		Land Diameters (mm)		Radial (kg)		Axial (kg)		Moment (N-m)		
	Bore	Outside Dia.	Land Dia. L ₁	Land Dia. L ₂	Static ^②	Dyn.	Static ^②	Dyn.	Static ^②	Dyn.	
K02508XP0	25	41	30.9	35.1	334	331	758	469	49	40	0.06
K05008XP0	50	66	55.9	60.1	555	460	1389	666	158	98	0.08
K06008XP0	60	76	65.9	70.1	656	506	1641	745	219	127	0.09
K07008XP0	70	86	75.9	80.1	757	549	1894	819	290	158	0.10
K08008XP0	80	96	85.9	90.1	859	591	2146	890	370	191	0.11
K09008XP0	90	106	95.9	100.1	959	631	2399	959	461	228	0.13
K10008XP0	100	116	105.9	110.1	1060	670	2651	1025	562	266	0.14
K11008XP0	110	126	115.9	120.1	1162	707	2903	1090	672	307	0.15
K12008XP0	120	136	125.9	130.1	1262	743	3156	1152	792	350	0.16
K13008XP0	130	146	135.9	140.1	1363	778	3409	1212	923	395	0.18
K14008XP0	140	156	145.9	150.1	1465	812	3661	1271	1063	442	0.19
K15008XP0	150	166	155.9	160.1	1565	846	3914	1329	1213	492	0.20
K16008XP0	160	176	165.9	170.1	1666	878	4166	1386	1373	543	0.20
K17008XP0	170	186	175.9	180.1	1767	910	4418	1441	1543	596	0.20
K18008XP0	180	196	185.9	190.1	1868	941	4671	1495	1722	651	0.21
*K19008XP0	190	206	195.9	200.1	1944	963	4860	1536	1888	701	0.21
K20008XP0	200	216	205.9	210.1	2045	992	5113	1588	2086	759	0.22
K25008XP0	250	266	255.9	260.1	2550	1133	6375	1840	3226	1075	0.28
K30008XP0	300	316	305.9	310.1	3055	1261	7638	2076	4614	1429	0.35
K32008XP0	320	336	325.9	330.1	3257	1310	8143	2166	5238	1580	0.39
K34008XP0	340	356	345.9	350.1	3459	1350	8648	2255	5859	1728	0.42
K36008XP0	360	376	365.9	370.1	3636	1396	9089	2330	6561	1890	0.46

Snapover separator
5/32" (inch) balls

4 Point Contact Type X

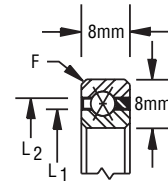

③ F = 0.8
Bearing corners are normally chamfered

8mm SERIES (DOUBLE SEALED)													
KAYDON Bearing Number	Dimensions				Capacity ^①						Limiting Speeds (RPM)	Torque Max. No Load (N-m)	Approx. Weight (kg)
	Size (mm)		Land Diameters (mm)		Radial (kg)		Axial (kg)		Moment (N-m)				
	Bore	Outside Dia.	Land Dia. L ₁	Land Dia. L ₂	Static ^②	Dyn.	Static ^②	Dyn.	Static ^②	Dyn.			
*J02508XP0	25	41	31.55	34.42	334	331	758	469	49	40	3000	0.02	0.06
*J05008XP0	50	66	56.55	59.42	555	460	1389	666	158	98	1500	0.04	0.08
*J06008XP0	60	76	66.55	69.42	656	506	1641	745	219	127	1270	0.05	0.09
*J07008XP0	70	86	76.55	79.42	757	549	1894	819	290	158	1090	0.07	0.10
*J08008XP0	80	96	86.55	89.42	859	591	2146	890	370	191	950	0.09	0.11
*J09008XP0	90	106	96.55	99.42	959	631	2399	959	461	228	700	0.12	0.13
*J10008XP0	100	116	106.55	109.42	1060	670	2651	1025	562	266	630	0.15	0.14
*J11008XP0	110	126	116.55	119.42	1162	707	2903	1090	672	307	580	0.18	0.15
*J12008XP0	120	136	126.55	129.42	1262	743	3156	1152	792	350	530	0.22	0.16
*J13008XP0	130	146	136.55	139.42	1363	778	3409	1212	923	395	490	0.26	0.18
*J14008XP0	140	156	146.55	149.42	1465	812	3661	1271	1063	442	450	0.30	0.19
*J15008XP0	150	166	156.55	159.42	1565	846	3914	1329	1213	492	420	0.35	0.20
*J16008XP0	160	176	166.55	169.42	1666	878	4166	1386	1373	543	400	0.40	0.20
*J17008XP0	170	186	176.55	179.42	1767	910	4418	1441	1543	596	370	0.46	0.20

Snapover separator
5/32" (inch) balls

4 Point Contact Type X

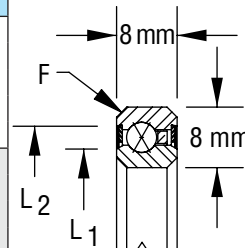

③ F = 0.8
Bearing corners are normally chamfered

① Capacities listed are not simultaneous. For combined loading see discussion of Bearing Selection and Load Analysis. Dynamic capacities are based upon 1 million revolutions of L10 life. Published capacities do not apply to hybrid series bearings P, X, and Y - contact KAYDON product engineering for values.
 ② Static capacities are non-brinell limits based on rigid support from the shaft and housing.
 ③ "F" is the maximum shaft or housing fillet radius the bearing corners will clear.
 ④ Torque figures shown are for single bearings with standard lubricant at room temperature and under 5 pounds thrust load.
 ** Values apply to bearings loaded up to 20% of their dynamic capacity.
 * Contact KAYDON for lead time and minimum purchase requirement.

REALI-SLIM MM™ Metric Series Bearing Selections

Type X Four-Point Contact

13mm SERIES											
KAYDON Bearing Number	Dimensions				Capacity ^①						Approx. Weight (kg)
	Size (mm)		Land Diameters (mm)		Radial (kg)		Axial (kg)		Moment (N-m)		
	Bore	Outside Dia.	Land Dia. L ₁	Land Dia. L ₂	Static ^②	Dyn.	Static ^②	Dyn.	Static ^②	Dyn.	
*K02513XP0	25	51	34.7	41.3	696	689	1293	869	96	96	0.13
*K05013XP0	50	76	59.7	66.3	919	910	2263	1226	280	211	0.20
*K06013XP0	60	86	69.7	76.3	1099	1014	2747	1436	393	272	0.23
*K07013XP0	70	96	79.7	86.3	1228	1074	3070	1547	500	328	0.26
*K08013XP0	80	106	89.7	96.3	1358	1133	3393	1653	619	388	0.28
*K09013XP0	90	116	99.7	106.3	1551	1224	3878	1808	784	464	0.31
*K10013XP0	100	126	109.7	116.3	1681	1279	4201	1906	931	532	0.34
*K11013XP0	110	136	119.7	126.3	1875	1364	4686	2050	1131	617	0.37
*K12013XP0	120	146	129.7	136.3	2006	1415	5010	2144	1307	693	0.40
*K13013XP0	130	156	139.7	146.3	2133	1466	5333	2235	1496	771	0.43
*K14013XP0	140	166	149.7	156.3	2327	1544	5817	2368	1746	869	0.46
*K15013XP0	150	176	159.7	166.3	2456	1592	6141	2455	1963	954	0.48
*K16013XP0	160	186	169.7	176.3	2586	1639	6464	2541	2193	1043	0.51
*K17013XP0	170	196	179.7	186.3	2780	1711	6949	2666	2494	1152	0.54
*K18013XP0	180	206	189.7	196.3	2909	1756	7272	2748	2753	1247	0.57
K19013XP0	190	216	199.7	206.3	3038	1800	7595	2829	3024	1344	0.60
*K20013XP0	200	226	209.7	216.3	3232	1868	8080	2948	3375	1464	0.63
*K25013XP0	250	276	259.7	266.3	4008	2119	10019	3403	5168	2050	0.77
*K30013XP0	300	326	309.7	316.3	4719	2327	11796	3794	7242	2680	0.91
*K32013XP0	320	346	329.7	336.3	5042	2419	12605	3966	8232	2963	0.97
*K34013XP0	340	366	349.7	356.3	5365	2508	13412	4133	9286	3257	1.02
*K36013XP0	360	386	369.7	376.3	5688	2594	14220	4298	10403	3560	1.08

Snapover separator
1/4" (inch) balls

4 Point Contact Type X

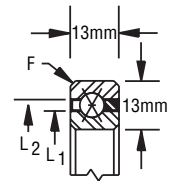

③ F = 1.5
Bearing corners are normally chamfered

20mm SERIES											
KAYDON Bearing Number	Dimensions				Capacity ^①						Approx. Weight (kg)
	Size (mm)		Land Diameters (mm)		Radial (kg)		Axial (kg)		Moment (N-m)		
	Bore	Outside Dia.	Land Dia. L ₁	Land Dia. L ₂	Static ^②	Dyn.	Static ^②	Dyn.	Static ^②	Dyn.	
*K02520XP0	25	65	40.0	50.0	1518	1503	2545	1789	225	225	0.34
*K05020XP0	50	90	65.0	75.0	1845	1827	3999	2418	549	470	0.52
*K06020XP0	60	100	75.0	85.0	1906	1887	4363	2562	685	556	0.59
*K07020XP0	70	110	85.0	95.0	2071	2050	5090	2839	899	679	0.66
*K08020XP0	80	120	95.0	105.0	2181	2111	5454	2973	1070	777	0.73
*K09020XP0	90	130	105.0	115.0	2473	2263	6181	3231	1334	916	0.80
*K10020XP0	100	140	115.0	125.0	2618	2323	6545	3357	1540	1026	0.87
*K11020XP0	110	150	125.0	135.0	2909	2466	7272	3601	1854	1179	0.94
*K12020XP0	120	160	135.0	145.0	3200	2603	7999	3837	2196	1341	1.01
*K13020XP0	130	170	145.0	155.0	3345	2660	8363	3953	2460	1468	1.07
*K14020XP0	140	180	155.0	165.0	3636	2791	9090	4179	2852	1643	1.15
K15020XP0	150	190	165.0	175.0	3781	2845	9453	4290	3152	1779	1.22
K16020XP0	160	200	175.0	185.0	4072	2970	10180	4507	3594	1967	1.30
K17020XP0	170	210	185.0	195.0	4363	3023	10907	4719	3929	2113	1.37
K18020XP0	180	220	195.0	205.0	4508	3143	11271	4823	4421	2312	1.44
*K19020XP0	190	230	205.0	215.0	4800	3260	11999	5029	4942	2519	1.51
K20020XP0	200	240	215.0	225.0	4945	3309	12362	5130	5334	2678	1.57
K25020XP0	250	290	265.0	275.0	6108	3731	15271	5906	8087	3706	2.10
K30020XP0	300	340	315.0	325.0	7272	4119	18179	6633	11410	4849	2.30
*K32020XP0	320	360	335.0	345.0	7708	4255	19270	6897	12850	5323	2.44
*K34020XP0	340	380	355.0	365.0	8144	4388	20361	7154	14376	5812	2.58
*K36020XP0	360	400	375.0	385.0	8581	4518	21452	7408	15988	6316	2.73

Snapover separator
3/8" (inch) balls

4 Point Contact Type X

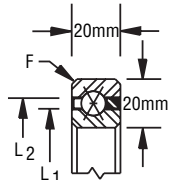

③ F = 1.5
Bearing corners are normally chamfered

① Capacities listed are not simultaneous. For combined loading see discussion of Bearing Selection and Load Analysis. Dynamic capacities are based upon 1 million revolutions of L10 life. Published capacities do not apply to hybrid series bearings P, X, and Y - contact KAYDON product engineering for values.

② Static capacities are non-brinell limits based on rigid support from the shaft and housing.

③ "F" is the maximum shaft or housing fillet radius the bearing corners will clear.

* Contact KAYDON for lead time and minimum purchase requirement. All dimensions in millimeters.

ULTRA-SLIM® Thin-Section Bearings

Ideal for applications in robotics, inspection equipment, satellites, cameras... anywhere precise positioning and lightweight designs are critical.

At just 2.5 mm wide, ULTRA-SLIM® bearings are available in bore sizes ranging from 35 mm to 170 mm for an array of applications. Their compact profile allows you to use ULTRA-SLIM® bearings in many highly confined spaces.

Precision-engineered ULTRA-SLIM® bearings are made of stainless steel for corrosion resistance. They are available in angular contact (Type A), radial contact (Type C), and four-point contact (Type X) styles. (See selection charts at right.)

Hybrid bearings with ceramic balls are available upon request. These configurations are used often when lubrication is marginal or when lower wear generation and/or lower torque levels are required.

Figure 2-11

How to identify ULTRA-SLIM® Bearings using our part number code

Position	1	2	3	4	5	6	7	8	9	10
Nomenclature	Material	Bore (mm)			Width(mm)		Type	Separator	Precision	Internal Fit
Example	S	1	1	0	0	3	C	S	0	K

Explanation of position numbers:

Position 1—Material

S = AISI 440C races and balls
(Standard for Series)

Positions 2, 3 and 4—Bore

Nominal bearing bore in mm.

Positions 5 and 6—Width

Nominal radial race width in mm.

Position 7—Bearing Type

A = Angular Contact
C = Radial Contact
X = Four-Point Contact

Position 8—Separator

S = Spacer balls
F = Full complement of load balls

Position 9—Precision

0 = KAYDON standard precision class

Position 10—Internal Fit

A = 0.000 - 0.013 mm clearance
C = 0.013 - 0.025 mm clearance
E = 0.025 - 0.051 mm clearance
K = 0.000 - 0.013 mm preload
M = 0.013 - 0.025 mm preload
empty = standard internal fitup if not specified

Performance and Application Considerations

ULTRA-SLIM® bearings are unique in that their extremely thin cross section enables them to provide great size and weight reductions for light to medium duty applications with slow or intermittent rotation.

Given the fact that these bearings will most likely be used in lightly loaded applications where saving weight and space are the main objective, the loading values shown assume that the shaft and housing will also be of light construction. This will allow for greater bearing ring movement under load than traditional heavy section bearings. Thus the *loading limits* for capacity are not based on ABMA standards.

Depending on the support provided by the shaft and housing, this movement can create increased stress levels within the bearing. Distortion of the shaft and housing under load will transfer to the bearing, causing increased stress levels which could lead to premature failure and/or erratic torque conditions.

The impact of non-uniform shaft and housing distortions is best found by testing. If problems are experienced, increased rigidity of the shaft and housing may be necessary. If the shaft and housing are of sufficient rigidity, it may be possible for the bearings to support greater loads than the loading limits provided.

ULTRA-SLIM® Bearing Selection Data

Angular Contact Type A								
KAYDON Bearing Number	Dimensions in mm				Capacity		Loading Limits	Mass in Grams
	Bore	Outside Diameter	Land Dia. L ₁	Land Dia. L ₂	Radial Newtons		Thrust Newtons ^③	
					Static ^①	Dyn. ^②		
*S03503AS0	35	41	37.2	38.8	382	383	1334	5
*S06003AS0	60	66	62.2	63.8	649	552	1112	9
*S07003AS0	70	76	72.2	73.8	756	609	1068	11
*S07403AS0	74	80	76.2	77.8	799	632	1045	11
*S08003AS0	80	86	82.2	83.8	863	663	1001	12
*S09003AS0	90	96	92.2	93.8	970	716	956	13
*S10003AS0	100	106	102.2	103.8	1077	765	890	15
*S11003AS0	110	116	112.2	113.8	1183	814	867	16
*S12003AS0	120	126	122.2	123.8	1290	863	823	18
*S13003AS0	130	136	132.2	133.8	1407	912	778	19
*S14003AS0	140	146	142.2	143.8	1514	956	734	21
*S15003AS0	150	156	152.2	153.8	1621	1001	712	22
*S16003AS0	160	166	162.2	163.8	1727	1045	689	24
*S17003AS0	170	176	172.2	173.8	1834	1085	667	25

Full complement or ball spacer ball 1/16" (inch)

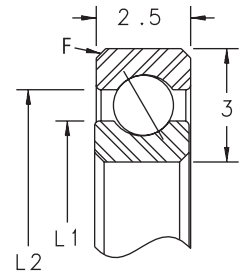

④ F = 0.25
Bearing corners are normally chamfered

Radial Contact Type C							
KAYDON Bearing Number	Dimensions in mm				Capacity		Mass in Grams
	Bore	Outside Diameter	Land Dia. L ₁	Land Dia. L ₂	Radial Newtons		
					Static ^①	Dyn. ^②	
*S03503CS0	35	41	37.2	38.8	418	418	5
*S06003CS0	60	66	62.2	63.8	711	605	9
*S07003CS0	70	76	72.2	73.8	827	667	11
*S07403CS0	74	80	76.2	77.8	875	689	11
*S08003CS0	80	86	82.2	83.8	944	725	12
*S09003CS0	90	96	92.2	93.8	1062	783	13
*S10003CS0	100	106	102.2	103.8	1178	841	15
*S11003CS0	110	116	112.2	113.8	1295	894	16
*S12003CS0	120	126	122.2	123.8	1412	943	18
*S13003CS0	130	136	132.2	133.8	1540	1001	19
*S14003CS0	140	146	142.2	143.8	1658	1050	21
*S15003CS0	150	156	152.2	153.8	1774	1099	22
*S16003CS0	160	166	162.2	163.8	1891	1143	24
*S17003CS0	170	176	172.2	173.8	2006	1192	25

Full complement or ball spacer ball 1/16" (inch)

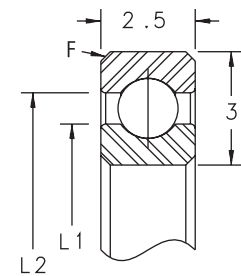

④ F = 0.25
Bearing corners are normally chamfered

4-Point Contact Type X									
KAYDON Bearing Number	Dimensions in mm				Capacity		Loading Limits		Mass in Grams
	Bore	Outside Diameter	Land Dia. L ₁	Land Dia. L ₂	Radial Newtons		Thrust Newtons ^③	Moment N-m ^④	
					Static ^①	Dyn. ^②			
*S03503XS0	35	41	37.2	38.8	711	585	1045	7.9	5
*S06003XS0	60	66	62.2	63.8	1208	847	934	11.8	9
*S07003XS0	70	76	72.2	73.8	1407	934	890	13.0	11
*S07403XS0	74	80	76.2	77.8	1487	965	867	13.4	11
*S08003XS0	80	86	82.2	83.8	1606	1015	845	14.0	12
*S09003XS0	90	96	92.2	93.8	1805	1096	801	14.9	13
*S10003XS0	100	106	102.2	103.8	2003	1177	756	15.6	15
*S11003XS0	110	116	112.2	113.8	2201	1252	734	16.6	16
*S12003XS0	120	126	122.2	123.8	2400	1320	689	17.0	18
*S13003XS0	130	136	132.2	133.8	2618	1401	645	17.2	19
*S14003XS0	140	146	142.2	143.8	2818	1470	623	17.8	21
*S15003XS0	150	156	152.2	153.8	3016	1538	601	18.4	22
*S16003XS0	160	166	162.2	163.8	3215	1600	578	18.9	24
*S17003XS0	170	176	172.2	173.8	3413	1669	556	19.2	25

Full complement or ball spacer ball 1/16" (inch)

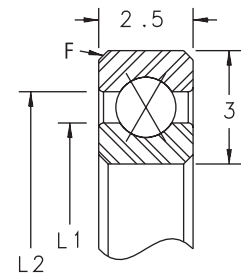

④ F = 0.25
Bearing corners are normally chamfered

① Static radial capacities are based on maximum allowable contact stresses. Adequate support of the races is assumed to help assure uniform ball support.
 ② Dynamic radial capacities are included for life calculation purposes. These are based on the assumption that the shaft and housing have adequate strength to support the loads without causing excessive distortion of the bearing rings.
 ③ Higher loading limits may be achieved with sufficiently rigid supports that will better restrict the movement of the bearing races under load.
 ④ Corner size is the maximum shaft or housing fillet radius that the bearing corners will clear.
 *Contact KAYDON for lead time and minimum purchase requirement.

Only from KAYDON®: REALI-SLIM TT® Series — the new generation of small-scale, thin-section turntable bearings

To save weight, reduce product design envelope sizes and increase design flexibility — without compromising bearing performance and life — customers told us they'd welcome a more compact turntable bearing design.

We listened and responded, by designing the first small-scale, thin-section turntable bearings available for such demanding applications as robotics, radar antennae, and factory positioning and inspection tables... REALI-SLIM TT® Series. The advantages of this new series vs. conventional turntable bearings include:

Significantly smaller size for greater design versatility and reduced weight;

Greater accuracy — extended radial bearing section increases rigidity, and optional preload or clearances to meet application torque or deflection requirements;

Easier to use — fast installation and changeout;

Custom configurations to meet your application's specific needs — many drive options, gearing/timing belt, mounting hole types; and

Designed to withstand harsh operating environments — AISI-440C steel races, steel reinforced seals.

Figure 2-12

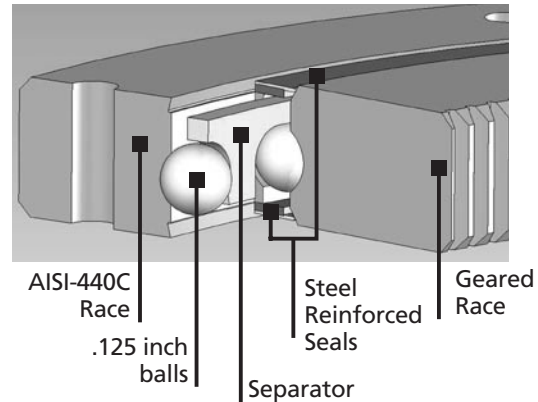

The configurations and specifications you need for more compact, more precise turntable designs

Example of part number breakdown

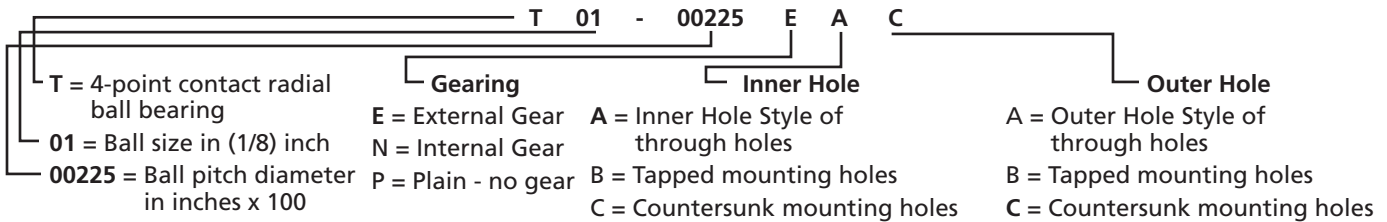

Holes sized for #4-40 screws, tapped, countersunk, or through gears set at full depth involute, 64 DP., 20° pressure angle

Four-Point Contact Bearing (REALI-SLIM TT® Series)

Bearings are most often designed to handle either radial or axial load conditions. The unique feature about the REALI-SLIM TT® Series four-point contact bearing line is that the gothic arch geometry of the inner and outer races enables a single bearing to carry three types of loading (radial, axial and moment) simultaneously. This makes it the bearing of choice for many applications since a single four-point contact bearing can often replace two bearings, providing a simplified design.

REALI-SLIM TT® Series bearings may also be furnished with an internal diametral preload for those applications requiring greater stiffness or zero free play. This is accomplished by using balls that are larger than the space provided in the raceways. The balls and raceways, therefore, have some elastic deformation in the absence of an external load.

Figure 2-13
REALI-SLIM TT® Series

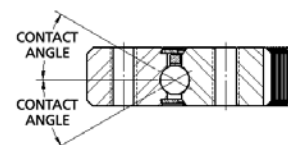

REALI-SLIM TT® SERIES TURNTABLE BEARINGS (continued)**Four-Point Contact Bearing (REALI-SLIM TT® Series)**

Basic Part Number	Radial (lbs.)		Thrust (lbs.)		Moment (in. - lbs.)		Static Torque (in. - lbs.)	Approx. Weight (lbs.)
	Static	Dynamic	Static	Dynamic	Static	Dynamic		
T01-00225	680	520	1,710	790	770	440	3.4	0.35
T01-00275	830	580	2,090	910	1,150	600	4.4	0.43
T01-00325	990	640	2,470	1,010	1,600	780	5.5	0.50
T01-00375	1,140	700	2,850	1,110	2,130	980	6.5	0.59
T01-00425	1,290	750	3,220	1,210	2,740	1,200	7.4	0.67
T01-00450	1,370	780	3,410	1,260	3,070	1,320	7.9	0.70
T01-00475	1,440	810	3,600	1,310	3,420	1,440	8.5	0.74
T01-00500	1,520	830	3,790	1,350	3,790	1,560	9.0	0.78
T01-00525	1,590	860	3,980	1,400	4,180	1,690	9.5	0.82
T01-00575	1,750	910	4,360	1,480	5,020	1,950	10.4	0.89
T01-00625	1,900	950	4,740	1,570	5,930	2,230	11.3	0.98
T01-00675	2,050	1,000	5,120	1,650	6,910	2,530	12.2	1.05

Torque based on seal drag in addition to a light preload

Note: REALI-SLIM TT® Series turntable bearings are custom designed to meet your application's needs.
Contact KAYDON for lead time.

Non-geared Bearings

Part Number with Through Holes	Bore	O.D.	Inner Land	Outer Land	Inner Bolt Circle	Number of holes	Outer Bolt Circle	Number of holes
T01-00225PAA	1.500	3.000	2.148	2.356	1.813	6	2.688	8
T01-00275PAA	2.000	3.500	2.648	2.856	2.313	8	3.188	10
T01-00325PAA	2.500	4.000	3.148	3.356	2.813	9	3.688	12
T01-00375PAA	3.000	4.500	3.648	3.856	3.313	10	4.188	14
T01-00425PAA	3.500	5.000	4.148	4.356	3.813	12	4.688	15
T01-00450PAA	3.750	5.250	4.398	4.606	4.063	12	4.938	16
T01-00475PAA	4.000	5.500	4.648	4.856	4.313	14	5.188	16
T01-00500PAA	4.250	5.750	4.898	5.106	4.563	14	5.438	18
T01-00525PAA	4.500	6.000	5.148	5.356	4.813	15	5.688	18
T01-00575PAA	5.000	6.500	5.648	5.856	5.313	16	6.188	20
T01-00625PAA	5.500	7.000	6.148	6.356	5.813	18	6.688	22
T01-00675PAA	6.000	7.500	6.648	6.856	6.313	20	7.188	22

Externally Geared Bearings

Part Number with Through Holes	Bore	Gear O.D.	Inner Land	Outer Land	Inner Bolt Circle	Number of holes	Outer Bolt Circle	Number of holes	Gear Pitch Dia.	Number of teeth
T01-00225EAA	1.500	3.078	2.148	2.356	1.813	6	2.688	8	3.047	195
T01-00275EAA	2.000	3.578	2.648	2.856	2.313	8	3.188	10	3.547	227
T01-00325EAA	2.500	4.078	3.148	3.356	2.813	9	3.688	12	4.047	259
T01-00375EAA	3.000	4.578	3.648	3.856	3.313	10	4.188	14	4.547	291
T01-00425EAA	3.500	5.078	4.148	4.356	3.813	12	4.688	15	5.047	323
T01-00450EAA	3.750	5.328	4.398	4.606	4.063	12	4.938	16	5.297	339
T01-00475EAA	4.000	5.578	4.648	4.856	4.313	14	5.188	16	5.547	355
T01-00500EAA	4.250	5.828	4.898	5.106	4.563	14	5.438	18	5.797	371
T01-00525EAA	4.500	6.078	5.148	5.356	4.813	15	5.688	18	6.047	387
T01-00575EAA	5.000	6.578	5.648	5.856	5.313	16	6.188	20	6.547	419
T01-00625EAA	5.500	7.078	6.148	6.356	5.813	18	6.688	22	7.047	451
T01-00675EAA	6.000	7.578	6.648	6.856	6.313	20	7.188	22	7.547	483

REALI-SLIM TT® SERIES TURNTABLE BEARINGS (continued)

Internally Geared Bearings

Part Number with Through Holes	Gear I.D.	O.D.	Inner Land	Outer Land	Inner Bolt Circle	Number of holes	Outer Bolt Circle	Number of holes	Gear Pitch Dia.	Number of teeth
T01-00225NAA	1.422	3.000	2.148	2.356	1.813	6	2.688	8	1.453	93
T01-00275NAA	1.922	3.500	2.648	2.856	2.313	8	3.188	10	1.953	125
T01-00325NAA	2.422	4.000	3.148	3.356	2.813	9	3.688	12	2.453	157
T01-00375NAA	2.922	4.500	3.648	3.856	3.313	10	4.188	14	2.953	189
T01-00425NAA	3.422	5.000	4.148	4.356	3.813	12	4.688	15	3.453	221
T01-00450NAA	3.672	5.250	4.398	4.606	4.063	12	4.938	16	3.703	237
T01-00475NAA	3.922	5.500	4.648	4.856	4.313	14	5.188	16	3.953	253
T01-00500NAA	4.172	5.750	4.898	5.106	4.563	14	5.438	18	4.203	269
T01-00525NAA	4.422	6.000	5.148	5.356	4.813	15	5.688	18	4.453	285
T01-00575NAA	4.922	6.500	5.648	5.856	5.313	16	6.188	20	4.953	317
T01-00625NAA	5.422	7.000	6.148	6.356	5.813	18	6.688	22	5.453	349
T01-00675NAA	5.922	7.500	6.648	6.856	6.313	20	7.188	22	5.953	381

The design features and options you asked for

Custom REALI-SLIM TT® Series thin-section bearings are the proven, single four-point contact ball radial design, consisting of a single row of balls with a unique gothic arch raceway and brass separators for low frictional torque. Radial, axial and moment load-capable, the bearings are prelubricated and ready for use; simply position the bearings on the mounting face and tighten the mounting screws! Bearing versions available with optional internal or external spur gear for ease of drive setup, or non-geared designs.

Geared options are 64 diametral pitch with 20° pressure

angle, up to AGMA Class 10, and provide low-backlash service. Built-in seals are a low-torque design, and made of rugged, reliable, steel-reinforced nitrile rubber.

Mounting holes are sized for #4-40 UNC fasteners with optional styles — .136 through holes and countersunk holes, and tapped through. Non-geared races have mounting piloting diameters controlled to .0008 inches.

The bearings are cleaned and packaged in an ISO Class 7 minimum clean room; ISO Class 5 minimum clean room standards are also available.



No gear with through holes

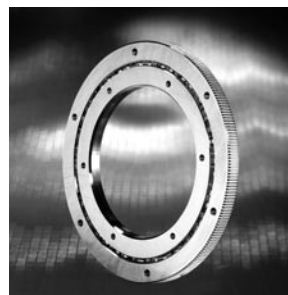

External gear with tapped holes

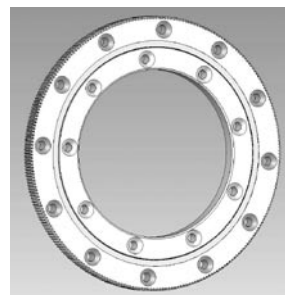

Externally geared bearing with countersunk holes

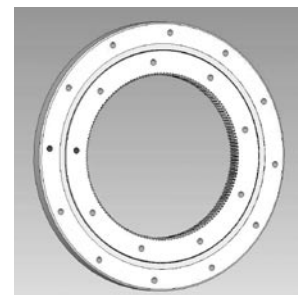

Internal gear with tapped holes

Section 3 — Applications Engineering

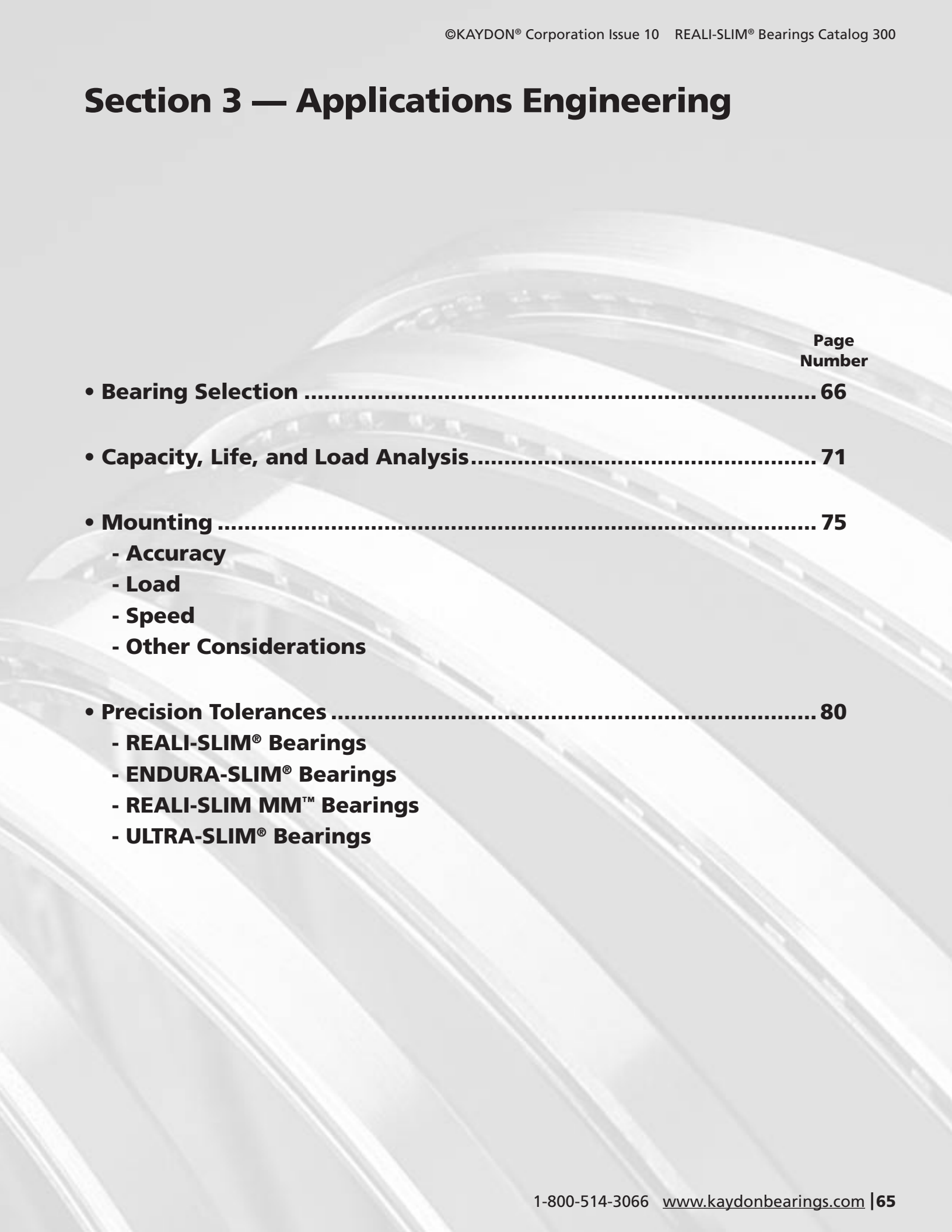

	Page Number
• Bearing Selection	66
• Capacity, Life, and Load Analysis	71
• Mounting	75
- Accuracy	
- Load	
- Speed	
- Other Considerations	
• Precision Tolerances	80
- REALI-SLIM® Bearings	
- ENDURA-SLIM® Bearings	
- REALI-SLIM MM™ Bearings	
- ULTRA-SLIM® Bearings	

Bearing Selection

Type C—Radial Contact

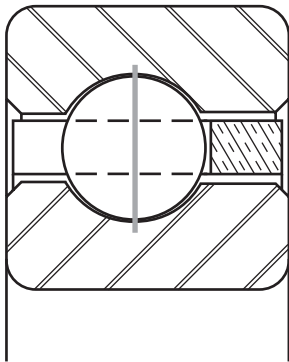

The Type C Radial Contact ball bearing is a single-row radial ball bearing with extra deep ball grooves in both rings (groove depth = 25% of ball diameter). Normally this bearing is assembled by eccentric displacement of the inner race within the outer race which permits insertion of about half of a full complement of balls. After insertion of the balls, the races are positioned concentrically and the balls are spaced about the entire circumference for assembly of the separator. This method of assembly is commonly termed "Conrad Assembly."

An alternate method of assembly is to insert balls through a "filling slot" made by notching the raceway shoulder of one or both races. This method permits assembly with up to a full complement of balls for additional load capacity, however, there are limitations on the operating conditions and these are discussed under Separator Types.

Type C bearings perform best with a small amount of clearance between the balls and races (diametral clearance). Standard bearings are supplied with clearances for:

Interference fitting between bearing races and mounting members;

Differential thermal expansion or contraction of steel races;

Misalignment between shaft and housing and other factors may require the clearance to be adjusted accordingly.

The Type C radial contact bearing is designed to have ball to race contact in the plane of the ball centers

when pure radial load is applied and thrust forces are absent. Necessary diametral clearance may be increased or decreased to meet operating conditions.

While designed primarily for radial load application, the Type C bearing, without a filling slot, will accept some axial (thrust) load in either direction. Its ability to resist axial load, however, is dependent upon the amount of clearance in the bearing after installation. It is this clearance which allows the balls, under axial load, to contact the races at an angle, thereby offering resistance to such load. In the case of the bearing with a filling slot, the notches interrupt the ball contact paths under axial load, minimizing the dynamic thrust capability. Where axial load is present, therefore, rotation of the filling slot bearing must be restricted.

By increasing the diametral clearance beyond the standard amount, the Type C bearing can have a greater angle of contact under axial load, and thus greater thrust capacity. In this case, it is proper to adjust the bearing against another bearing of similar construction to reduce axial movement under reversing thrust forces. Used in this manner, the bearing is essentially an angular contact rather than a radial contact bearing.

Type A—Angular Contact

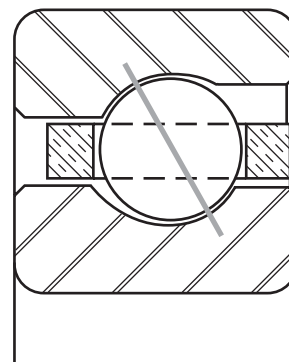

Type A Angular Contact ball bearings differ from Type C bearings in that Type A bearings have sufficient diametral clearance to produce a substantial angle of contact for resistance to axial load. This contact angle is 30° in the standard bearing. As in the Type C bearing, extra deep ball grooves are used (25% of ball diameter).

BEARING SELECTION (continued)

The distinguishing feature of the Type A bearing lies in the method of assembly. One ring, usually the outer, is counter-bored to reduce one shoulder of the raceway to the extent that with the assistance of a temperature differential between the two rings, the outer ring can be installed over the inner race, ball, and separator assembly. This provides a non-separable bearing capable of carrying greater radial loads while resisting a substantial axial force in one direction. With an axial force applied, the faces of the inner and outer rings are approximately flush to minimize preload adjustments.

This assembly method permits the use of a greater complement of balls than is possible in the Type C bearing without filling slots, and together with the sizable contact angle, gives the Type A bearing its greater thrust capacity.

Because of its uni-directional thrust capability, this bearing should be mounted opposed to another bearing such that an axial force is present to establish and maintain the contact angle and to minimize axial movement under reversing thrust loads.

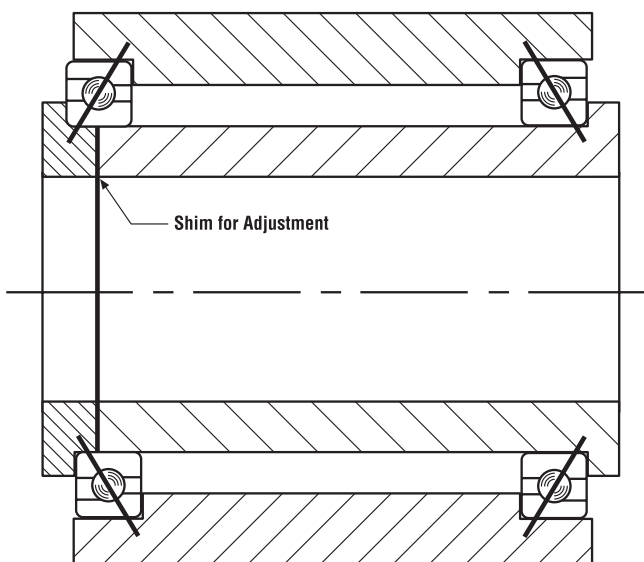
Back-to-back Mounting**Figure 3-1**

Typical mountings of Type A bearings are shown in Figures 3-1 and 3-2. In Figure 3-1, the bearings are mounted with the lines of contact converging outside

of the bearings. This is commonly called a “back-to-back” mounting. In this figure, the bearings are adjustable through the inner races by use of shims under the inner race clamping ring. Sufficient shim thickness is provided initially to allow axial movement of the shaft relative to the housing. The total axial movement can then be measured and the shim thickness reduced by the amount of movement plus any additional amount desired for preload. When two bearings are opposed to each other to the extent that all internal clearance is removed and elastic deformation occurs between the balls and raceways, the bearings are said to be “preloaded.”

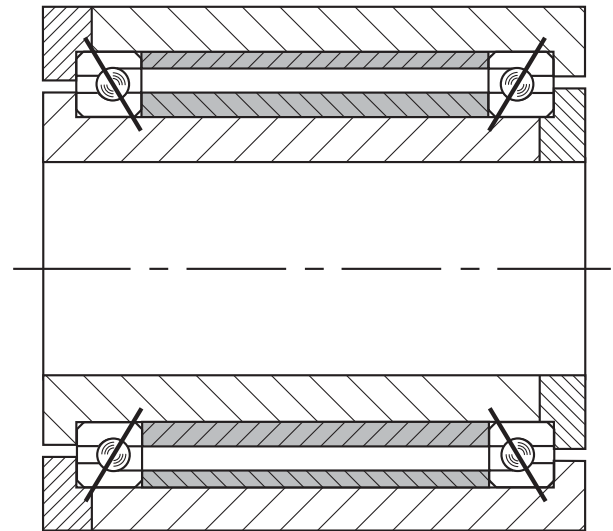
Face-to-face Mounting**Figure 3-2**

In Figure 3-2, the bearings are mounted “face-to-face” with the contact lines converging inward. Spacers are used between both the inner and outer races and adjustment is possible by varying the length of one spacer relative to the other. Normally, however, the spacers are equal in length and the bearings are furnished as a matched pair with a predetermined internal fit. If the outer race spacer were removed from this assembly, the bearings could be adjusted by use of shims under the outer race clamping ring.

BEARING SELECTION (continued)

Duplexed Bearings

Type A bearings are furnished as matched sets — available direct from the factory — when they are to be mounted adjacent or with equal length inner and outer race spacers. When required, KAYDON can supply assemblies with matched ground spacers. The arrangements shown in Figures 3-3, 3-4, and 3-5 are known as duplexed bearings — back-to-back, face-to-face, and tandem, respectively. Sets of three, four or more bearings can also be matched where conditions require additional capacity and there is insufficient space radially for larger bearings.

The bearings in these sets are matched within close limits for size of bore and outside diameter. Each set is marked with a “V” across the bores and outside diameters at the high point of radial runout and indicate the proper orientation of the races at installation (Figure 3-5).

The pairs shown in Figures 3-3 and 3-4 are normally furnished with the race faces ground to provide preload when installed. To accomplish this, a gap is provided between the inner races of the pair in Figure 3-3 and between the outer races of the pair in Figure 3-4. When the bearings are installed and clamped axially, the gap is closed producing a preload on the bearings.

Back-to-back arrangement of Figures 3-1 and 3-3 offers greater rigidity under moment loading and should be used when the space between single bearings is small or when a single pair of adjacent bearings is employed.

Face-to-face arrangement is more tolerant of misalignment between the shaft and housing and should be considered when there are multiple pairs of bearings along an axis. When single bearings are mounted face-to-face, they must be spaced sufficiently to provide resistance to moment load. If

**Figure 3-3
Back-to-back (Type DB)**

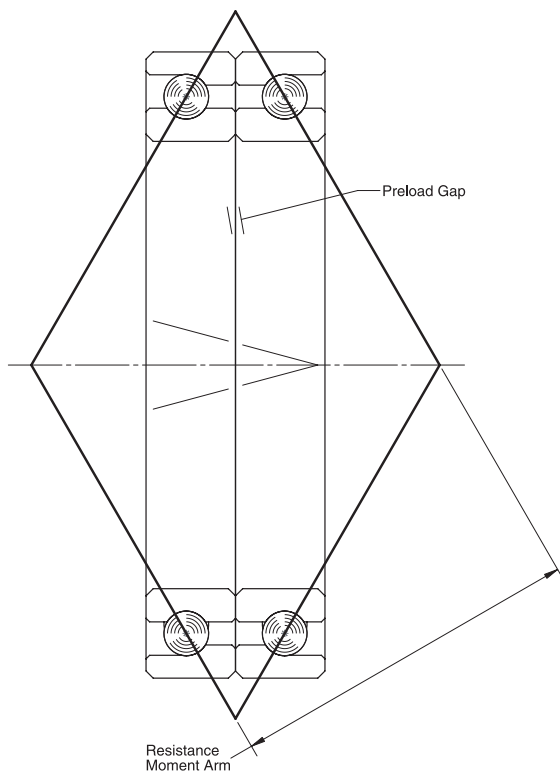

**Figure 3-4
Face-to-face (Type DF)**

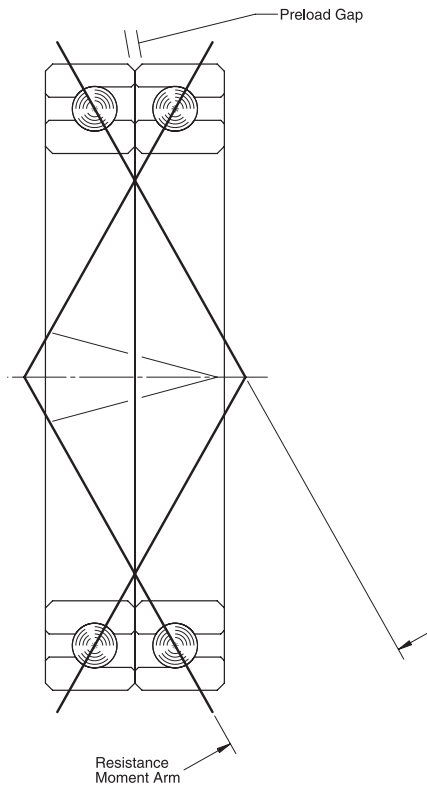

**Figure 3-5
Tandem (Type DT)**

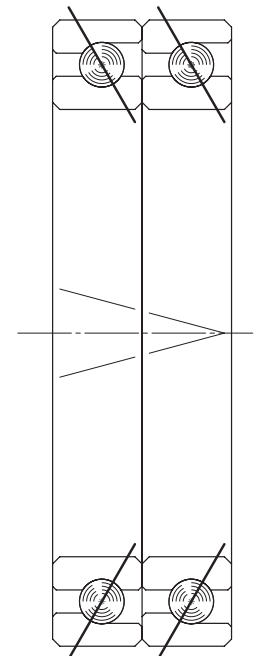

BEARING SELECTION (continued)

required, a face-to-face pair can be mounted in conjunction with another bearing in a “fixed-float” arrangement with the pair in the fixed position. (Also see Section 3, Mounting.)

Tandem bearing sets have single direction thrust capacity and must be mounted opposed to another bearing or set.

When applying catalog load ratings to matched sets, the total radial capacity is considered equal to the single bearing radial rating multiplied by $N^{0.7}$, where N is the number of bearings in the set. The thrust capacity in each direction is considered equal to the single bearing thrust rating multiplied by $N^{0.7}$, where N is the number of bearings resisting thrust in that direction.

Unless specifically requested, the outboard faces of bearing sets are not controlled. If outboard face flushness is required for preload purposes, universally ground bearings should be considered. On universally ground bearings, both inboard and outboard faces are matched under a specified gage load to control preload and allow for mounting orientation flexibility.

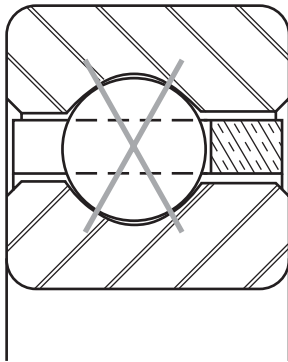
Type X—Four Point Contact

The Type X Four-Point Contact ball bearing is distinguished from Types A and C by the geometry of its ball grooves. In Type C, the centers of the radii both lie in the plane of the ball centers (Figure 3-6). In Type A with the races and balls in angular contact, the centers of the groove radii are offset equal amounts on either side of the plane of the ball centers (Figure 3-7). In the Type X bearing the groove in each race has two radii

whose centers are offset from the plane of the ball centers (Figure 3-8). The latter construction gives the Type X bearing its unique “Gothic Arch” configuration, making possible four contact points between a ball and the raceways.

Type X bearings are assembled by the methods described in Type C bearings, either Conrad or filling slot. With a filling slot, both the dynamic radial and thrust capabilities are impaired by the interruption of the ball contact path, and speed of rotation must be limited.

The depth of groove in the Type X bearing is the same as in Types A and C (25% of ball diameter). The deep groove combined with the four-point contact geometry enables this bearing to resist a combination of radial, thrust, and moment loading. The manner in which the bearing accomplishes this is similar to that of a pair of Type A bearings duplexed back-to-back.

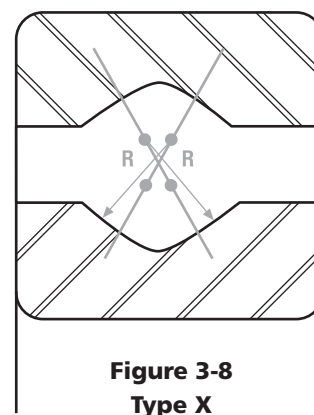
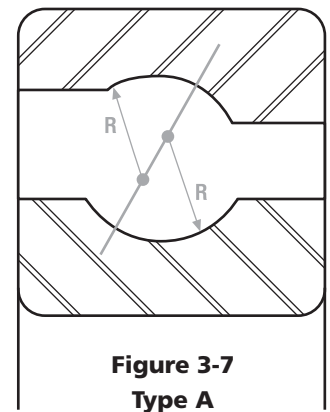
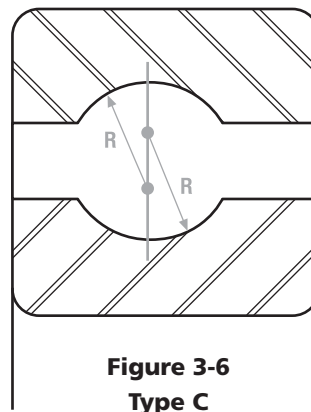

BEARING SELECTION (continued)

Referring to Figure 3-9, an axial force applied to the inner race from right to left is passed from the race to the ball at point B. It is then transmitted through the ball to point D where it passes into the outer race and support structure. The line of action BD forms a nominal 30° angle with the radial centerline of the bearing. Because of the elastic deformation of the ball and the race grooves along the load-transmission line, the ball load is relieved at points A and C, permitting smooth rotation around an axis perpendicular to line BD. With an axial force applied to the inner race from left to right, a similar transmission of load occurs between points C and A.

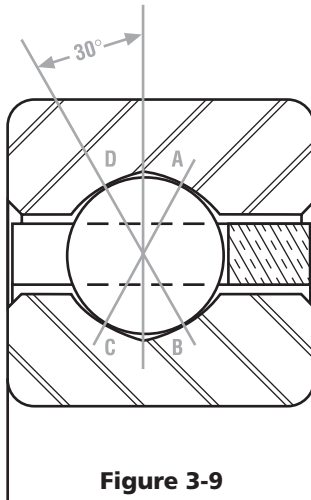
**Figure 3-9****Moment or Overturning Load**

A moment or overturning load is similar to two thrust loads acting in opposite directions at diametrically opposite sides of the bearing. With a moment load, the loading on one side of the bearing will pass from point B to D, relieving points A and C. Directly across the bearing, the load passes from point C to point A, relieving points B and D.

A radial load is resisted equally across the lines of contact CA and BD. Under combined loading the resistance is along both lines of contact with the magnitude of each reaction dependent upon the relationship of the individual loads.

By its ability to resist radial, thrust, and moment loads in any combination, the Type X bearing is often able to replace two bearings—a pair of angular contact ball bearings, a pair of tapered roller bearings, or a

combination of thrust and radial bearings, either ball or roller.

As in the case of the Type C bearing, Type X bearings are normally supplied with diametral clearance. The latter bearing, however, is not dependent upon this clearance for its nominal contact angle and thrust capacity. On the contrary, where thrust or moment loading is considerable, the clearance should be minimized to prevent the angle of contact from becoming excessive. For many applications requiring greater stiffness, Type X bearings are furnished with an internal preload. This is accomplished by using balls larger in diameter than the space provided between the raceways. The balls and raceways in this case have some elastic deformation without the presence of external load.

NOTE: Type X Bearings are designed to be used singularly. Use of two Type X bearings on a common shaft could result in objectionable friction torque.

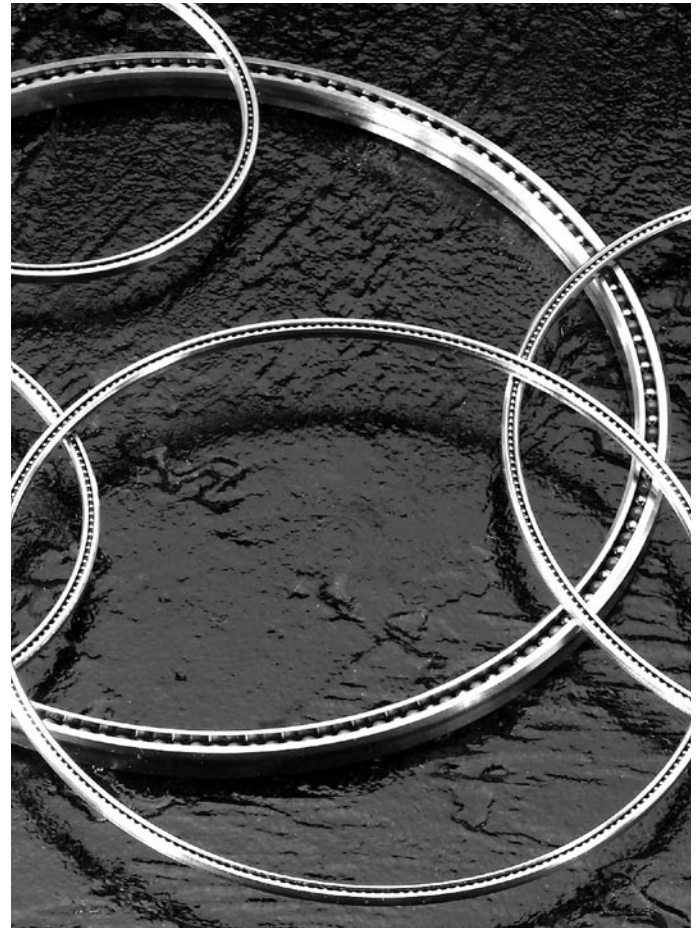

Capacity, Life, and Load Analysis of REALI-SLIM® Ball Bearings

Increased Capacity

Starting with the 2007 edition of this catalog, KAYDON has changed the method used for calculating the dynamic capacity of REALI-SLIM® bearings. The radial and moment capacities of most REALI-SLIM® bearings have been increased.

The increased capacities are based on over five years of actual test data. These changes are also supported by modern bearing fatigue life theory. These values are consistent with both ABMA Std. 9 and ISO-281 calculations, when the proper assumptions are considered. The increased capacities apply to bearings with standard internal clearance. The new values assume that a certain amount of clearance is left in the bearing after installation.

The biggest increase is in the radial capacity of four-point contact (X-Type) bearings. Under the old rating system, four-point contact bearings were given the same capacity as radial (C-Type) bearings. However, in this type of bearing the ball loads are distributed over two lines of contact on each race. This gives lower contact stress and longer life, as demonstrated by KAYDON testing.

Life

The dynamic capacity values shown in this catalog are based on actual data from fatigue life testing. The capacities are based on 1,000,000 revolutions L_{10} fatigue life. This is the industry standard that was established for ease of calculation. It is not advisable to apply loads equal to the dynamic capacities in an actual application. Continuous rotation under these conditions would not normally yield acceptable life.

L_{10} fatigue life is that life which 90% of a representative group of identical bearings can be expected to achieve or exceed before evidence of subsurface material fatigue appears. The life of the remaining 10% is unpredictable. The life which 50% of the bearings may be expected to achieve or exceed is approximately 5 times the L_{10} life. This is known as the L_{50} or median life.

There is no significant difference between the dynamic capacity for inner race rotation versus outer race rotation. This is due to the relatively small ratio of ball diameter to pitch diameter in REALI-SLIM® bearings.

Static load capacities are shown in this catalog. However,

the actual static load a REALI-SLIM® bearing can withstand is dependent upon the amount of support provided by the shaft and housing.

The published capacity numbers allow the user to quickly estimate the bearing L_{10} life for a one-dimensional load case. The life can be estimated using one of the following equations:

$$L_{10} = \left(\frac{C}{P}\right)^3 \cdot 1,000,000 \text{ revolutions}$$

Where: L_{10} = life in revolutions
 C = KAYDON dynamic rating
 P = Applied load (effective)

or

For determining the life in hours at a given speed of rotation the above formula can be changed to read:

$$L_h = \left(\frac{C}{P}\right)^3 \cdot \left(\frac{16,667}{S}\right) \text{ hours}$$

Where: L_h = L_{10} life in hours
 S = Speed in RPM

For multiple load cases or non-standard internal fits, the analysis becomes more complicated. Contact KAYDON Engineering for these cases or consult REALI-DESIGN™ software available on our website www.kaydonbearings.com.

It should be noted that the capacities published in this catalog are best used for comparison purposes. The actual value of a life calculation is only valid for an individual load case and the internal fitup for which the number was derived. Since it is very rare to have a truly radial or axial or moment load, these are not normally used for a life calculation.

Load Analysis

Previous versions of this catalog have discussed applying the loads from a free body diagram to a bearing system and solving for each of four reactions. As there are generally three equations (one for radial, one for axial, one for moment loads) and four unknowns, one of the reactions has been assumed to be zero. Once the remaining reactions are resolved, the life of the bearing can be determined.

CAPACITY, LIFE, AND LOAD ANALYSIS OF REALI-SLIM® BALL BEARINGS (continued)

This method had several drawbacks, including:

- It suggested very low bearing life for systems with predominantly axial loads.
- Internal bearing fitup could not be included in the life calculation.
- All loading was assumed to be distributed around the bearing as though it were a pure radial load... regardless of its origin.

Modern computers and software allow for a more complicated and accurate method of determining life. Illustrated here are the results of this process. The actual loads are applied to the bearing and the resultant load on each and every ball in that bearing is determined. From this data, the static safety factor and dynamic L_{10} life can be determined.

To better understand this, the following should be considered:

Primary Radial Loading

- Larger clearances will have fewer balls carrying the loads, resulting in lower dynamic lives.
- Larger preloads may overload the bearing before the loads are applied.

Primary Axial and Moment Loading

- Larger clearances will permit a higher contact angle than the ball has with the raceway, and thus better support the applied loading.
 - However, the ball-to-raceway contact area may spill over the edge of the race causing other problems.
- Larger preloads may again overload the bearing before the loads are applied.

The method for calculating either a static safety factor or dynamic life requires the use of a computer to determine the individual ball loads throughout the bearing. When these have been calculated, the maximum loaded ball is used to determine a maximum stress level and thus a static safety factor. All of the ball loads are used in a weighted analysis to determine the dynamic L_{10} life.

Since these calculations require a computer, the mathematics required are not shown here. To complete such an analysis, utilize the KAYDON supplied software — REALI-DESIGN™ or REALI-DESIGN MM™ — available at www.kaydonbearings.com.

To better understand these principles, graphical representations of ball distribution around each of three common bearing types are shown in Figures 3-10 through 3-12. Here the ball load distribution and magnitude can be visualized. The higher the peak, the higher the loads.

Figure 3-10

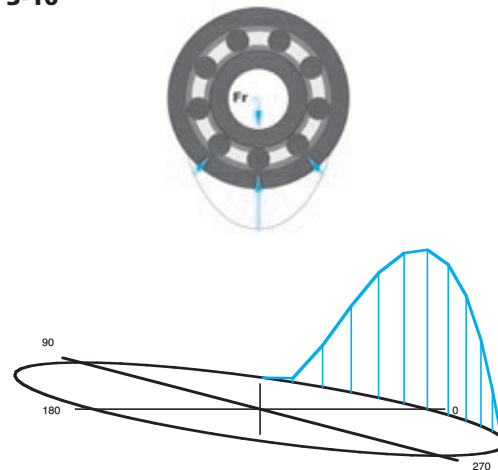

KA040CP0 with 100 lbs. radial load

Clearance in the bearing; few balls carry the load.

This radial bearing has clearance in it. There are only three balls supporting this load, with a very high maximum value for the bottom ball.

Figure 3-11

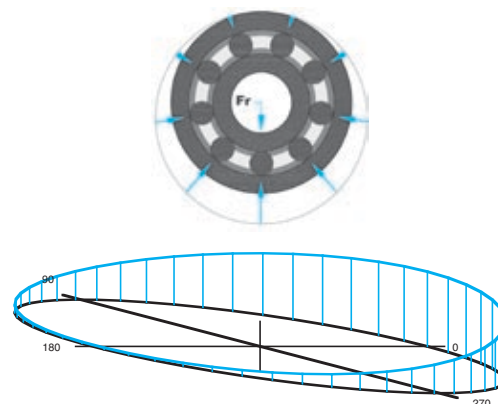

KA040CP0K with 100 lbs. radial load

Light preload in the bearing; all balls carry the load.

This radial bearing has a light preload in it. All the balls have some load on them, and as can be seen, the bottom middle ball has far less load than the example above.

CAPACITY, LIFE, AND LOAD ANALYSIS OF REALI-SLIM® BALL BEARINGS (continued)

Figure 3-12

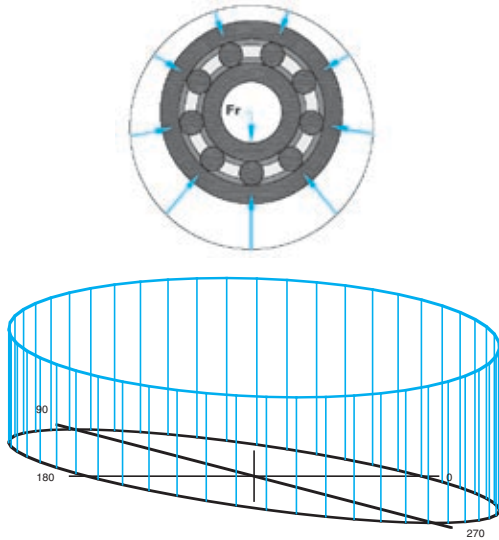

KA040CPOP with 100 lbs. radial load.
Heavy preload.

- Increased Capacity
- Increased Life
- Backed by Theory and Testing

This radial contact bearing has a very heavy preload in it. All the balls have load on them, and the load on the bottom ball is just as high as the bearing with clearance in the first example.

Similar diagrams are shown below for other instances.

Figure 3-13

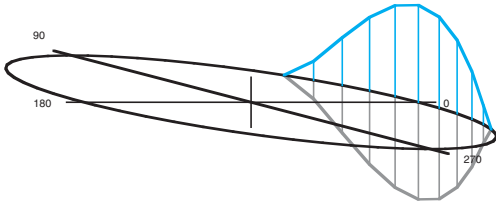

KA040XP0 with 100 lbs. Radial Load
Clearance in bearing; few balls carry the load.

Figure 3-15

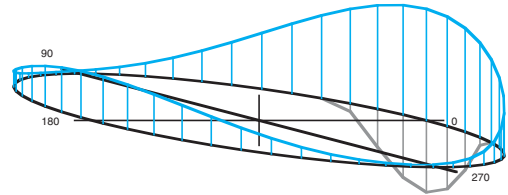

KA040XP0 with 100 lbs. Radial Load, 100 lbs. Axial Load
30 Inch-lbs. Moment Load

Figure 3-14

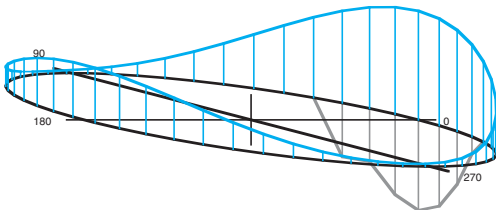

KA040XP0 with 100 lbs. Radial Load, 100 lbs. Axial Load
Lower ball contact, mostly unloaded.

Figure 3-16

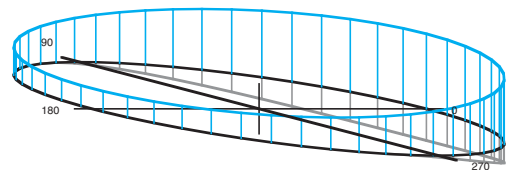

KA040XP0K with 100 lbs. Radial Load, 100 lbs. Axial Load
30 Inch-lbs. Moment Load

CAPACITY, LIFE, AND LOAD ANALYSIS OF REALI-SLIM® BALL BEARINGS (continued)

Section 3—Applications Engineering

Figure 3-17 shows a typical mounting of two angular contact bearings subject to external forces F_r and F_t .

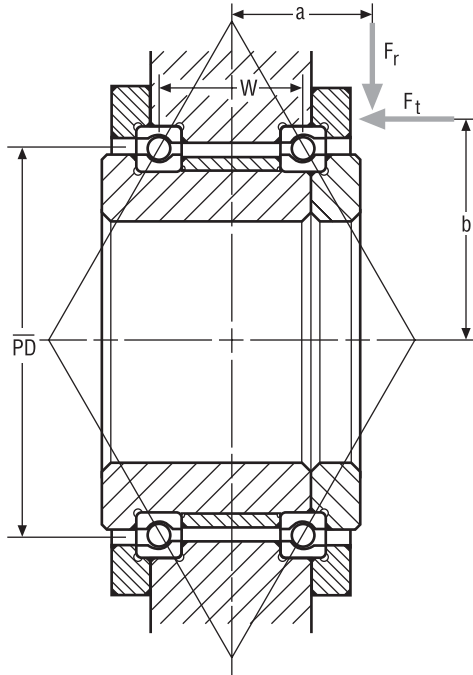

Figure 3-17

Load Diagram for a Back-to-Back Duplex Pair

- Radial Load = F_r
- Axial Load = F_t
- Moment Load = $F_r a - F_t b$

Consult KAYDON REALI-DESIGN™ software for resultant load calculations.

Variable Load Cases

Often a bearing system must operate in several modes such as “idle” and “working.” In this instance, the loads may vary substantially. It is advantageous to calculate the life of the bearing under the total loading spectrum. To do this, the individual life under each load case can be calculated alone, then combined to provide the system life for a particular duty cycle.

To perform this calculation, break the loading up into discrete sections which can have their respective percentage of revolutions represented as part of the total, such as:

Case 1	Case 2	Case 3
Radial ₁	Radial ₂	Radial ₃
Axial ₁	Axial ₂	Axial ₃
Moment ₁	Moment ₂	Moment ₃
% time ₁	% time ₂	% time ₃
L_1	L_2	L_3

Substitute the individual “ L_n ” lives into the equation below with “ t_n ” where $t_n = \% \text{ time}_n$

The total weighted L_{10} life for this system =

$$L_{10w} = \frac{100}{\frac{t_1}{L_1} + \frac{t_2}{L_2} + \frac{t_3}{L_3}}$$



KAYDON software for REALI-SLIM® bearings available at:

www.kaydonbearings.com

Mounting

Orientation

It is suggested that in an application where the bearing axis will be within 45° of vertical, the bearing be positioned with separator pocket openings down or that a shoulder of the shaft or housing be extended as added assurance of retention. Sealed and shielded bearings have this orientation instruction etched on the O.D. by an arrow and the word "up" as shown below.

Figure 3-18

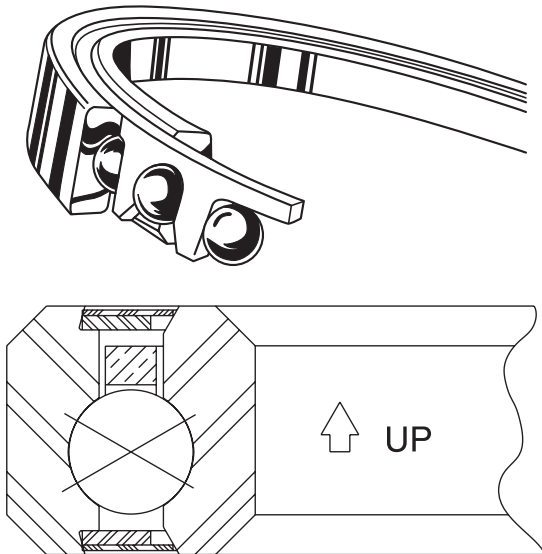

Correct bearing orientation is shown.

Accuracy

Three primary sources of displacement should be considered in a bearing application. These are looseness, deflection and geometric imperfections of the bearing and mating parts. Bearing imperfections consist of radial runout or eccentricity and axial or face runout. Corresponding to these, and of primary concern, are out-of-round and out-of-flat mounting surfaces of the mating parts.

Looseness can occur either between the bearing and the shaft and housing or within the bearing itself. In some applications, looseness cannot be tolerated, especially within the bearing.

Considering the load condition of Figure 3-19, it can be seen that with internal looseness (diametral clearance) in a Type C or Type X bearing, the thrust load will cause axial movement of the shaft relative to the housing.

Because of its unique internal geometry with "built-in" contact angles, a Type X bearing exhibits much less axial movement (axial play) than a Type C bearing of the same dimensions, having the same diametral clearance. So even though the thrust force is within the thrust capability of the Type C bearing, the Type X bearing is the better choice where control of axial movement is important.

Figure 3-19

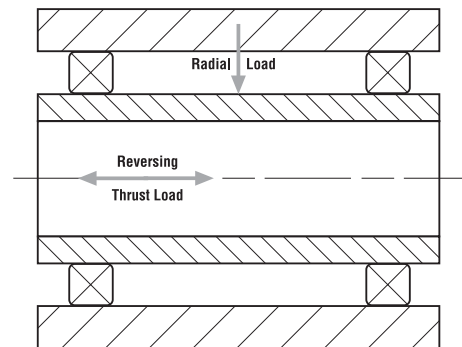

Where axial movement must be completely restricted, the Type X bearing can be preloaded by using balls of greater diameter than the space provided for them between the raceways. This is common practice and provides excellent control of axial play. Where speed is appreciable, however, preload is not acceptable in the Type X bearing due to increased friction and wear. The alternative, then, is to use the mounting of Figure 3-20 employing two Type A bearings. Their geometry is more tolerant of preload, and they offer the advantage of adjustment after installation, making it possible to remove clearance while minimizing preload.

Figure 3-20

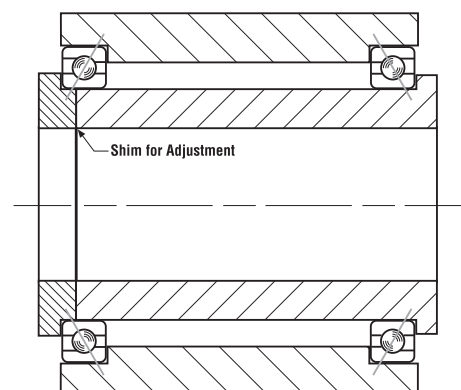

MOUNTING (continued)

Section 3—Applications Engineering

Regarding bearing deflection, questions as to bearing spring rate (ratio of load to deflection) are common. To answer them, the nature and magnitude of the load must be considered. Deflection can occur in three modes: axial, radial, and angular, corresponding to the three types of loads. Therefore, there are three types of spring rates. Moreover, deflection in a ball bearing is non-linear and thus the spring rate is not constant. Typical load vs. deflection curves are shown in Figure 3-21.

Figure 3-21

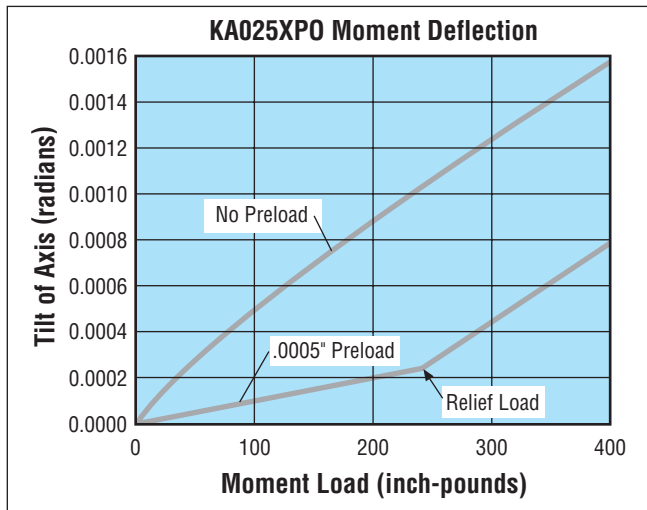

Use KAYDON REALI-DESIGN™ software to generate graphics illustrating the effect of shaft and housing fits for all REALI-SLIM® standard bearings.

Deflection data for the three bearing types is shown on pages 104 through 109.

Deflection (the amount of movement associated with compression or stretching of bearing components when placed under load) varies from one type to another within a given series as a function of the contact angle and the number of balls. Conrad assembled bearings (C and X types) will exhibit greater deflection than those assembled by "loading notch" or than a Type A bearing since C and X types have fewer balls. When two bearings are spaced apart to support a moment load, the space between the bearings is most important when considering angular deflection (tilt-of-axis).

Preloading is also a significant factor in reducing deflection, as shown in the load-deflection curve. In Figure 3-21 it can be seen that a deflection is non-linear for the non-preloaded bearing. In addition, the rate of deflection is higher for lower loads than higher loads.

Deflection for the preloaded bearings is linear up to the point of preload relief. For loads that exceed the preload relief, the subsequent deflection follows the same slope as the non-preloaded curve but at a reduced rate.



Thus if preload is used, the deflection due to the work load will be markedly less whether preload is relieved or not.

The Type A bearing is more tolerant of preload than is the Type X bearing. If maximum stiffness is required and speed of rotation is significant, Type A bearings are preferred.

Bearing precision, which influences accuracy, is independent of bearing type. Radial and axial runout, bore and O.D. tolerances, etc., are essentially the same for Types C, A, and X bearings of a given precision class.

KAYDON offers:

- a breadth of products.
- a wide range of options.
- additional information on our bearings through KAYDON Engineering.



KAYDON software for REALI-SLIM® bearings available at:
www.kaydonbearings.com

MOUNTING (continued)**Load**

With a pure radial load such as shown in Figure 3-22, it can be seen that the Type C bearings in Figure 3-24 would be ideal. They are designed for radial load, require no adjustment at installation, and are available in a wide variety of sizes. As shown, one bearing is fixed axially on both races and the other bearing is free to “float” in the housing. This arrangement permits differential expansion to occur between the shaft and housing without imposing axial loading on the bearings.

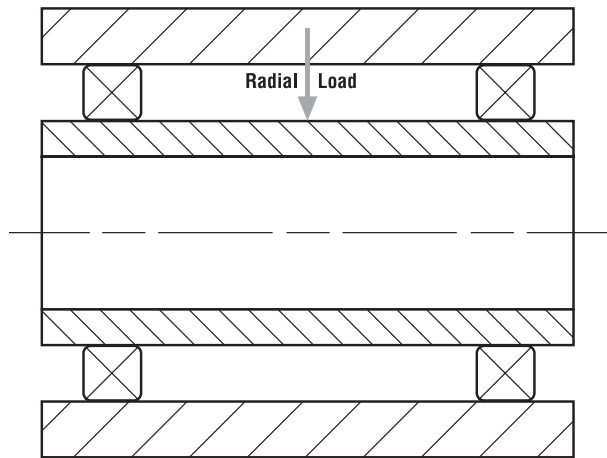
Figure 3-22

With an axial load applied as in Figure 3-19, consideration must be given to the thrust capability of the bearings. Type C bearings will accept some thrust loading, but where this loading is substantial, the Type X or Type A bearing is a better choice. The Type X bearing can be used with a Type C bearing as shown in Figure 3-25. This mounting is the same as that of Figure 3-24 except for the Type X bearing which is used at the “fixed” position to resist thrust in either direction while the Type C bearing “floats” and resists only radial load. With Type A bearings, the mounting could be as shown in Figures 3-27A and 3-27B.

In the third load condition (Figure 3-23), the bearing arrangement in Figure 3-24 will be satisfactory for small thrust loads. Where thrust is significant, the arrangement of Figures 3-20, 3-25, and 3-26 should be considered. In the latter case, one Type X bearing will accommodate the combined loads while effecting savings in space, weight, and cost.

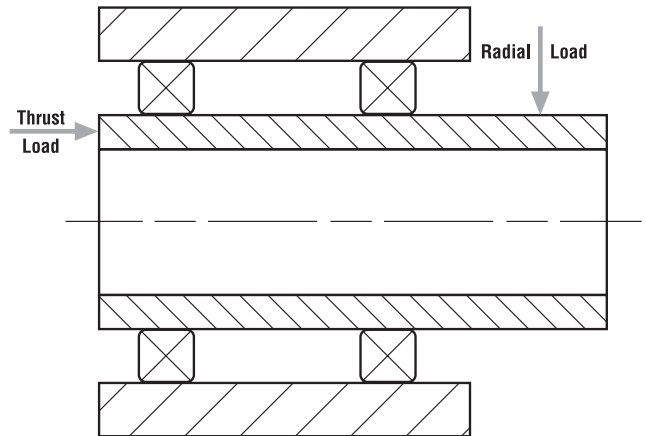
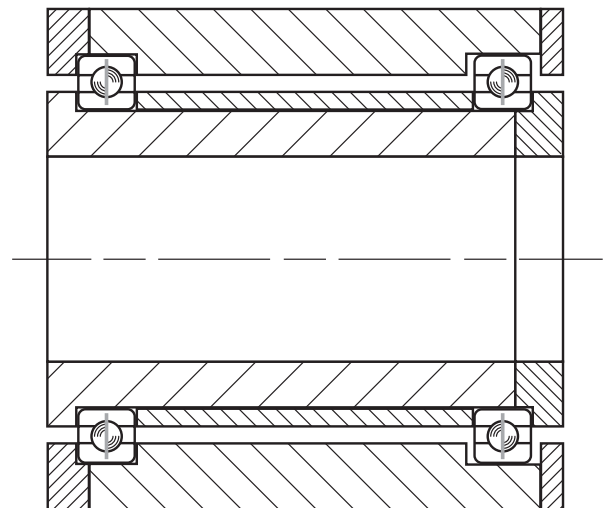
Figure 3-23**Figure 3-24****Speed**

In bearing selection, speed of rotation is equally as important as loading.

Referring to Figure 3-19, arrangements of both Figure 3-20 and Figure 3-25 would satisfy the load conditions, but their suitability for high speed must be considered.

MOUNTING (continued)

Figure 3-25

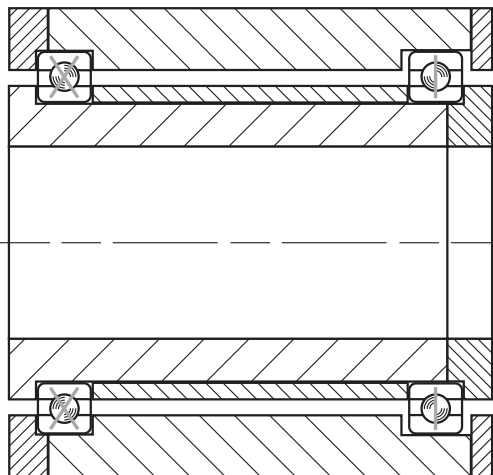

The better arrangement for high speed operation is that using Type A bearings (Figure 3-20), which can be adjusted to provide the optimum internal fit.

There is the possibility of differential expansion creating a problem when two Type A bearings a sizable distance apart are clamped against each other with all internal clearance removed. If this is the case, a “fixed-floating” arrangement can be used as shown in Figures 3-27A and 3-27B with a duplexed pair of Type A bearings at the “fixed” position and a Type C bearing at the “float” position. Another possibility is to spring load the Type A bearings of Figure 3-20.

Figure 3-26

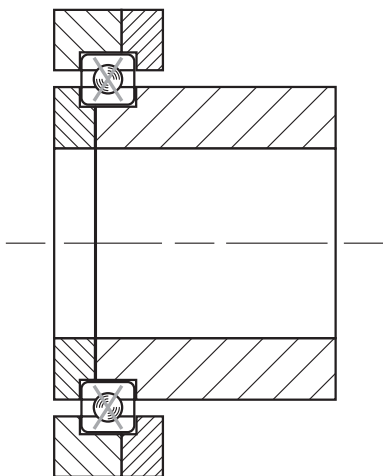

Figure 3-27A - Back to Back

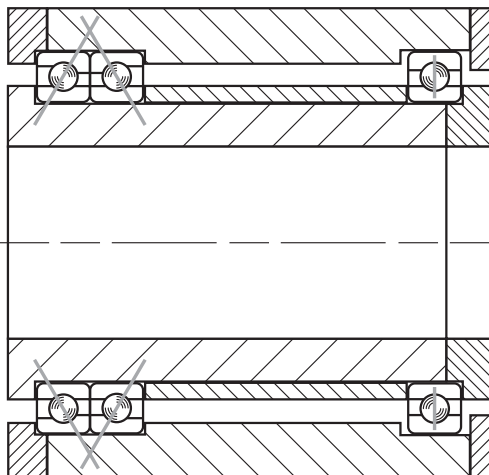
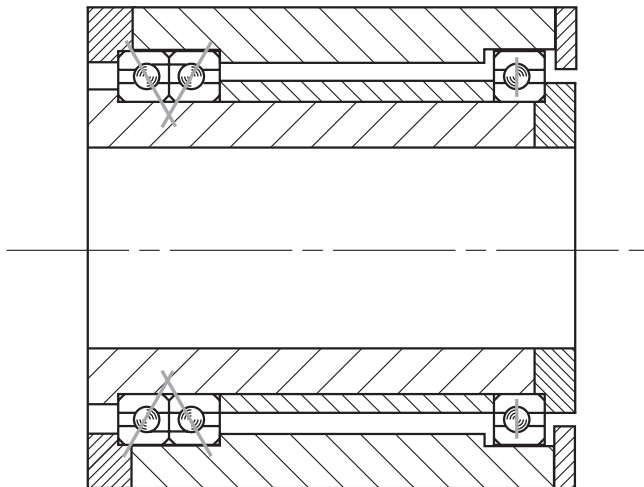
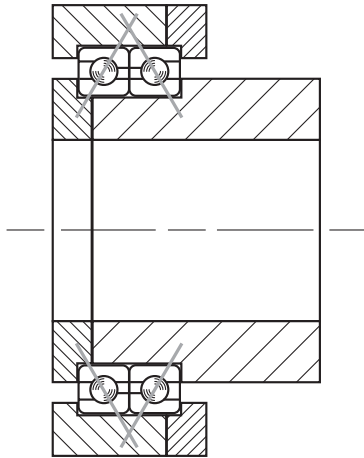

Figure 3-27B - Face to Face



Where space is limited, combined loading exists, and speed is relatively high, a pair of Type A bearings as shown in Figure 3-28 would be given preference over the single Type X bearing of Figure 3-26. In this event preloading must be minimized. This can be accomplished by using a short spacer between the outer races and adjusting the bearings through the inner races.

MOUNTING (continued)**Figure 3-28**

Limiting speeds are given in Section 4.

Other Considerations**Friction Torque**

In applications where minimum driving force is a requirement, consideration should be given to friction torque. For low torque, preload should be avoided if possible. Type X bearings under combined loading can be expected to have more friction than Type A bearings. The separators, ball-to-raceway conformity, lubrication method, shaft and housing fits and temperature are among the factors influencing bearing friction.

Awareness of a low torque requirement enables the bearing engineer to weigh the compatibility of these factors. Additional information on friction torque is in Section 4. For more information, submit Request for Proposal Data form (see page 129 or website) to KAYDON product engineering or consult REALI-DESIGN™ software.

Bearing Mounting

What materials are to be used for the shaft and housing? What range of operating temperatures will be encountered? Will there be a temperature differential between the shaft and housing? The answers to these questions are necessary for proper bearing selection and application. Significant differential expansion will cause marked changes in both the external and internal bearing fits, especially in the case of the thin-section, REALI-SLIM® bearings. These changes affect accuracy, friction, and bearing life.

Ideal Mounting Conditions

- Shaft and housing of material with coefficient of thermal expansion of approximately .000007 inch per inch per degree F

- Shaft and housing diameters round within bearing radial runout tolerances
- Shoulders flat within bearing axial runout tolerances
- Cross sections sufficiently rigid to provide good load distribution within bearing
- Suitable sealing or shielding to protect bearing from contamination

Typical Arrangements**Type C and Type A bearings**

- Used with a second bearing with sufficient separation to resist moment loads
- When the axis of rotation is within 45° of vertical, snapover separators should be positioned with pocket openings down, or the shaft or housing should be extended as added assurance of separator retention.

All Types

- Fixed races located axially by positive means
- Snap rings used only for positioning and light loads
- Shoulders, sleeves, or clamping rings used for heavy loads
- No reliance upon interference fits for resistance to applied axial loads

Temperature

- Means provided to maintain race temperature between -65°F and +250°F with no appreciable differential across the bearing

Lubrication

- Standard bearings are shipped with preservative oil only.
- Preserved bearings must be flushed and lubricated with oil or grease suitable for speed and temperature conditions. See Section 5.

Speed

- Within limits of chart in Section 4 — Consult REALI-DESIGN™ software.

Load

- Static loads within catalog rating after applying the recommended safety factor
- Check that dynamic L_{10} life is sufficient (see page 71). Consult REALI-DESIGN™ software.

Precision Tolerances and Recommended Fits for REALI-SLIM® Ball Bearings in Normal Applications

Section 3—Applications Engineering

TYPE C – PRECISION CLASS 1 (REF. ABEC 1F)												
Bearing Size (Inch Series)	Bearing Diameters		Radial & Axial Runout		Rotating Shaft or Duplex DF Mounting		Stationary Shaft or Duplex DB Mounting				Bearing Diametral Clearance* Before Installation	
	Bearing Bore Nominal +.0000	Bearing O.D. Nominal +.0000	Inner Race	Outer Race	Shaft Diameter Nominal +.0000	Housing Bore Nominal +.0000	Shaft Diameter Nominal		Housing Bore Nominal			
010	-.0004	-.0005	.0005	.0008	+.0004	+.0005	-.0004	-.0008	-.0005	-.0010	.0010	.0016
015	-.0005	-.0005	.0006	.0008	+.0005	+.0005	-.0005	-.0010	-.0005	-.0010	.0012	.0018
017	-.0006	-.0005	.0008	.0010	+.0006	+.0005	-.0006	-.0012	-.0005	-.0010	.0012	.0024
020	-.0006	-.0005	.0008	.0010	+.0006	+.0005	-.0006	-.0012	-.0005	-.0010	.0012	.0024
025	-.0006	-.0005	.0008	.0010	+.0006	+.0005	-.0006	-.0012	-.0005	-.0010	.0012	.0024
030	-.0006	-.0006	.0008	.0010	+.0006	+.0006	-.0006	-.0012	-.0006	-.0012	.0012	.0024
035	-.0008	-.0006	.0010	.0012	+.0008	+.0006	-.0008	-.0016	-.0006	-.0012	.0016	.0028
040	-.0008	-.0006	.0010	.0012	+.0008	+.0006	-.0008	-.0016	-.0006	-.0012	.0016	.0028
042	-.0008	-.0008	.0010	.0014	+.0008	+.0008	-.0008	-.0016	-.0008	-.0016	.0016	.0028
045	-.0008	-.0008	.0010	.0014	+.0008	+.0008	-.0008	-.0016	-.0008	-.0016	.0016	.0028
047	-.0010	-.0008	.0012	.0014	+.0010	+.0008	-.0010	-.0020	-.0008	-.0016	.0020	.0034
050	-.0010	-.0008	.0012	.0014	+.0010	+.0008	-.0010	-.0020	-.0008	-.0016	.0020	.0034
055	-.0010	-.0010	.0012	.0016	+.0010	+.0010	-.0010	-.0020	-.0010	-.0020	.0020	.0034
060	-.0010	-.0010	.0012	.0016	+.0010	+.0010	-.0010	-.0020	-.0010	-.0020	.0020	.0034
065	-.0010	-.0010	.0012	.0016	+.0010	+.0010	-.0010	-.0020	-.0010	-.0020	.0020	.0034
070	-.0010	-.0012	.0012	.0016	+.0010	+.0012	-.0010	-.0020	-.0012	-.0024	.0024	.0042
075	-.0012	-.0012	.0016	.0018	+.0012	+.0012	-.0012	-.0024	-.0012	-.0024	.0024	.0042
080	-.0012	-.0012	.0016	.0018	+.0012	+.0012	-.0012	-.0024	-.0012	-.0024	.0024	.0042
090	-.0012	-.0012	.0016	.0018	+.0012	+.0012	-.0012	-.0024	-.0012	-.0024	.0024	.0042
100	-.0014	-.0014	.0018	.0020	+.0014	+.0014	-.0014	-.0028	-.0014	-.0028	.0028	.0048
110	-.0014	-.0014	.0018	.0020	+.0014	+.0014	-.0014	-.0028	-.0014	-.0028	.0028	.0048
120	-.0014	-.0014	.0018	.0020	+.0014	+.0014	-.0014	-.0028	-.0014	-.0028	.0028	.0048
140	-.0016	-.0016	.0018	.0020	+.0016	+.0016	-.0016	-.0032	-.0016	-.0032	.0032	.0052
160	-.0018	-.0018	.0018	.0020	+.0018	+.0018	-.0018	-.0036	-.0018	-.0036	.0036	.0056
180	-.0018	-.0018	.0020	.0020	+.0018	+.0018	-.0018	-.0036	-.0018	-.0036	.0036	.0056
200	-.0020	-.0020	.0020	.0020	+.0020	+.0020	-.0020	-.0040	-.0020	-.0040	.0040	.0060
210	-.0020	-.0020	.0020	.0020	+.0020	+.0020	-.0020	-.0040	-.0020	-.0040	.0040	.0060
220	-.0020	-.0020	.0020	.0020	+.0020	+.0020	-.0020	-.0040	-.0020	-.0040	.0040	.0060
250	-.0030	-.0030	.0020	.0020	+.0030	+.0030	-.0030	-.0060	-.0030	-.0060	.0060	.0080
300	-.0030	-.0030	.0020	.0020	+.0030	+.0030	-.0030	-.0060	-.0030	-.0060	.0060	.0080
350	-.0040	-.0040	.0020	.0020	+.0040	+.0040	-.0040	-.0080	-.0040	-.0080	.0080	.0100
400	-.0040	-.0040	.0020	.0020	+.0040	+.0040	-.0040	-.0080	-.0040	-.0080	.0080	.0100

* Diametral clearance after installation theoretically can range rather widely if all contributing bearing, housing, and shaft tolerances are at either of their extremes.

Race Width Tolerance:
Up thru 12" Bearing Bore +.000 -.005
Over 12" Bearing Bore +.000 -.010

Listed shaft and housing diameters are for steel supports with standard bearing diametral clearance. Recommended shaft and housing diameters can change greatly based on orientation, temperature, speed, non-standard diametral clearances, and desired performance characteristics. Contact KAYDON for design assistance when required.

All dimensions in inches.

PRECISION TOLERANCES AND RECOMMENDED FITS FOR REALI-SLIM® BEARINGS

TYPE X AND A – PRECISION CLASS 1 (REF. ABEC 1F)												
Bearing Size (Inch Series)	Bearing Diameters		Radial & Axial Runout		Rotating Shaft or Duplex DF Mounting		Stationary Shaft or Duplex DB Mounting				Bearing Diametral Clearance* (Type "X" only)	
	Bearing Bore Nominal +.0000	Bearing O.D. Nominal +.0000	Inner Race	Outer Race	Shaft Diameter Nominal +.0000	Housing Bore Nominal +.0000	Shaft Diameter Nominal		Housing Bore Nominal		Before Installation	
010	-.0004	-.0005	.0003	.0004	+.0004	+.0005	-.0004	-.0008	-.0005	-.0010	.0010	.0015
015	-.0005	-.0005	.0004	.0004	+.0005	+.0005	-.0005	-.0010	-.0005	-.0010	.0012	.0017
017	-.0006	-.0005	.0005	.0005	+.0006	+.0005	-.0006	-.0012	-.0005	-.0010	.0012	.0022
020	-.0006	-.0005	.0005	.0005	+.0006	+.0005	-.0006	-.0012	-.0005	-.0010	.0012	.0022
025	-.0006	-.0005	.0005	.0005	+.0006	+.0005	-.0006	-.0012	-.0005	-.0010	.0012	.0022
030	-.0006	-.0006	.0006	.0006	+.0006	+.0006	-.0006	-.0012	-.0006	-.0012	.0012	.0022
035	-.0008	-.0006	.0006	.0006	+.0008	+.0006	-.0008	-.0016	-.0006	-.0012	.0016	.0026
040	-.0008	-.0006	.0006	.0006	+.0008	+.0006	-.0008	-.0016	-.0006	-.0012	.0016	.0026
042	-.0008	-.0008	.0008	.0008	+.0008	+.0008	-.0008	-.0016	-.0008	-.0016	.0016	.0026
045	-.0008	-.0008	.0008	.0008	+.0008	+.0008	-.0008	-.0016	-.0008	-.0016	.0016	.0026
047	-.0010	-.0008	.0008	.0008	+.0010	+.0008	-.0010	-.0020	-.0008	-.0016	.0020	.0030
050	-.0010	-.0008	.0008	.0008	+.0010	+.0008	-.0010	-.0020	-.0008	-.0016	.0020	.0030
055	-.0010	-.0010	.0010	.0010	+.0010	+.0010	-.0010	-.0020	-.0010	-.0020	.0020	.0030
060	-.0010	-.0010	.0010	.0010	+.0010	+.0010	-.0010	-.0020	-.0010	-.0020	.0020	.0030
065	-.0010	-.0010	.0010	.0010	+.0010	+.0010	-.0010	-.0020	-.0010	-.0020	.0020	.0030
070	-.0010	-.0012	.0010	.0010	+.0010	+.0012	-.0010	-.0020	-.0012	-.0024	.0024	.0034
075	-.0012	-.0012	.0012	.0012	+.0012	+.0012	-.0012	-.0024	-.0012	-.0024	.0024	.0034
080	-.0012	-.0012	.0012	.0012	+.0012	+.0012	-.0012	-.0024	-.0012	-.0024	.0024	.0034
090	-.0012	-.0012	.0012	.0012	+.0012	+.0012	-.0012	-.0024	-.0012	-.0024	.0024	.0034
100	-.0014	-.0014	.0014	.0014	+.0014	+.0014	-.0014	-.0028	-.0014	-.0028	.0028	.0038
110	-.0014	-.0014	.0014	.0014	+.0014	+.0014	-.0014	-.0028	-.0014	-.0028	.0028	.0038
120	-.0014	-.0014	.0014	.0014	+.0014	+.0014	-.0014	-.0028	-.0014	-.0028	.0028	.0038
140	-.0014	-.0014	.0014	.0014	+.0014	+.0014	-.0014	-.0028	-.0014	-.0028	.0028	.0038
160	-.0016	-.0016	.0016	.0016	+.0016	+.0016	-.0016	-.0032	-.0016	-.0032	.0032	.0042
180	-.0016	-.0016	.0016	.0016	+.0016	+.0016	-.0016	-.0032	-.0016	-.0032	.0032	.0042
200	-.0018	-.0018	.0018	.0018	+.0018	+.0018	-.0018	-.0036	-.0018	-.0036	.0036	.0046
210	-.0018	-.0018	.0018	.0018	+.0018	+.0018	-.0018	-.0036	-.0018	-.0036	.0036	.0046
220	-.0018	-.0018	.0018	.0018	+.0018	+.0018	-.0018	-.0036	-.0018	-.0036	.0036	.0046
250	-.0018	-.0018	.0018	.0018	+.0018	+.0018	-.0018	-.0036	-.0018	-.0036	.0036	.0046
300	-.0018	-.0018	.0018	.0018	+.0018	+.0018	-.0018	-.0036	-.0018	-.0036	.0036	.0046
350	-.0020	-.0020	.0020	.0020	+.0020	+.0020	-.0020	-.0040	-.0020	-.0040	.0040	.0050
400	-.0020	-.0020	.0020	.0020	+.0020	+.0020	-.0020	-.0040	-.0020	-.0040	.0040	.0050

* Diametral clearance after installation theoretically can range rather widely if all contributing bearing, housing, and shaft tolerances are at either of their extremes. Diametral clearances shown do not apply to Type A (angular contact) bearings.

Listed shaft and housing diameters are for steel supports with standard bearing diametral clearance. Recommended shaft and housing diameters can change greatly based on orientation, temperature, speed, non-standard diametral clearances, and desired performance characteristics. Contact KAYDON for design assistance when required.

All dimensions in inches.

Total Width Tolerance—Duplexed Type A Bearings:
 Up thru 12" Bearing Bore +.000 -0.10
 Over 12" Bearing Bore +.000 -0.20
 Race Width Tolerance—Single Type C, X, A Bearings:
 Up thru 12" Bearing Bore +.000 -0.05
 Over 12" Bearing Bore +.000 -0.10

PRECISION TOLERANCES AND RECOMMENDED FITS FOR REALI-SLIM® BEARINGS

Section 3—Applications Engineering

TYPE C, X AND A – PRECISION CLASS 3 (REF. ABEC 3F)												
Bearing Size (Inch Series)	Bearing Diameters		Radial & Axial Runout		Rotating Shaft or Duplex DF Mounting		Stationary Shaft or Duplex DB Mounting				Bearing Diametral Clearance* (Type "X" and "C" only) Before Installation	
	Bearing Bore Nominal +.0000	Bearing O.D. Nominal +.0000	Inner Race	Outer Race	Shaft Diameter Nominal +.0000	Housing Bore Nominal +.0000	Shaft Diameter Nominal		Housing Bore Nominal			
010	-.0002	-.0003	.0003	.0004	+.0002	+.0003	-.0002	-.0004	-.0003	-.0006	.0007	.0011
015	-.0003	-.0003	.0004	.0004	+.0003	+.0003	-.0003	-.0006	-.0003	-.0006	.0008	.0012
017	-.0004	-.0004	.0004	.0005	+.0004	+.0004	-.0004	-.0008	-.0004	-.0008	.0008	.0018
020	-.0004	-.0004	.0004	.0005	+.0004	+.0004	-.0004	-.0008	-.0004	-.0008	.0008	.0018
025	-.0004	-.0004	.0004	.0005	+.0004	+.0004	-.0004	-.0008	-.0004	-.0008	.0008	.0018
030	-.0004	-.0004	.0004	.0006	+.0004	+.0004	-.0004	-.0008	-.0004	-.0008	.0008	.0018
035	-.0005	-.0004	.0005	.0006	+.0005	+.0004	-.0005	-.0010	-.0004	-.0008	.0010	.0020
040	-.0005	-.0004	.0005	.0006	+.0005	+.0004	-.0005	-.0010	-.0004	-.0008	.0010	.0020
042	-.0005	-.0005	.0005	.0008	+.0005	+.0005	-.0005	-.0010	-.0005	-.0010	.0010	.0020
045	-.0005	-.0005	.0005	.0008	+.0005	+.0005	-.0005	-.0010	-.0005	-.0010	.0010	.0020
047	-.0006	-.0005	.0006	.0008	+.0006	+.0005	-.0006	-.0012	-.0005	-.0010	.0012	.0022
050	-.0006	-.0005	.0006	.0008	+.0006	+.0005	-.0006	-.0012	-.0005	-.0010	.0012	.0022
055	-.0006	-.0006	.0006	.0009	+.0006	+.0006	-.0006	-.0012	-.0006	-.0012	.0012	.0022
060	-.0006	-.0006	.0006	.0009	+.0006	+.0006	-.0006	-.0012	-.0006	-.0012	.0012	.0022
065	-.0006	-.0006	.0006	.0009	+.0006	+.0006	-.0006	-.0012	-.0006	-.0012	.0012	.0022
070	-.0006	-.0007	.0006	.0010	+.0006	+.0007	-.0006	-.0012	-.0007	-.0014	.0014	.0024
075	-.0007	-.0007	.0008	.0010	+.0007	+.0007	-.0007	-.0014	-.0007	-.0014	.0014	.0024
080	-.0007	-.0007	.0008	.0010	+.0007	+.0007	-.0007	-.0014	-.0007	-.0014	.0014	.0024
090	-.0007	-.0007	.0008	.0010	+.0007	+.0007	-.0007	-.0014	-.0007	-.0014	.0014	.0024
100	-.0008	-.0008	.0010	.0012	+.0008	+.0008	-.0008	-.0016	-.0008	-.0016	.0016	.0026
110	-.0008	-.0008	.0010	.0012	+.0008	+.0008	-.0008	-.0016	-.0008	-.0016	.0016	.0026
120	-.0008	-.0009	.0010	.0014	+.0008	+.0009	-.0008	-.0016	-.0009	-.0018	.0018	.0028
140	-.0008	-.0009	.0012	.0014	+.0008	+.0009	-.0008	-.0016	-.0009	-.0018	.0018	.0028
160	-.0009	-.0010	.0014	.0016	+.0009	+.0010	-.0009	-.0018	-.0010	-.0020	.0020	.0030
180	-.0009	-.0010	.0014	.0016	+.0009	+.0010	-.0009	-.0018	-.0010	-.0020	.0020	.0030
200	-.0010	-.0012	.0016	.0018	+.0010	+.0012	-.0010	-.0020	-.0012	-.0024	.0024	.0034

* Diametral clearance after installation theoretically can range rather widely if all contributing bearing, housing, and shaft tolerances are at either of their extremes. Diametral clearances shown do not apply to Type A (angular contact) bearings.

Total Width Tolerance—Duplexed Type A Bearings:
 Up thru 12" Bearing Bore +.000 –.010
 Over 12" Bearing Bore +.000 –.020

Race Width Tolerance—Single Type C, X, A Bearings:
 Up thru 12" Bearing Bore +.000 –.005
 Over 12" Bearing Bore +.000 –.010

Listed shaft and housing diameters are for steel supports with standard bearing diametral clearance. Recommended shaft and housing diameters can change greatly based on orientation, temperature, speed, non-standard diametral clearances, and desired performance characteristics. Contact KAYDON for design assistance when required.

All dimensions in inches.

PRECISION TOLERANCES AND RECOMMENDED FITS FOR REALI-SLIM® BEARINGS

TYPE C, X AND A – PRECISION CLASS 4 (REF. ABEC 5F)														
Bearing Size (Inch Series)	Bearing Diameters		Radial & Axial Runout				Rotating Shaft or Duplex DF Mounting		Stationary Shaft or Duplex DB Mounting				Bearing Diametral Clearance* (Type "X" and "C" only) Before Installation	
	Bearing Bore Nominal +.0000	Bearing O.D. Nominal +.0000	Inner Race		Outer Race		Shaft Diameter Nominal +.0000	Housing Bore Nominal +.0000	Shaft Diameter Nominal		Housing Bore Nominal			
			Radial	Axial	Radial	Axial								
010	-.0002	-.0002	.0002	.0003	.0002	.0003	+.0002	+.0002	-.0002	-.0004	-.0002	-.0004	.0005	.0009
015	-.0002	-.0002	.0002	.0003	.0002	.0003	+.0002	+.0002	-.0002	-.0004	-.0002	-.0004	.0005	.0009
017	-.0003	-.0003	.0002	.0003	.0003	.0004	+.0003	+.0003	-.0003	-.0006	-.0003	-.0006	.0006	.0012
020	-.0003	-.0003	.0002	.0003	.0003	.0004	+.0003	+.0003	-.0003	-.0006	-.0003	-.0006	.0006	.0012
025	-.0003	-.0003	.0002	.0003	.0003	.0004	+.0003	+.0003	-.0003	-.0006	-.0003	-.0006	.0006	.0012
030	-.0003	-.0003	.0002	.0003	.0004	.0005	+.0003	+.0003	-.0003	-.0006	-.0003	-.0006	.0006	.0012
035	-.0003	-.0003	.0003	.0004	.0004	.0005	+.0003	+.0003	-.0003	-.0006	-.0003	-.0006	.0006	.0012
040	-.0003	-.0003	.0003	.0004	.0004	.0005	+.0003	+.0003	-.0003	-.0006	-.0003	-.0006	.0006	.0012
042	-.0003	-.0004	.0003	.0004	.0004	.0005	+.0003	+.0004	-.0003	-.0006	-.0004	-.0008	.0008	.0014
045	-.0003	-.0004	.0003	.0004	.0004	.0005	+.0003	+.0004	-.0003	-.0006	-.0004	-.0008	.0008	.0014
047	-.0004	-.0004	.0003	.0004	.0004	.0005	+.0004	+.0004	-.0004	-.0008	-.0004	-.0008	.0008	.0014
050	-.0004	-.0004	.0003	.0004	.0004	.0005	+.0004	+.0004	-.0004	-.0008	-.0004	-.0008	.0008	.0014
055	-.0004	-.0005	.0003	.0004	.0005	.0006	+.0004	+.0005	-.0004	-.0008	-.0005	-.0010	.0010	.0016
060	-.0004	-.0005	.0003	.0004	.0005	.0006	+.0004	+.0005	-.0004	-.0008	-.0005	-.0010	.0010	.0016
065	-.0004	-.0005	.0003	.0004	.0005	.0006	+.0004	+.0005	-.0004	-.0008	-.0005	-.0010	.0010	.0016
070	-.0004	-.0005	.0003	.0004	.0005	.0006	+.0004	+.0005	-.0004	-.0008	-.0005	-.0010	.0010	.0016
075	-.0005	-.0005	.0004	.0005	.0005	.0006	+.0005	+.0005	-.0005	-.0010	-.0005	-.0010	.0010	.0016
080	-.0005	-.0005	.0004	.0005	.0005	.0006	+.0005	+.0005	-.0005	-.0010	-.0005	-.0010	.0010	.0016
090	-.0005	-.0005	.0004	.0005	.0005	.0006	+.0005	+.0005	-.0005	-.0010	-.0005	-.0010	.0010	.0016
100	-.0005	-.0005	.0005	.0006	.0006	.0007	+.0005	+.0005	-.0005	-.0010	-.0005	-.0010	.0010	.0016
110	-.0005	-.0005	.0005	.0006	.0006	.0007	+.0005	+.0005	-.0005	-.0010	-.0005	-.0010	.0010	.0016
120	-.0005	-.0006	.0005	.0006	.0007	.0008	+.0005	+.0006	-.0005	-.0010	-.0006	-.0012	.0012	.0018
140	-.0006	-.0006	.0005	.0007	.0007	.0008	+.0006	+.0006	-.0006	-.0012	-.0006	-.0012	.0012	.0018
160	-.0006	-.0007	.0007	.0008	.0008	.0009	+.0006	+.0007	-.0006	-.0012	-.0007	-.0014	.0014	.0020
180	-.0006	-.0007	.0007	.0008	.0008	.0009	+.0006	+.0007	-.0006	-.0012	-.0007	-.0014	.0014	.0020
200	-.0007	-.0008	.0008	.0009	.0009	.0010	+.0007	+.0008	-.0006	-.0014	-.0007	-.0016	.0016	.0022

* Diametral clearance after installation theoretically can range rather widely if all contributing bearing, housing, and shaft tolerances are at either of their extremes. Diametral clearances shown do not apply to Type A (angular contact) bearings.

Listed shaft and housing diameters are for steel supports with standard bearing diametral clearance. Recommended shaft and housing diameters can change greatly based on orientation, temperature, speed, non-standard diametral clearances, and desired performance characteristics. Contact KAYDON for design assistance when required.

All dimensions in inches.

Total Width Tolerance—Duplexed Type A Bearings:

Up thru 12" Bearing Bore +.000 –.010
Over 12" Bearing Bore +.000 –.020

Race Width Tolerance—Single Type C, X, A Bearings:

Up thru 12" Bearing Bore +.000 –.005
Over 12" Bearing Bore +.000 –.010

PRECISION TOLERANCES AND RECOMMENDED FITS FOR REALI-SLIM® BEARINGS

Section 3—Applications Engineering

TYPE C, X AND A – PRECISION CLASS 6 (REF. ABEC 7F)												
Bearing Size (Inch Series)	Bearing Diameters		Radial & Axial Runout		Rotating Shaft or Duplex DF Mounting		Stationary Shaft or Duplex DB Mounting				Bearing Diametral Clearance* (Type "X" and "C" only) Before Installation	
	Bearing Bore Nominal +.0000	Bearing O.D. Nominal +.0000	Inner Race	Outer Race	Shaft Diameter Nominal +.0000	Housing Bore Nominal +.0000	Shaft Diameter Nominal		Housing Bore Nominal			
010	-.00015	-.00020	.00015	.0002	+.00015	+.00020	-.00015	-.00030	-.00020	-.00040	.0004	.0008
015	-.00020	-.00020	.00015	.0002	+.00020	+.00020	-.00020	-.00040	-.00020	-.00040	.0004	.0008
017	-.0002	-.0002	.00015	.0002	+.0002	+.0002	-.0002	-.0004	-.0002	-.0004	.0004	.0010
020	-.0002	-.0002	.00015	.0002	+.0002	+.0002	-.0002	-.0004	-.0002	-.0004	.0004	.0010
025	-.0002	-.0002	.00015	.0002	+.0002	+.0002	-.0002	-.0004	-.0002	-.0004	.0004	.0010
030	-.0002	-.0003	.00015	.0002	+.0002	+.0003	-.0002	-.0004	-.0003	-.0006	.0006	.0012
035	-.00025	-.00030	.0002	.0002	+.00025	+.00030	-.00025	-.00050	-.00030	-.00060	.0006	.0012
040	-.00025	-.00030	.0002	.0002	+.00025	+.00030	-.00025	-.00050	-.00030	-.00060	.0006	.0012
042	-.00025	-.00040	.0002	.0003	+.00025	+.00040	-.00025	-.00050	-.00040	-.00080	.0008	.0014
045	-.00025	-.00040	.0002	.0003	+.00025	+.00040	-.00025	-.00050	-.00040	-.00080	.0008	.0014
047	-.0003	-.0004	.0003	.0003	+.0003	+.0004	-.0003	-.0006	-.0004	-.0008	.0008	.0014
050	-.0003	-.0004	.0003	.0003	+.0003	+.0004	-.0003	-.0006	-.0004	-.0008	.0008	.0014
055	-.0003	-.0004	.0003	.0003	+.0003	+.0004	-.0003	-.0006	-.0004	-.0008	.0008	.0014
060	-.0003	-.0004	.0003	.0003	+.0003	+.0004	-.0003	-.0006	-.0004	-.0008	.0008	.0014
065	-.0003	-.0004	.0003	.0003	+.0003	+.0004	-.0003	-.0006	-.0004	-.0008	.0008	.0014
070	-.0003	-.0004	.0003	.0004	+.0003	+.0004	-.0003	-.0006	-.0004	-.0008	.0008	.0014
075	-.0004	-.0004	.0003	.0004	+.0004	+.0004	-.0004	-.0008	-.0004	-.0008	.0008	.0014
080	-.0004	-.0004	.0003	.0004	+.0004	+.0004	-.0004	-.0008	-.0004	-.0008	.0008	.0014
090	-.0004	-.0004	.0003	.0004	+.0004	+.0004	-.0004	-.0008	-.0004	-.0008	.0008	.0014
100	-.0005	-.0005	.0004	.0004	+.0005	+.0005	-.0005	-.0010	-.0005	-.0010	.0010	.0016
110	-.0005	-.0005	.0004	.0004	+.0005	+.0005	-.0005	-.0010	-.0005	-.0010	.0010	.0016
120	-.0005	-.0005	.0004	.0005	+.0005	+.0005	-.0005	-.0010	-.0005	-.0010	.0010	.0016
140	-.0005	-.0006	.0004	.0005	+.0005	+.0006	-.0005	-.0010	-.0006	-.0012	.0012	.0018

* Diametral clearance after installation theoretically can range rather widely if all contributing bearing, housing, and shaft tolerances are at either of their extremes. Diametral clearances shown do not apply to Type A (angular contact) bearings.

Total Width Tolerance—Duplexed Type A Bearings:

Up thru 12" Bearing Bore +.000 -.010
Over 12" Bearing Bore +.000 -.020

Race Width Tolerance—Single Type C, X, A Bearings:

Up thru 12" Bearing Bore +.000 -.005
Over 12" Bearing Bore +.000 -.010

Listed shaft and housing diameters are for steel supports with standard bearing diametral clearance. Recommended shaft and housing diameters can change greatly based on orientation, temperature, speed, non-standard diametral clearances, and desired performance characteristics. Contact KAYDON for design assistance when required.

All dimensions in inches.

PRECISION TOLERANCES AND RECOMMENDED FITS FOR ENDURA-SLIM® BEARINGS

TYPE C WITH ENDURAKOTE® PLATING – PRECISION CLASS 1												
Bearing Size (Inch Series)	Bearing Diameters		Radial & Axial Runout		Rotating Shaft or Duplex DF Mounting		Stationary Shaft or Duplex DB Mounting				Bearing Diametral Clearance* (Type "X" and "C" only) Before Installation	
	Bearing Bore Nominal +.0000	Bearing O.D. Nominal +.0000	Inner Race	Outer Race	Shaft Diameter Nominal +.0000	Housing Bore Nominal +.0000	Shaft Diameter Nominal		Housing Bore Nominal			
010	-.0006	-.0007	.0005	.0008	.0006	.0007	-.0006	-.0012	-.0007	-.0014	.0010	.0016
015	-.0007	-.0007	.0006	.0008	.0007	.0007	-.0007	-.0014	-.0007	-.0014	.0012	.0018
017	-.0008	-.0007	.0008	.0010	.0008	.0007	-.0008	-.0016	-.0007	-.0014	.0012	.0024
020	-.0008	-.0007	.0008	.0010	.0008	.0007	-.0008	-.0016	-.0007	-.0014	.0012	.0024
025	-.0008	-.0007	.0008	.0010	.0008	.0007	-.0008	-.0016	-.0007	-.0014	.0012	.0024
030	-.0008	-.0008	.0008	.0010	.0008	.0008	-.0008	-.0016	-.0008	-.0016	.0012	.0024
035	-.0010	-.0008	.0010	.0012	.0010	.0008	-.0010	-.0020	-.0008	-.0016	.0016	.0028
040	-.0009	-.0007	.0010	.0012	.0009	.0007	-.0009	-.0018	-.0007	-.0014	.0016	.0028
042	-.0009	-.0009	.0010	.0014	.0009	.0009	-.0009	-.0018	-.0009	-.0018	.0016	.0028
045	-.0009	-.0009	.0010	.0014	.0009	.0009	-.0009	-.0018	-.0009	-.0018	.0016	.0028
047	-.0011	-.0009	.0012	.0014	.0011	.0009	-.0011	-.0022	-.0009	-.0018	.0020	.0034
050	-.0011	-.0009	.0012	.0014	.0011	.0009	-.0011	-.0022	-.0009	-.0018	.0020	.0034
055	-.0011	-.0011	.0012	.0016	.0011	.0011	-.0011	-.0022	-.0011	-.0022	.0020	.0034
060	-.0011	-.0011	.0012	.0016	.0011	.0011	-.0011	-.0022	-.0011	-.0022	.0020	.0034
065	-.0011	-.0011	.0012	.0016	.0011	.0011	-.0011	-.0022	-.0011	-.0022	.0020	.0034
070	-.0011	-.0013	.0012	.0016	.0011	.0013	-.0011	-.0022	-.0013	-.0026	.0024	.0042
075	-.0013	-.0013	.0016	.0018	.0013	.0013	-.0013	-.0026	-.0013	-.0026	.0024	.0042
080	-.0013	-.0013	.0016	.0018	.0013	.0013	-.0013	-.0026	-.0013	-.0026	.0024	.0042
090	-.0013	-.0013	.0016	.0018	.0013	.0013	-.0013	-.0026	-.0013	-.0026	.0024	.0042
100	-.0015	-.0015	.0018	.0020	.0015	.0015	-.0015	-.0030	-.0015	-.0030	.0028	.0048
110	-.0015	-.0015	.0018	.0020	.0015	.0015	-.0015	-.0030	-.0015	-.0030	.0028	.0048
120	-.0015	-.0015	.0018	.0020	.0015	.0015	-.0015	-.0030	-.0015	-.0030	.0028	.0048
140	-.0017	-.0017	.0018	.0020	.0017	.0017	-.0017	-.0034	-.0017	-.0034	.0032	.0052
160	-.0019	-.0019	.0018	.0020	.0019	.0019	-.0019	-.0038	-.0019	-.0038	.0036	.0056
180	-.0019	-.0019	.0020	.0020	.0019	.0019	-.0019	-.0038	-.0019	-.0038	.0036	.0056
200	-.0021	-.0021	.0020	.0020	.0021	.0021	-.0021	-.0042	-.0021	-.0042	.0040	.0060
210	-.0021	-.0021	.0020	.0020	.0021	.0021	-.0021	-.0042	-.0021	-.0042	.0040	.0060
220	-.0021	-.0021	.0020	.0020	.0021	.0021	-.0021	-.0042	-.0021	-.0042	.0040	.0060
250	-.0031	-.0031	.0020	.0020	.0031	.0031	-.0031	-.0062	-.0031	-.0062	.0060	.0080
300	-.0031	-.0031	.0020	.0020	.0031	.0031	-.0031	-.0062	-.0031	-.0062	.0060	.0080
350	-.0041	-.0041	.0020	.0020	.0041	.0041	-.0041	-.0082	-.0041	-.0082	.0080	.0100
400	-.0041	-.0041	.0020	.0020	.0041	.0041	-.0041	-.0082	-.0041	-.0082	.0080	.0100

* Diametral clearance after installation theoretically can range rather widely if all contributing bearing, housing, and shaft tolerances are at either of their extremes. Diametral clearances shown do not apply to Type A (angular contact) bearings.

Listed shaft and housing diameters are for steel supports with standard bearing diametral clearance. Recommended shaft and housing diameters can change greatly based on orientation, temperature, speed, non-standard diametral clearances, and desired performance characteristics. Contact KAYDON for design assistance when required.

All dimensions in inches.

Total Width Tolerance—Duplexed Type A Bearings:

Up thru 12" Bearing Bore +.000 –.010
Over 12" Bearing Bore +.000 –.020

Race Width Tolerance—Single Type C, X, A Bearings:

Up thru 12" Bearing Bore +.000 –.005
Over 12" Bearing Bore +.000 –.010

PRECISION TOLERANCES AND RECOMMENDED FITS FOR ENDURA-SLIM® BEARINGS

TYPE X AND A WITH ENDURAKOTE® PLATING - PRECISION CLASS 1												
Bearing Size (Inch Series)	Bearing Diameters		Radial & Axial Runout		Rotating Shaft or Duplex DF Mounting		Stationary Shaft or Duplex DB Mounting				Bearing Diametral Clearance* (Type "X" and "C" only) Before Installation	
	Bearing Bore Nominal +.0000	Bearing O.D. Nominal +.0000	Inner Race	Outer Race	Shaft Diameter Nominal +.0000	Housing Bore Nominal +.0000	Shaft Diameter Nominal		Housing Bore Nominal			
010	-.0006	-.0007	.0003	.0004	.0006	.0007	-.0006	-.0012	-.0007	-.0014	.0010	.0015
015	-.0007	-.0007	.0004	.0004	.0007	.0007	-.0007	-.0014	-.0007	-.0014	.0012	.0017
017	-.0008	-.0007	.0005	.0005	.0008	.0007	-.0008	-.0016	-.0007	-.0014	.0012	.0022
020	-.0008	-.0007	.0005	.0005	.0008	.0007	-.0008	-.0016	-.0007	-.0014	.0012	.0022
025	-.0008	-.0007	.0005	.0005	.0008	.0007	-.0008	-.0016	-.0007	-.0014	.0012	.0022
030	-.0008	-.0008	.0006	.0006	.0008	.0008	-.0008	-.0016	-.0008	-.0016	.0012	.0022
035	-.0010	-.0008	.0006	.0006	.0010	.0008	-.0010	-.0020	-.0008	-.0016	.0016	.0026
040	-.0009	-.0007	.0006	.0006	.0009	.0007	-.0009	-.0018	-.0007	-.0014	.0016	.0026
042	-.0009	-.0009	.0008	.0008	.0009	.0009	-.0009	-.0018	-.0009	-.0018	.0016	.0026
045	-.0009	-.0009	.0008	.0008	.0009	.0009	-.0009	-.0018	-.0009	-.0018	.0016	.0026
047	-.0011	-.0009	.0008	.0008	.0011	.0009	-.0011	-.0022	-.0009	-.0018	.0020	.0030
050	-.0011	-.0009	.0008	.0008	.0011	.0009	-.0011	-.0022	-.0009	-.0018	.0020	.0030
055	-.0011	-.0011	.0010	.0010	.0011	.0011	-.0011	-.0022	-.0011	-.0022	.0020	.0030
060	-.0011	-.0011	.0010	.0010	.0011	.0011	-.0011	-.0022	-.0011	-.0022	.0020	.0030
065	-.0011	-.0011	.0010	.0010	.0011	.0011	-.0011	-.0022	-.0011	-.0022	.0020	.0030
070	-.0011	-.0013	.0010	.0010	.0011	.0013	-.0011	-.0022	-.0013	-.0026	.0024	.0034
075	-.0013	-.0013	.0012	.0012	.0013	.0013	-.0013	-.0026	-.0013	-.0026	.0024	.0034
080	-.0013	-.0013	.0012	.0012	.0013	.0013	-.0013	-.0026	-.0013	-.0026	.0024	.0034
090	-.0013	-.0013	.0012	.0012	.0013	.0013	-.0013	-.0026	-.0013	-.0026	.0024	.0034
100	-.0015	-.0015	.0014	.0014	.0015	.0015	-.0015	-.0030	-.0015	-.0030	.0028	.0038
110	-.0015	-.0015	.0014	.0014	.0015	.0015	-.0015	-.0030	-.0015	-.0030	.0028	.0038
120	-.0015	-.0015	.0014	.0014	.0015	.0015	-.0015	-.0030	-.0015	-.0030	.0028	.0038
140	-.0015	-.0015	.0014	.0014	.0015	.0015	-.0015	-.0030	-.0015	-.0030	.0028	.0038
160	-.0017	-.0017	.0016	.0016	.0017	.0017	-.0017	-.0034	-.0017	-.0034	.0032	.0042
180	-.0017	-.0017	.0016	.0016	.0017	.0017	-.0017	-.0034	-.0017	-.0034	.0032	.0042
200	-.0019	-.0019	.0018	.0018	.0019	.0019	-.0019	-.0038	-.0019	-.0038	.0036	.0046
210	-.0019	-.0019	.0018	.0018	.0019	.0019	-.0019	-.0038	-.0019	-.0038	.0036	.0046
220	-.0019	-.0019	.0018	.0018	.0019	.0019	-.0019	-.0038	-.0019	-.0038	.0036	.0046
250	-.0019	-.0019	.0018	.0018	.0019	.0019	-.0019	-.0038	-.0019	-.0038	.0036	.0046
300	-.0019	-.0019	.0018	.0018	.0019	.0019	-.0019	-.0038	-.0019	-.0038	.0036	.0046
350	-.0021	-.0021	.0020	.0020	.0021	.0021	-.0021	-.0042	-.0021	-.0042	.0040	.0050
400	-.0021	-.0021	.0020	.0020	.0021	.0021	-.0021	-.0042	-.0021	-.0042	.0040	.0050

* Diametral clearance after installation theoretically can range rather widely if all contributing bearing, housing, and shaft tolerances are at either of their extremes. Diametral clearances shown do not apply to Type A (angular contact) bearings.

Total Width Tolerance—Duplexed Type A Bearings:

Up thru 12" Bearing Bore +.000 –.010
Over 12" Bearing Bore +.000 –.020

Race Width Tolerance—Single Type C, X, A Bearings:

Up thru 12" Bearing Bore +.000 –.005
Over 12" Bearing Bore +.000 –.010

Listed shaft and housing diameters are for steel supports with standard bearing diametral clearance. Recommended shaft and housing diameters can change greatly based on orientation, temperature, speed, non-standard diametral clearances, and desired performance characteristics. Contact KAYDON for design assistance when required.

All dimensions in inches.

PRECISION TOLERANCES AND RECOMMENDED FITS FOR ENDURA-SLIM® BEARINGS

TYPE C, X, AND A WITH ENDURAKOTE® PLATING – PRECISION CLASS 3												
Bearing Size (Inch Series)	Bearing Diameters		Radial & Axial Runout		Rotating Shaft or Duplex DF Mounting		Stationary Shaft or Duplex DB Mounting				Bearing Diametral Clearance* (Type "X" and "C" only) Before Installation	
	Bearing Bore Nominal +.0000	Bearing O.D. Nominal +.0000	Inner Race	Outer Race	Shaft Diameter Nominal +.0000	Housing Bore Nominal +.0000	Shaft Diameter Nominal		Housing Bore Nominal			
010	-.0004	-.0005	.0003	.0004	.0004	.0005	-.0004	-.0008	-.0005	-.0010	.0007	.0011
015	-.0005	-.0005	.0004	.0004	.0005	.0005	-.0005	-.0010	-.0005	-.0010	.0008	.0012
017	-.0006	-.0006	.0004	.0005	.0006	.0006	-.0006	-.0012	-.0006	-.0012	.0008	.0018
020	-.0006	-.0006	.0004	.0005	.0006	.0006	-.0006	-.0012	-.0006	-.0012	.0008	.0018
025	-.0006	-.0006	.0004	.0005	.0006	.0006	-.0006	-.0012	-.0006	-.0012	.0008	.0018
030	-.0006	-.0006	.0004	.0006	.0006	.0006	-.0006	-.0012	-.0006	-.0012	.0008	.0018
035	-.0007	-.0006	.0005	.0006	.0007	.0006	-.0007	-.0014	-.0006	-.0012	.0010	.0020
040	-.0007	-.0006	.0005	.0006	.0007	.0006	-.0007	-.0014	-.0006	-.0012	.0010	.0020
042	-.0007	-.0007	.0005	.0008	.0007	.0007	-.0007	-.0014	-.0007	-.0014	.0010	.0020
045	-.0007	-.0007	.0005	.0008	.0007	.0007	-.0007	-.0014	-.0007	-.0014	.0010	.0020
047	-.0008	-.0007	.0006	.0008	.0008	.0007	-.0008	-.0016	-.0007	-.0014	.0012	.0022
050	-.0008	-.0007	.0006	.0008	.0008	.0007	-.0008	-.0016	-.0007	-.0014	.0012	.0022
055	-.0008	-.0008	.0006	.0009	.0008	.0008	-.0008	-.0016	-.0008	-.0016	.0012	.0022
060	-.0008	-.0008	.0006	.0009	.0008	.0008	-.0008	-.0016	-.0008	-.0016	.0012	.0022
065	-.0008	-.0008	.0006	.0009	.0008	.0008	-.0008	-.0016	-.0008	-.0016	.0012	.0022
070	-.0008	-.0009	.0006	.0010	.0008	.0009	-.0008	-.0016	-.0009	-.0018	.0014	.0024
075	-.0009	-.0009	.0008	.0010	.0009	.0009	-.0009	-.0018	-.0009	-.0018	.0014	.0024
080	-.0009	-.0009	.0008	.0010	.0009	.0009	-.0009	-.0018	-.0009	-.0018	.0014	.0024
090	-.0009	-.0009	.0008	.0010	.0009	.0009	-.0009	-.0018	-.0009	-.0018	.0014	.0024
100	-.0010	-.0010	.0010	.0012	.0010	.0010	-.0010	-.0020	-.0010	-.0020	.0016	.0026
110	-.0010	-.0010	.0010	.0012	.0010	.0010	-.0010	-.0020	-.0010	-.0020	.0016	.0026
120	-.0010	-.0011	.0010	.0014	.0010	.0011	-.0010	-.0020	-.0011	-.0022	.0018	.0028
140	-.0010	-.0011	.0012	.0014	.0010	.0011	-.0010	-.0020	-.0011	-.0022	.0018	.0028
160	-.0011	-.0012	.0014	.0016	.0011	.0012	-.0011	-.0022	-.0012	-.0024	.0020	.0030
180	-.0011	-.0012	.0014	.0016	.0011	.0012	-.0011	-.0022	-.0012	-.0024	.0020	.0030
200	-.0012	-.0014	.0016	.0018	.0012	.0014	-.0012	-.0024	-.0014	-.0028	.0024	.0034

* Diametral clearance after installation theoretically can range rather widely if all contributing bearing, housing, and shaft tolerances are at either of their extremes. Diametral clearances shown do not apply to Type A (angular contact) bearings.

Listed shaft and housing diameters are for steel supports with standard bearing diametral clearance. Recommended shaft and housing diameters can change greatly based on orientation, temperature, speed, non-standard diametral clearances, and desired performance characteristics. Contact KAYDON for design assistance when required.

All dimensions in inches.

Total Width Tolerance—Duplexed Type A Bearings:
 Up thru 12" Bearing Bore +.000 –.010
 Over 12" Bearing Bore +.000 –.020
 Race Width Tolerance—Single Type C, X, A Bearings:
 Up thru 12" Bearing Bore +.000 –.005
 Over 12" Bearing Bore +.000 –.010

PRECISION TOLERANCES AND RECOMMENDED FITS FOR ENDURA-SLIM® BEARINGS

TYPE C, X, AND A WITH ENDURAKOTE® PLATING – PRECISION CLASS 4														
Bearing Size (inch series)	Bearing Diameters		Radial and Axial Runout				Rotating Shaft or Duplex DF Mounting		Stationary Shaft or Duplex DB Mounting				Bearing Diametral Clearance* (Type "X" and "C" Only) Before Installation	
	Bearing Bore Nominal +.0000	Bearing OD Nominal +.0000	Inner Race		Outer Race		Shaft Diameter Nominal -.0000	Housing Bore Nominal -.0000	Shaft Diameter Nominal		Housing Bore Nominal			
			Radial	Axial	Radial	Axial								
010	-.0004	-.0004	.0002	.0003	.0002	.0003	.0004	.0004	-.0004	-.0008	-.0004	-.0008	.0005	.0009
015	-.0004	-.0004	.0002	.0003	.0002	.0003	.0004	.0004	-.0004	-.0008	-.0004	-.0008	.0005	.0009
017	-.0005	-.0005	.0002	.0003	.0003	.0004	.0005	.0005	-.0005	-.0010	-.0005	-.0010	.0006	.0012
020	-.0005	-.0005	.0002	.0003	.0003	.0004	.0005	.0005	-.0005	-.0010	-.0005	-.0010	.0006	.0012
025	-.0005	-.0005	.0002	.0003	.0003	.0004	.0005	.0005	-.0005	-.0010	-.0005	-.0010	.0006	.0012
030	-.0005	-.0005	.0002	.0003	.0004	.0005	.0005	.0005	-.0005	-.0010	-.0005	-.0010	.0006	.0012
035	-.0005	-.0005	.0003	.0004	.0004	.0005	.0005	.0005	-.0005	-.0010	-.0005	-.0010	.0006	.0012
040	-.0005	-.0005	.0003	.0004	.0004	.0005	.0005	.0005	-.0005	-.0010	-.0005	-.0010	.0006	.0012
042	-.0005	-.0006	.0003	.0004	.0004	.0005	.0005	.0006	-.0005	-.0010	-.0006	-.0012	.0008	.0014
045	-.0005	-.0006	.0003	.0004	.0004	.0005	.0005	.0006	-.0005	-.0010	-.0006	-.0012	.0008	.0014
047	-.0006	-.0006	.0003	.0004	.0004	.0005	.0006	.0006	-.0006	-.0012	-.0006	-.0012	.0008	.0014
050	-.0006	-.0006	.0003	.0004	.0004	.0005	.0006	.0006	-.0006	-.0012	-.0006	-.0012	.0008	.0014
055	-.0006	-.0007	.0003	.0004	.0005	.0006	.0006	.0007	-.0006	-.0012	-.0007	-.0014	.0010	.0016
060	-.0006	-.0007	.0003	.0004	.0005	.0006	.0006	.0007	-.0006	-.0012	-.0007	-.0014	.0010	.0016
065	-.0006	-.0007	.0003	.0004	.0005	.0006	.0006	.0007	-.0006	-.0012	-.0007	-.0014	.0010	.0016
070	-.0006	-.0007	.0003	.0004	.0005	.0006	.0006	.0007	-.0006	-.0012	-.0007	-.0014	.0010	.0016
075	-.0007	-.0007	.0004	.0005	.0005	.0006	.0007	.0007	-.0007	-.0014	-.0007	-.0014	.0010	.0016
080	-.0007	-.0007	.0004	.0005	.0005	.0006	.0007	.0007	-.0007	-.0014	-.0007	-.0014	.0010	.0016
090	-.0007	-.0007	.0004	.0005	.0005	.0006	.0007	.0007	-.0007	-.0014	-.0007	-.0014	.0010	.0016
100	-.0007	-.0007	.0005	.0006	.0006	.0007	.0007	.0007	-.0007	-.0014	-.0007	-.0014	.0010	.0016
110	-.0007	-.0007	.0005	.0006	.0006	.0007	.0007	.0007	-.0007	-.0014	-.0007	-.0014	.0010	.0016
120	-.0007	-.0008	.0005	.0006	.0007	.0008	.0007	.0008	-.0007	-.0014	-.0008	-.0016	.0012	.0018
140	-.0008	-.0008	.0005	.0007	.0007	.0008	.0008	.0008	-.0008	-.0016	-.0008	-.0016	.0012	.0018
160	-.0008	-.0009	.0007	.0008	.0008	.0009	.0008	.0009	-.0008	-.0016	-.0009	-.0018	.0014	.0020
180	-.0008	-.0009	.0007	.0008	.0008	.0009	.0008	.0009	-.0008	-.0016	-.0009	-.0018	.0014	.0020
200	-.0009	-.0010	.0008	.0009	.0009	.0010	.0009	.0010	-.0009	-.0018	-.0010	-.0020	.0016	.0022

* Diametral clearance after installation theoretically can range rather widely if all contributing bearing, housing, and shaft tolerances are at either of their extremes. Diametral clearances shown do not apply to Type A (angular contact) bearings.

Total Width Tolerance—Duplexed Type A Bearings:
 Up thru 12" Bearing Bore +.000 -.010
 Over 12" Bearing Bore +.000 -.020
 Race Width Tolerance—Single Type C, X, A Bearings:
 Up thru 12" Bearing Bore +.000 -.005
 Over 12" Bearing Bore +.000 -.010

Listed shaft and housing diameters are for steel supports with standard bearing diametral clearance. Recommended shaft and housing diameters can change greatly based on orientation, temperature, speed, non-standard diametral clearances, and desired performance characteristics. Contact KAYDON for design assistance when required.

All dimensions in inches.

PRECISION TOLERANCES AND RECOMMENDED FITS FOR ENDURA-SLIM® BEARINGS

TYPE C, X, AND A WITH ENDURAKOTE® PLATING – PRECISION CLASS 6												
Bearing Size (Inch Series)	Bearing Diameters		Radial & Axial Runout		Rotating Shaft or Duplex DF Mounting		Stationary Shaft or Duplex DB Mounting				Bearing Diametral Clearance* (Type "X" and "C" only) Before Installation	
	Bearing Bore Nominal +.0000	Bearing O.D. Nominal +.0000	Inner Race	Outer Race	Shaft Diameter Nominal +.0000	Housing Bore Nominal +.0000	Shaft Diameter Nominal		Housing Bore Nominal			
010	-.00035	-.0004	.00015	.0002	.00035	.0004	-.00035	-.0007	-.0004	-.0008	.0004	.0008
015	-.0004	-.0004	.00015	.0002	.0004	.0004	-.0004	-.0008	-.0004	-.0008	.0004	.0008
017	-.0004	-.0004	.00015	.0002	.0004	.0004	-.0004	-.0008	-.0004	-.0008	.0004	.0010
020	-.0004	-.0004	.00015	.0002	.0004	.0004	-.0004	-.0008	-.0004	-.0008	.0004	.0010
025	-.0004	-.0004	.00015	.0002	.0004	.0004	-.0004	-.0008	-.0004	-.0008	.0004	.0010
030	-.0004	-.0005	.00015	.0002	.0004	.0005	-.0004	-.0008	-.0005	-.0010	.0006	.0012
035	-.00045	-.0005	.0002	.0002	.00045	.0005	-.00045	-.0009	-.0005	-.0010	.0006	.0012
040	-.00045	-.0005	.0002	.0002	.00045	.0005	-.00045	-.0009	-.0005	-.0010	.0006	.0012
042	-.00045	-.0006	.0002	.0003	.00045	.0006	-.00045	-.0009	-.0006	-.0012	.0008	.0014
045	-.00045	-.0006	.0002	.0003	.00045	.0006	-.00045	-.0009	-.0006	-.0012	.0008	.0014
047	-.0005	-.0006	.0003	.0003	.0005	.0006	-.0005	-.0010	-.0006	-.0012	.0008	.0014
050	-.0005	-.0006	.0003	.0003	.0005	.0006	-.0005	-.0010	-.0006	-.0012	.0008	.0014
055	-.0005	-.0006	.0003	.0003	.0005	.0006	-.0005	-.0010	-.0006	-.0012	.0008	.0014
060	-.0005	-.0006	.0003	.0003	.0005	.0006	-.0005	-.0010	-.0006	-.0012	.0008	.0014
065	-.0005	-.0006	.0003	.0003	.0005	.0006	-.0005	-.0010	-.0006	-.0012	.0008	.0014
070	-.0005	-.0006	.0003	.0004	.0005	.0006	-.0005	-.0010	-.0006	-.0012	.0008	.0014
075	-.0006	-.0006	.0003	.0004	.0006	.0006	-.0006	-.0012	-.0006	-.0012	.0008	.0014
080	-.0006	-.0006	.0003	.0004	.0006	.0006	-.0006	-.0012	-.0006	-.0012	.0008	.0014
090	-.0006	-.0006	.0003	.0004	.0006	.0006	-.0006	-.0012	-.0006	-.0012	.0008	.0014
100	-.0007	-.0007	.0004	.0004	.0007	.0007	-.0007	-.0014	-.0007	-.0014	.0010	.0016
110	-.0007	-.0007	.0004	.0004	.0007	.0007	-.0007	-.0014	-.0007	-.0014	.0010	.0016
120	-.0007	-.0007	.0004	.0005	.0007	.0007	-.0007	-.0014	-.0007	-.0014	.0010	.0016
140	-.0007	-.0008	.0004	.0005	.0007	.0008	-.0007	-.0014	-.0008	-.0016	.0012	.0018

* Diametral clearance after installation theoretically can range rather widely if all contributing bearing, housing, and shaft tolerances are at either of their extremes. Diametral clearances shown do not apply to Type A (angular contact) bearings.

Listed shaft and housing diameters are for steel supports with standard bearing diametral clearance. Recommended shaft and housing diameters can change greatly based on orientation, temperature, speed, non-standard diametral clearances, and desired performance characteristics. Contact KAYDON for design assistance when required.

All dimensions in inches.

Total Width Tolerance—Duplexed Type A Bearings:
 Up thru 12" Bearing Bore +.000 –.010
 Over 12" Bearing Bore +.000 –.020
 Race Width Tolerance—Single Type C, X, A Bearings:
 Up thru 12" Bearing Bore +.000 –.005
 Over 12" Bearing Bore +.000 –.010

Precision Tolerances and Recommended Fits for REALI-SLIM MM™ Metric Series Bearings shown on pages 54 thru 59

Section 3—Applications Engineering

KAYDON class 1 for A, C, X type bearings All dimensions in millimeters.

Bearing Size (mm Series)	Bearing Diameters		Radial & Axial Runout		Rotating Shaft or Duplex DF Mounting		Stationary Shaft or Duplex DB Mounting				Bearing Diametral Clearance*	
	Bearing Bore Nominal +.0000	Bearing O.D. Nominal +.0000	Inner Race	Outer Race	Shaft Diameter Nominal +.0000	Housing Bore Nominal +.0000	Shaft Diameter Nominal		Housing Bore Nominal		Before Installation	
020	-.010	-.010	.008	.010	+.010	+.010	-.010	-.020	-.010	-.020	0.025	0.038
025	-.010	-.010	.008	.010	+.010	+.010	-.010	-.020	-.010	-.020	0.025	0.038
050	-.012	-.013	.013	.013	+.012	+.013	-.012	-.024	-.013	-.026	0.030	0.056
060	-.015	-.013	.013	.013	+.015	+.013	-.015	-.030	-.015	-.030	0.030	0.056
070	-.015	-.015	.015	.015	+.015	+.015	-.015	-.030	-.015	-.030	0.030	0.056
080	-.015	-.015	.015	.015	+.015	+.015	-.015	-.030	-.015	-.030	0.030	0.056
090	-.020	-.015	.015	.015	+.020	+.015	-.020	-.040	-.020	-.040	0.041	0.066
100	-.020	-.015	.015	.015	+.020	+.015	-.020	-.040	-.020	-.040	0.041	0.066
110	-.020	-.018	.015	.020	+.020	+.018	-.020	-.040	-.020	-.040	0.041	0.066
120	-.020	-.018	.020	.020	+.020	+.018	-.020	-.036	-.020	-.036	0.041	0.066
130	-.025	-.018	.025	.025	+.025	+.018	-.025	-.051	-.018	-.036	0.051	0.076
140	-.025	-.025	.025	.025	+.025	+.025	-.025	-.051	-.025	-.051	0.051	0.076
150	-.025	-.025	.025	.025	+.025	+.025	-.025	-.051	-.025	-.051	0.051	0.076
160	-.025	-.025	.025	.025	+.025	+.025	-.025	-.051	-.025	-.051	0.051	0.076
170	-.025	-.025	.025	.025	+.025	+.025	-.025	-.051	-.025	-.051	0.051	0.076
180	-.025	-.030	.025	.025	+.025	+.030	-.025	-.051	-.030	-.061	0.051	0.076
190	-.025	-.030	.025	.025	+.025	+.030	-.025	-.051	-.030	-.061	0.051	0.076
200	-.030	-.030	.030	.030	+.030	+.030	-.030	-.061	-.030	-.061	0.061	0.086
250	-.036	-.036	.046	.051	+.036	+.036	-.036	-.071	-.036	-.071	0.071	0.100
300	-.036	-.036	.046	.051	+.036	+.036	-.036	-.071	-.036	-.071	0.071	0.100
320	-.036	-.036	.046	.051	+.036	+.036	-.036	-.071	-.036	-.071	0.071	0.100
340	-.036	-.036	.046	.051	+.036	+.036	-.036	-.071	-.036	-.071	0.071	0.100
360	-.036	-.036	.046	.051	+.036	+.036	-.036	-.071	-.036	-.071	0.071	0.100

* Diametral clearance after installation theoretically can range rather widely if all contributing bearing, housing, and shaft tolerances are at either of their extremes. Diametral clearances shown do not apply to Type A (angular contact) bearings.

Total Width Tolerance—Duplexed Type A Bearings:

Up thru 300 mm Bearing Bore +.000 –.254
Over 300 mm Bearing Bore +.000 –.508

Race Width Tolerance—Single Type C, X, A Bearings:

Up thru 300 mm Bearing Bore +.000 –.127
Over 300 mm Bearing Bore +.000 –.254

Listed shaft and housing diameters are for steel supports with standard bearing diametral clearance. Recommended shaft and housing diameters can change greatly based on orientation, temperature, speed, non-standard diametral clearances, and desired performance characteristics. Contact KAYDON for design assistance when required.

All dimensions in millimeters.

Precision Tolerances and Recommended Fits for ULTRA-SLIM® Bearings shown on page 61

KAYDON class 1 for A, C, X type bearings All dimensions in millimeters.

Bearing Size (mm Series)	① Bore and O.D. Tolerances		② Radial and Axial Race Runouts		Rotating Shaft or Duplex DF Mounting		Stationary Shaft or Duplex DB Mounting		Bearing Diametral Clearance*, Type X & C Before Installation	
	Nominal +0.000		Inner Race	Outer Race	Shaft Diameter Nominal +.0000	Housing Bore Nominal +.0000	Shaft Diameter Nominal	Housing Bore Nominal		
035	-0.013		0.010	0.010	35 +0.013/-0.000	41 +0.013/-0.000	34.987 +0.000/-0.013	40.987 +0.000/-0.013	0.030	0.046
060	-0.013		0.013	0.013	60 +0.013/-0.000	66 +0.013/-0.000	59.987 +0.000/-0.013	65.987 +0.000/-0.013	0.030	0.046
070	-0.013		0.015	0.015	70 +0.013/-0.000	76 +0.013/-0.000	69.987 +0.000/-0.013	75.987 +0.000/-0.013	0.030	0.046
074	-0.013		0.015	0.015	74 +0.013/-0.000	80 +0.013/-0.000	73.987 +0.000/-0.013	79.987 +0.000/-0.013	0.030	0.046
080	-0.013		0.015	0.015	80 +0.013/-0.000	86 +0.013/-0.000	79.987 +0.000/-0.013	85.987 +0.000/-0.013	0.030	0.046
090	-0.013		0.015	0.015	90 +0.013/-0.000	96 +0.013/-0.000	89.987 +0.000/-0.013	95.987 +0.000/-0.013	0.030	0.046
100	-0.013		0.015	0.015	100 +0.013/-0.000	106 +0.013/-0.000	99.987 +0.000/-0.013	105.987 +0.000/-0.013	0.030	0.046
110	-0.013		0.020	0.020	110 +0.013/-0.000	116 +0.013/-0.000	109.987 +0.000/-0.013	115.987 +0.000/-0.013	0.030	0.046
120	-0.013		0.020	0.020	120 +0.013/-0.000	126 +0.013/-0.000	119.987 +0.000/-0.013	125.987 +0.000/-0.013	0.030	0.046
130	-0.013		0.020	0.020	130 +0.013/-0.000	136 +0.013/-0.000	129.987 +0.000/-0.013	135.987 +0.000/-0.013	0.030	0.046
140	-0.013		0.025	0.025	140 +0.013/-0.000	146 +0.013/-0.000	139.987 +0.000/-0.013	145.987 +0.000/-0.013	0.030	0.046
150	-0.013		0.025	0.025	150 +0.013/-0.000	156 +0.013/-0.000	149.987 +0.000/-0.013	155.987 +0.000/-0.013	0.030	0.046
160	-0.013		0.025	0.025	160 +0.013/-0.000	166 +0.013/-0.000	159.987 +0.000/-0.013	165.987 +0.000/-0.013	0.030	0.046
170	-0.013		0.025	0.025	170 +0.013/-0.000	176 +0.013/-0.000	169.987 +0.000/-0.013	175.987 +0.000/-0.013	0.030	0.046

① Diameter tolerances apply to average dimensions. Due to the thin nature of these bearings, they cannot be measured with 2 point gauges.

② The runout values apply to individual bearing races.

* Diametral clearance after installation theoretically can range rather widely if all contributing bearing, housing, and shaft tolerances are at either of their extremes. Diametral clearances shown do not apply to Type A (angular contact) bearings.

Race Width Tolerance-Single Type C, X, A Bearings:
All sizes +.000 -.127

Listed shaft and housing diameters are for steel supports with standard bearing diametral clearance. Recommended shaft and housing diameters can change greatly based on orientation, temperature, speed, non-standard diametral clearances, and desired performance characteristics. Contact KAYDON for design assistance when required.

All dimensions in millimeters.

CONTACT KAYDON AT—
KAYDON Corporation • Muskegon, Michigan 49443
Telephone: 231/755-3741 • Fax: 231/759-4102















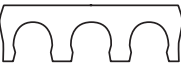

NEED SERVICE FAST?
1-800-514-3066
Website: www.kaydonbearings.com

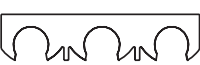
Section 4 — Separator Types, Ball Count, and Performance

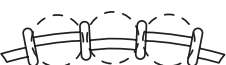
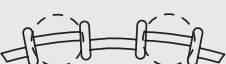

	Page Number
• Separator Types	93
• Number of Balls in Standard Bearings	97
• Performance	98
- Limiting Speeds	
- Torque	
- Axis Deviation	
- Deflection Curves	

Overview of Separator Types Used in REALI-SLIM® Bearings

Code Letter*	Description	Design Features	Precautions	Material	Design
P	One piece formed ring with "snapover" pockets.	Standard ball complement. Used in Type C and X bearings for "KA" through "KG" cross-section bearings.	Commercial type cage, not recommended for low torque applications. Consult factory for temperatures below -65°F and above 250°F.	Brass or non-metallic composite.	
R	One piece formed ring with circular pockets.	Standard ball complement. Used in Type A bearings for "KA" through "KG" cross-section bearings.	Commercial type cage, not recommended for low torque applications. Consult factory for temperatures below -65°F and above 250°F.	Brass or non-metallic composite.	
L	One piece molded ring with "snapover" pockets.	Standard ball complement. Used in Type C and X KAA cross-section bearings.	Consult factory for temperatures below -65°F and above 250°F.	Nylon. Fiberglass reinforced.	
G	One piece molded ring with circular pockets.	Standard ball complement. Used in Type A KAA cross-section bearings.	Consult factory for temperatures below -65°F and above 250°F.	Nylon. Fiberglass reinforced.	
D	One piece machined ring with "snapover" pockets.	Standard ball complement. Used in Type C and X bearing when low torque, lightweight or vacuum impregnation is required.	Not recommended above 250°F. Longer lead time and higher cost than "P" type separators.	Phenolic laminate.	
H	One piece machined ring with circular pockets.	Standard ball complement. Used in Type A bearing when low torque, lightweight or vacuum impregnation is required.	Not recommended above 250°F. Longer lead time and higher cost than "R" type separators. Use toroid ball spacer when possible.	Phenolic laminate.	
N	Molded strip with "snap over" pockets	Slightly higher ball count, used in Type C and X bearings. Available for all diameters over 4 inches.	Shaft or housing protrusions can grab separator and remove from bearing. 180°F max suggested operating temp.	Nylon 12	
J	Molded strip with circular pockets	Slightly higher ball count, used in Type A bearings. Available for all diameters over 4 inches.	180°F max suggested operating temp.	Nylon 12	
X	One piece molded ring with "snap over" pockets	Excellent for vacuums	Limited availability	PEEK	
Q	One piece molded ring with circular pockets	Excellent for vacuums	Limited availability	PEEK	
M	Formed wire strip or segmental cage with "snapover" pockets.	Increased ball complement. Used in Type A, C, and X bearings for greater capacity (approx. 150%) and higher temperature.	Higher torque and lower speed capability than "R" type separators. Comparatively high wear rate. Requires loading notch for "C" and "X" bearings.	17-7 PH stainless steel	
W	Formed wire strip or segmental cage with "snapover" pockets.	Used in Type C and X bearings for high temperature applications. Standard ball complement.	Higher torque and lower speed capability than "R" type separators. Comparatively high wear rate.	17-7 PH stainless steel	
F	Full complement bearing.	Max. ball complement. Used in Type C, X, and A bearings for maximum capacity and stiffness.	High torque and low limiting speed due to ball rubbing. Not recommended for dynamic applications. Loading notches are required for "C" and "X" bearings.	Steel (Per ABMA Standard 10).	
S	Helical coil spring.	Reduced ball complement. Used in Type C and X bearings for low torque and high temperature.	Increased assembly cost. Should only be considered when PTFE spacer slugs cannot be used. Slow speed and light load only.	300 Series stainless steel.	
Z	Spacer slugs.	Standard ball complement. Used in Type C or X bearings for low torque. Prevents separator wind-up.	Not recommended for temperatures greater than 250°F or speeds in excess of 500 ft/min pitch line velocity. (Example: KA040C20 max speed = 450 rpm).	PTFE tubing	
Z	Toroid ball spacers.	Increased ball complement. Used in Type A bearings for low torque. Prevents separator wind-up.	Not recommended for speeds greater than 500 ft/min pitch line velocity. PTFE is limited to 250°F. Vespel® is limited to 500°F.	PTFE or Vespel® SP-1 polyamide plastic.	
Z	Spacer ball.	Requires a loading notch for C and X assembly. Low speed capability. Relatively high torque.	Increased ball complement. Used in Type A bearings for low torque. Prevents separator wind-up.	Steel per ABMA Standard 10. (Spacer balls are smaller than load carrying balls.)	

Section 4—Separators, Balls, Performance

*Code descriptions are Position 7 of bearing identification number - see page 3.

Separator Types

The principal function of a bearing separator is to space the rolling elements uniformly, thereby preventing contact between them. Minute differentials in rolling element motion result from differences in individual rolling element loads and the inherent elasticity of bearing and mounting components. Without a separator some rolling elements will eventually contact each other. Due to the shape of the rolling elements and the opposite direction of motion of the contacting surfaces, a combination of relatively high contact stress and rapid motion is possible. Consequent abrasion of the rolling elements and residue of wear in the raceways affect life and torque characteristics, limiting the use of full complement bearings to slow speed applications where relatively large torque variations can be tolerated.

KAYDON separators for REALI-SLIM® bearings are designated by a single letter character in coded part numbers (page 3), standard P, R, L, and G separators have proved to be suitable for a wide range of operating conditions. Requirements, however, may dictate the use of different materials. This may affect capacities. For assistance in selecting REALI-SLIM® bearings, contact KAYDON Engineering. Operating temperatures for various separator materials are shown on page 93.

Continuous Ring “Snapover Pocket” Separator

Figure 4-1 - Snapover Pocket

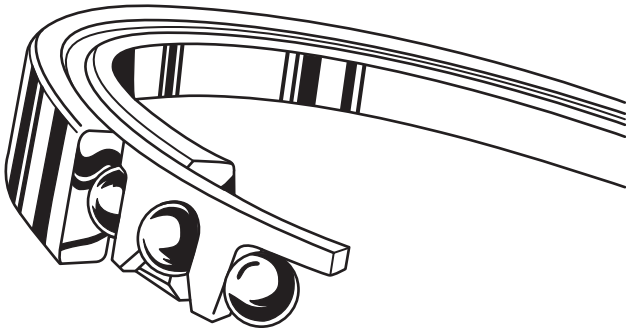

Designed for use in bearing types C and X, this style is installed after Conrad assembly of the races and balls. The tangs of the alternate “snap” pockets deform elastically to snap over the balls for retention of the separator. Centered on the balls at room temperature, the separator becomes outer race land riding or inner

race land riding when temperatures cause differential thermal expansion or contraction.

Close control of roundness and wall thickness insures effective piloting in either case, limiting separator “whip” and friction between the separator and race lands for smooth operation.

Different materials are available for unusual operating conditions including stainless steel and non-metallics such as phenolic laminate, PTFE, and PEEK.

- Stainless steel separators are used in stainless steel bearings or high temperature applications for corrosion resistance.
- Phenolic laminate is used where light weight and/or lubricant absorption is desired.
- The “snap-over” non-metallic separator is ideal for high-speed applications of bearings too small in cross section for the two-piece riveted design (bearing Series C and lighter sections). It is also desirable in low speed, minimum torque applications.

For more information on how to use our bearings, contact KAYDON Engineering.

Orientation

It is suggested that in an application where the bearing axis will be within 45° of vertical, the bearing be positioned with separator pocket openings down or that a shoulder of the shaft or housing be extended as added assurance of retention. Sealed and shielded bearings have this orientation instruction etched on the O.D. by an arrow and the word “up” as shown below.

Figure 4-2

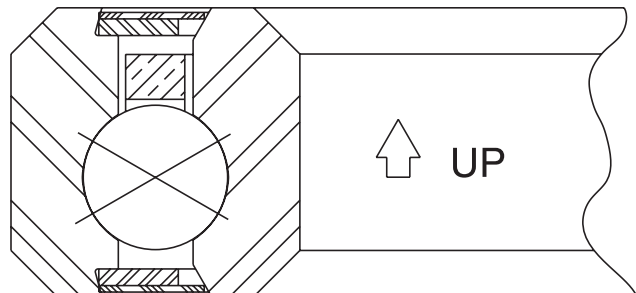

Correct bearing orientation is shown.

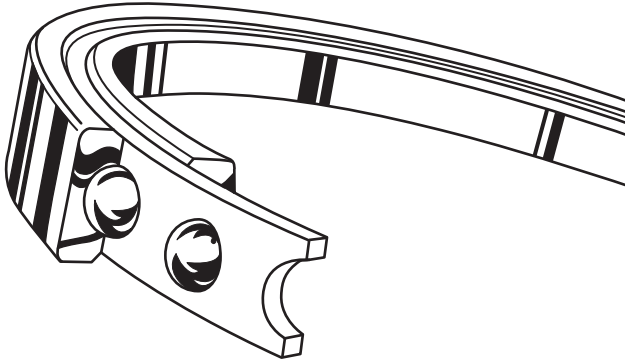
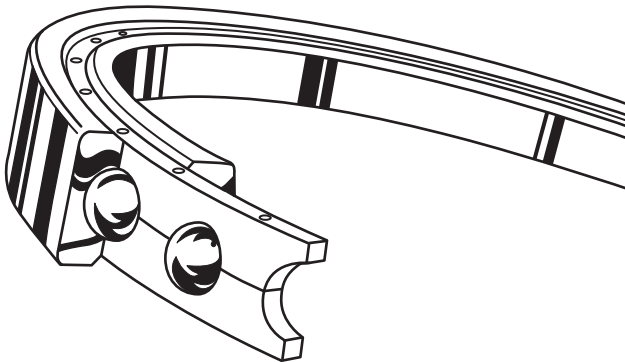
SEPARATOR TYPES (continued)**Continuous Ring Circular Separators****Figure 4-3 - Continuous Ring Pocket****Figure 4-4 - Riveted Ring Circular Pocket**

Designed for use in Type A bearings, the one-piece separator shown in Figure 4-3 is positioned around the inner race with the balls placed in pockets before the outer race is expanded thermally and dropped over the balls. This method of assembly permits the use of more balls than in the Conrad bearing Types C and X. In addition to the standard separators of brass, non-metallic composite and reinforced nylon, this style can be furnished in phenolic laminate, stainless steel, and aluminum.

Designed for use in non-standard bearings of Type C or Type X, the separator shown in Figure 4-4 is installed after Conrad assembly of the races and bearing and riveted together. Because of the space required for rivets, use is limited to Series D and heavier sections. Usually machined all over, this style is recommended in

phenolic laminate for very high speeds. Where very high strength is required, it is furnished in bronze, aluminum, or stainless steel.

As in the case of the continuous ring "snapover" pocket separator, both of these styles are centered on the balls at room temperature, becoming either outer race land riding or inner race land riding as the temperature changes.

Segmental Separators

Segmental separators of either the ring or "snapover" design offer advantages for certain applications.

1. When larger diameter bearings are subjected to high temperatures, expansion differentials between the separator and the races may exceed the normal clearances provided.
2. When oscillatory motion, variable loading and a vertical axis combine to cause differential ball travel with no "vacation zone," torque may become objectionably high or erratic.

A segmental separator may consist of a one-piece open ring or it may be composed of two or more segments. Where differential expansion creates a problem, sufficient clearance is provided between the ends of the open ring or between the several segments to allow for this expansion. Where torque is of concern, the selection of the number of segments is made based upon experience. In all other respects, segmental separators satisfy the above descriptions for **Continuous Ring "Snapover Pocket" Separators or Continuous Ring "Circular Pocket" Separators**.

Segmenting the separator imposes somewhat greater restrictions on the bearings. Maximum allowable speed of rotation is reduced due to the centrifugal force ("brake banding") energized by the segments against the outer race lands. Also, in the case of the "snapover pocket" style, a shaft or housing shoulder should be extended to assure retention of the separator irrespective of the operating position of the bearing. See next page.

SEPARATOR TYPES (continued)

Formed Wire Separator

Figure 4-5

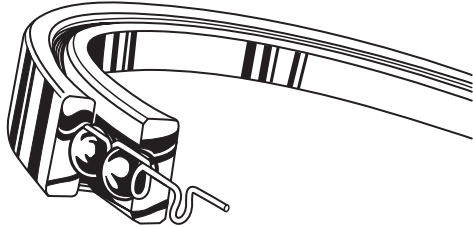

When the need exists for maximum capacity and thus the greatest possible number of balls, a formed wire separator may be used to avoid the disadvantages of a full complement bearing. It has been most successfully employed in Type A bearings, where the greater number of balls can be installed without resorting to use of a loading slot. Use in bearing Types C and X should be restricted to very low speed applications.

Comparatively high wear rate coupled with relatively light section can cause the wear life of the wire separator to be a limiting factor in the life a bearing, especially if the loads are high. However, where weight or space are at a premium and the added capacity is an important consideration, this separator may be considered a good compromise.

A bearing with a wire separator and maximum allowable ball complement has a static load capacity of 180% of the catalog static rating.

Toroid Separators

Figure 4-6A

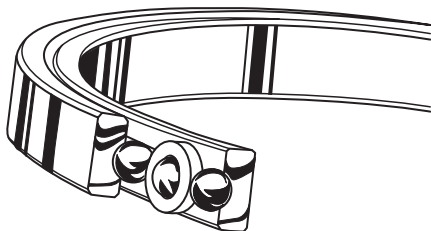

PTFE Spacer Slugs

Figure 4-6B

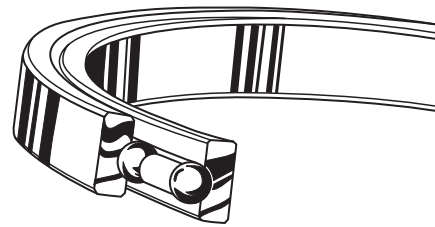

Spacer Balls

Figure 4-6C

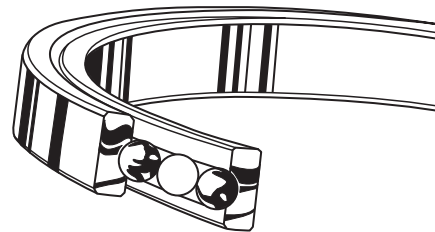

Helical Spring Separators

Figure 4-6D

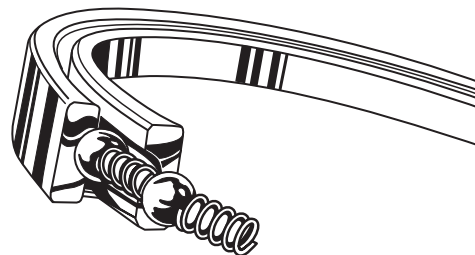

In some critical positioning applications, uniformity of torque is more important than the actual mean torque level. Specially designed toroids (Figure 4-6A), PTFE spacer slugs (Figure 4-6B), spacer balls (Figure 4-6C) or helical compression springs (Figure 4-6D) have proved in a number of such instances to be satisfactory for ball separation—by their nature they give a large amount of individual and cumulative circumferential freedom to the balls. To prevent this freedom from being abused, however, speeds must be low and loads comparatively light.

Applications involving use of these separators should be referred to KAYDON for review and recommendation.

Section 4—Separators, Balls, Performance

Number of Balls in Standard REALI-SLIM® Bearings

Figure 4-7

Boring Size	Type A							Types C and X						
	CAA	KA	KB	KC	KD	KF	KG	CAA	KA	KB	KC	KD	KF	KG
010	28							21						
015	40							29						
017	44							33						
020		36	31						27	23				
025		44	38						33	28				
030		52	44						39	33				
035		60	51						45	38				
040		68	58	49	36	26	20		51	43	35	27	19	15
042		72	61	52	38	27	21		54	45	37	28	20	15
045		76	64	55	40	29	22		57	48	39	30	21	16
047		80	68	58	42	30	23		60	50	41	31	22	17
050		84	71	61	44	31	24		63	53	43	33	23	18
055		92	78	66	48	34	26		69	58	47	36	25	19
060		100	85	72	52	37	28		75	63	51	39	27	21
065		108	91	78	56	40	30		81	68	55	42	29	22
070		116	98	83	60	43	32		87	73	59	45	31	24
075		124	105	89	64	45	34		93	78	63	48	33	25
080		132	112	95	68	48	36		99	83	67	51	35	27
090		148	125	106	76	54	40		111	93	75	57	39	30
100		164	139	118	84	59	44		123	103	83	63	43	33
110		180	152	129	92	65	48		135	113	91	69	47	36
120		196	166	140	100	70	52		147	123	99	75	51	39
140			192	163	116	81	60			143	115	87	59	45
160			219	186	132	92	68			163	131	99	67	51
180			246	209	148	104	76			183	147	111	75	57
200			273	231	164	115	84			203	163	123	83	63
210					172							129		
220							92							69
250				288	204	142	104				203	153	103	78
300				345	244	170	124				243	183	123	93
350						198	144						143	108
400						226	164						163	123



KAYDON software for
REALI-SLIM® bearings
available at:
www.kaydonbearings.com

Limiting Speeds

The following limiting speed information is provided for reference only. For actual speeds, use the REALI-DESIGN™ software found on our website, www.kaydonbearings.com.

The determination of maximum safe operating speeds is largely empirical. Various complex factors play a part in limiting the speed of rotation, some of which are:

- Bearing diameter
- Ratio of bearing diameter to cross-section
- Bearing type and internal configuration
- Ratio of ball groove radius to ball diameter
- Bearing internal fit-up (diametral clearance or preload)
- Operating contact angle(s)
- Bearing precision (runouts)
- Ball separator material and design
- Precision of mount (roundness, flatness under load)
- Lubrication
- Ambient temperature and provision for heat dissipation
- Seals
- Loads
- Life requirement

While precise speed limits cannot be set, experience in actual applications and in the KAYDON test laboratories can serve as a basis for setting general limits. Figure 4-10 takes into account some of the factors and assumes proper installation and adequate provision for heat dissipation. These limits are based upon achieving the full service life of 1,000,000 revolutions. If a shorter life is acceptable, higher speeds may be tolerated, except for bearings using formed wire and helical spring separators.

For speeds near or over the limits in the table, special attention must be given to lubrication and heat. Greases should be of types specially formulated for high speed bearings. Frequency of regreasing must be adequate to insure presence of lubricant at all times. If oil is used, viscous drag should be minimized by controlling the level, using slingers and/or metering small amounts as a liquid or mist. Windage effects at high speeds can make the introduction of oil to the critical surfaces very difficult, and the design of the lubrication system then becomes important. Please consult lubrication manufacturer.

Generally speaking, operating temperature will be limited by the allowable maximum temperature for the lubricant. If, however, bearing temperature is expected to exceed 250°F for extended periods, the bearings should be given stabilization treatment by KAYDON. This treatment will permit operation at temperatures up to 400°F.

While maximum temperature is important, consideration must also be given to possible temperature differential across the bearing. Generally, heat is lost through the housing at a higher rate than through the shaft. The housing fit and the bearing internal clearance before installation must be sufficient to allow for this as well as for the shaft fit if the necessary running clearance is to be realized.

Examples of Limiting Speed Calculations

Example 1 (Standard Bearing)

Limited speed calculation for bearing part number KG040XP0.

Conditions: light thrust loads (<20%), grease lubrication.

From Figure 4-8: slimness symbol = I

From Figure 4-9: derating factor = 1.0

From Figure 4-10: Type X; Separator P; Grease; Class 1; Charted figure = 9

$$\text{Calculation: } N = \frac{(1.0) (9) (1000)}{4} = 2,250$$

Example 2 (High Performance Bearing)

Limiting speed calculation for bearing number KD100AH6.

Conditions: loading at 25%, oil lubrication

From Figure 4-8: slimness symbol = II

From Figure 4-9: derating factor = 0.9

From Figure 4-10: Type A; Separator H; Oil; Class 6; Charted figure = 32

$$\text{Calculation: } N = \frac{(0.9) (32) (1000)}{10} = 2,880$$

LIMITING SPEEDS (continued)

Figure 4-8 - Slimness Symbol (S_s)

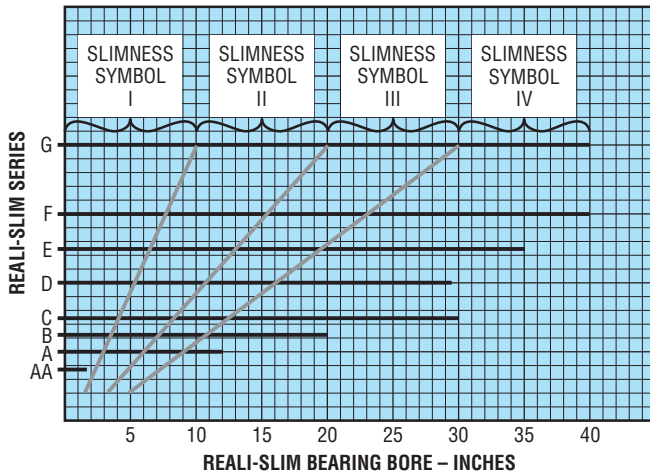

Limiting Speeds for Unsealed Lightly Loaded REALI-SLIM® Ball Bearings

$$\text{Limiting Speed (N)} = \frac{(F_i) (C_f) (1000)}{D}$$

where

D = Bearing bore in inches

N = RPM

Figure 4-9 - Derating Factor (F₁)

For bearings loaded to following percent of dynamic rating	Multiply DN values by following factors
20	1.0
33	.9
50	.8
67	.7
100	.5
150	.2

Figure 4-10 - Charted Figures (C_f)

Bearing Type	Load Conditions	Separator Type	PRECISION CLASS AND LUBRICATION																			
			CLASS 1, 3 & 4								CLASS 6											
			GREASE				OIL				GREASE				OIL				OIL MIST			
Slimness Symbol from Figure 4-8			I	II	III	IV	I	II	III	IV	I	II	III	IV	I	II	III	IV	I	II	III	IV
C with Diametral Clearance	Radial	P, L, X	15	12	9	6	21	18	15	12	21	18	15	12	27	24	21	18	30	27	24	21
		K	20	16	12	8	28	24	20	16	28	24	20	16	36	32	28	24	40	36	32	28
A Spring Loaded or Axially Adjusted	Radial and/or Thrust	R	15	12	9	6	21	18	15	12	21	18	15	12	27	24	21	18	30	27	24	21
		G, H	20	16	12	8	28	24	20	16	28	24	20	16	36	32	28	24	40	36	32	28
		M	8	6	5	3	11	9	8	6	11	9	8	6	14	12	11	9	15	14	12	11
X with Diametral Clearance	Thrust Only	P, L, X	9	8	7	6	11	10	9	8	11	10	9	8	14	12	11	9	15	14	12	11
	Radial Only or Combined Loading	P, L, X	3.0	2.5	2.0	1.5	4	3.5	3	2	4	3.5	3	2	4.5	4	3.5	3	5	4.5	4	3.5

Torque Considerations

Section 4—Separators, Balls, Performance

Torque, as it applies to bearings, is defined as the moment required to turn the rotating race with respect to the stationary race.

Usually the torque requirement of a ball bearing is only a small part of the demand of a mechanical system. In many REALI-SLIM® bearing applications, however, masses and consequent inertias are slight and the amount of work being done is not great. In such cases, it may be important to know as accurately as possible how much turning effort must be provided.

Many factors contribute to the resistance to rotation of a lightly loaded anti-friction bearing, and most of this resistance comes from the more unpredictable ones—separator drag; viscous drag of the lubricant; minute deviations from true geometry in the balls, race ways, and mounting surfaces of bearing, shaft, and housing; internal fit-up of the bearing; and the presence of contaminants.

Bearings can be furnished to a maximum torque level specification.

In the selection of the lubricant and lubricating system, their effects on torque should be kept in mind. To be considered are operating temperatures; speeds of rotation; type, viscosity and quantity of lubricant. All are major factors in determining lubricant drag. Please consult lubrication manufacturer.

In tolerancing the shaft and housing it is important to set limits for out-of-roundness and out-of-flatness of the bearing seats. For normal requirements a good rule

of thumb is to use the bearing radial and axial runout tolerances as the respective limits. For critical torque applications, closer tolerances should be specified since even a very small amount of localized internal preload (negative clearance) will create surprisingly large ball loads and consequent high torque. Where torque must be minimized it is important to limit out-of-roundness of housing or shaft to values which will insure against complete loss of internal clearance.

Cleanliness is extremely important in maintaining uniformity of torque as well as a low level of torque. Very small amounts of microscopic particles of lint, dust, and other common contaminants can cause bearing torque to vary several hundred percent in just a few degrees of rotation. For this reason bearings should be kept in their original unopened package until time for installation. Every effort should be made to protect them from foreign matter, whether or not torque is critical.

The accompanying charts show approximate torque levels of REALI-SLIM® bearings under stated conditions. Estimates can be furnished for more unusual situations. Information submitted should contain all operating conditions of load, speed, lubricant, and environment including temperature together with a print of the intended mounting, showing materials and radial sections. If a limit has been set on permissible system error in terms of axis deviation—radial translation, axial translation, or angular rotation (page 102) — this information should also be submitted.

Additional processing is used to achieve the lowest possible torque levels. High precision races and balls, super-finished ball tracks, and precisely set internal fit-ups assure optimum performance.

- Low-torque ball separators
- Clean-room assembly
- Factory-lubricated bearings
- ABMA Grade 10 balls
- Super-finish ball track

Materials

Races	AISI 52100 (Precision Class 6)
Balls	AISI 52100 (Grade 10)
Cage (Type A)	PTFE or Vespel® toroid ball spacers
Cage (Types C, X)	Slugs

Starting Torque vs. Load

Computer generated torque curves for mounted REALI-SLIM® bearings can be provided by KAYDON Product Engineering

Figure 4-11

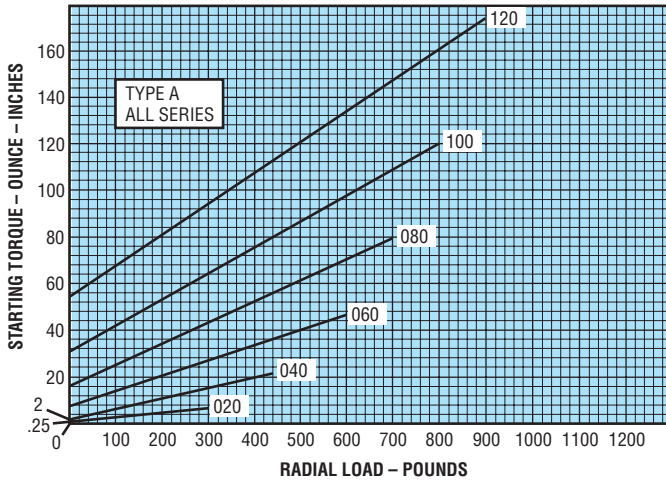

Figure 4-13

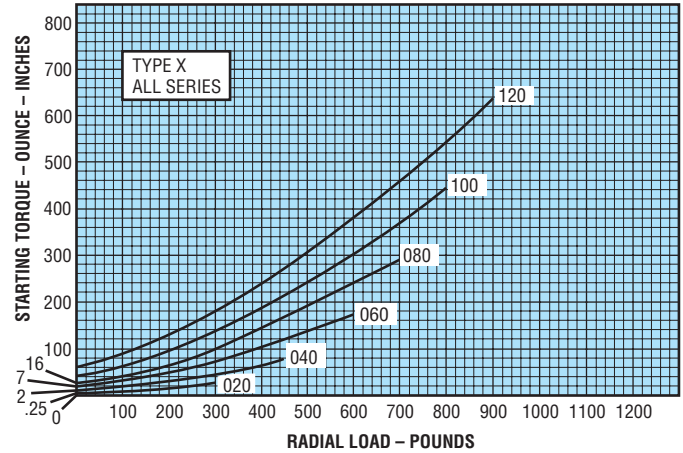

Figure 4-12

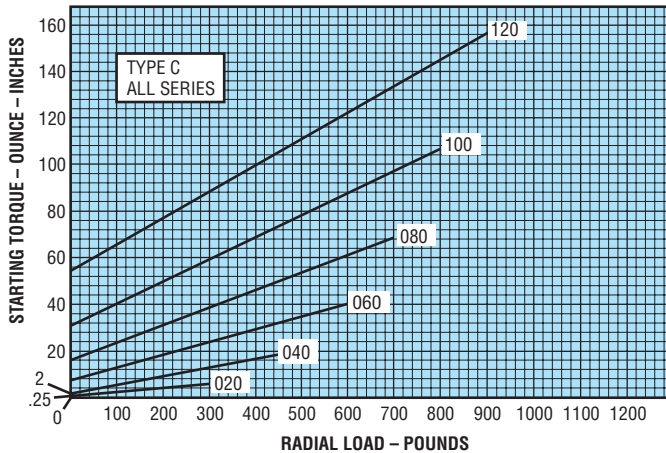
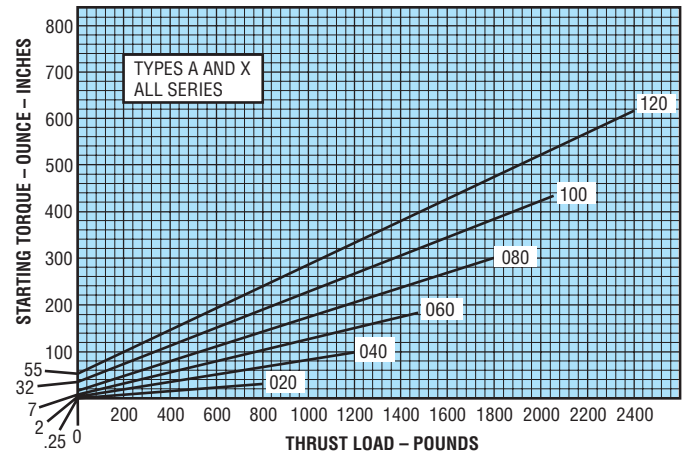

Figure 4-14



Notes Applying to These Charts

- Values shown are statistical ratings* based on:
 - KAYDON Precision Class 1 bearings with some internal clearance remaining after installation
 - A rigid mounting, round and flat within respective radial and axial bearing runout limits
 - Light oil lubrication
 - Room temperature

- Running torque at speeds up to 10 RPM usually averages from 25 to 50% of starting torque, and increases with increasing speed to as much as 200% at maximum allowable diametral clearance (page 103).
- Interpolate for intermediate sizes.
- Curve number indicates bearing bore in tenths of an inch.

*Usually not more than 10% of a group of bearings will have torque demands higher than those shown.

Bearing Axis Deviation Due to Clearance And Deflection

REALI-SLIM® bearings are often used in applications where the position of a rotating part relative to the stationary structure is critical. Knowledge of the displacement of the axis of rotation and the factors contributing to it are thus important.

The axis of rotation can be displaced from its true position in three ways—radially, axially, and angularly. These deviations are referred to as radial translation, axial translation, and tilt (angular rotation) respectively.

In addition to the obvious effects of bearing runout, total deviation of bearing axis in any one of the above conditions is due to the effects of bearing diametral clearance and elastic deflection (deformation) at the ball or roller contacts. The diametral clearance after installation changes due to the combined effects of external fitting practice, differential thermal expansion or contraction of the bearing races and mounting structures, and relative rigidity of the races and mating parts.

Elastic deflection at the ball or roller contacts results from the externally applied bearing loads and is influenced by ball or roller diameter, race groove radius, raceway diameters, and contact angle.

The following three equations are given to aid in determining displacement. The internal diametral clearance (DC) must be calculated or approximated. The remaining independent variables can be obtained from the graphs on pages 104 through 109.

$$RT = RD + \frac{DC}{2}$$

$$AT = AD + \frac{AC}{2}$$

$$AR = MD + AC/PD$$

Where:

$$RT = \text{Radial Translation} \quad \text{— in inches}$$

$$AT = \text{Axial Translation} \quad \text{— in inches}$$

$$AR = \text{Angular Rotation} \quad \text{— in inches/ inch or radians}$$

$$RD = \text{Radial deflection due to radial load} \quad \text{— in inches}$$

$$AD = \text{Axial deflection due to axial load} \quad \text{— in inches}$$

$$MD = \text{Moment deflection due to moment load} \quad \text{— in inches/ inch or radians}$$

$$DC = \text{Diametral clearance} \quad \text{— in inches}$$

$$AC = \text{Axial clearance} \quad \text{— in inches}$$

$$PD = \text{Pitch diameter} \quad \frac{\text{O.D.} + \text{Bore}}{2} \quad \text{— in inches}$$

The equations may be used in applications where the radial, axial, or moment load is applied singly or where one type of loading predominates. For assistance in selecting REALI-SLIM® bearings, contact KAYDON Engineering.

Computer-generated reports and graphs for REALI-SLIM® bearings are available from KAYDON engineering and from our REALI-DESIGN™ computer software, available for download at www.kaydonbearings.com.

Axial Clearance vs. Diametral Clearance

Figure 4-15

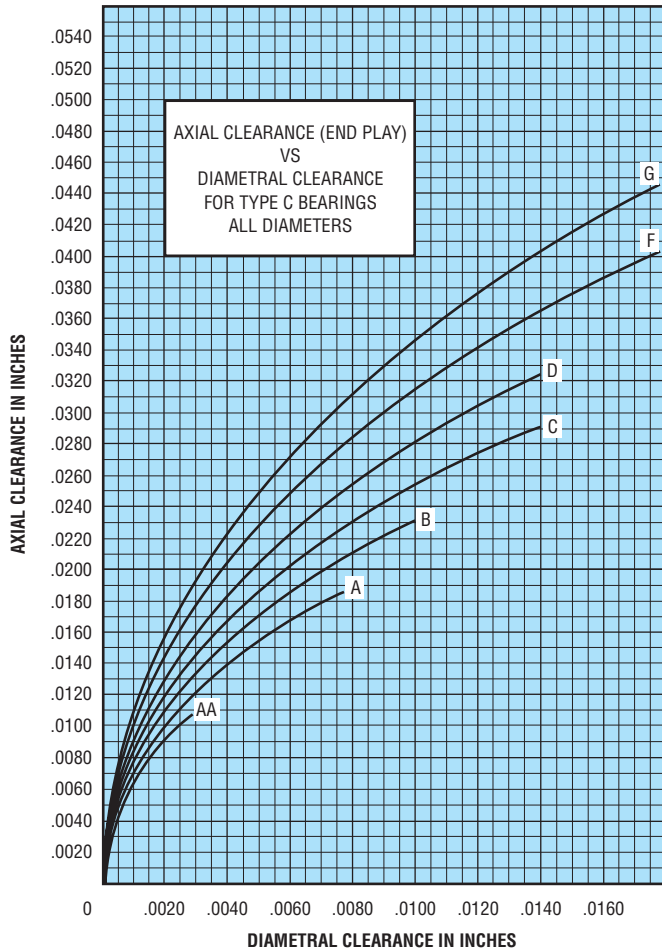
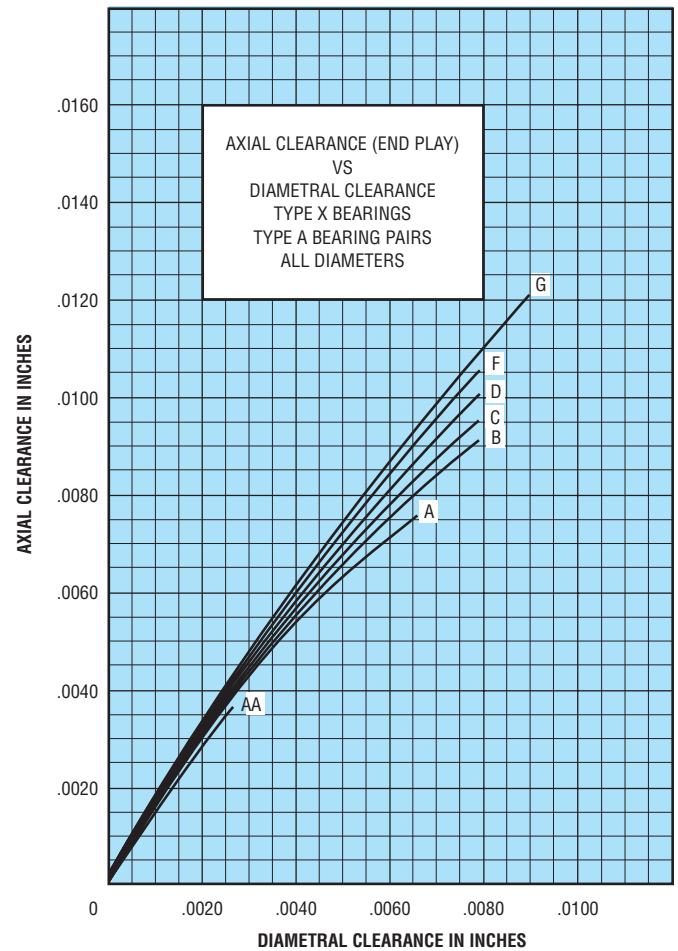

Figure 4-16



CONTACT KAYDON AT—
 KAYDON Corporation • Muskegon, Michigan 49443
 Telephone: 231/755-3741 • Fax: 231/759-4102

NEED SERVICE FAST?
1-800-514-3066
 Website: www.kaydonbearings.com

Axial Deflection vs. Axial Load

Type A Angular Contact

For more detailed information, use KAYDON REALI-DESIGN™ software

Figure 4-17

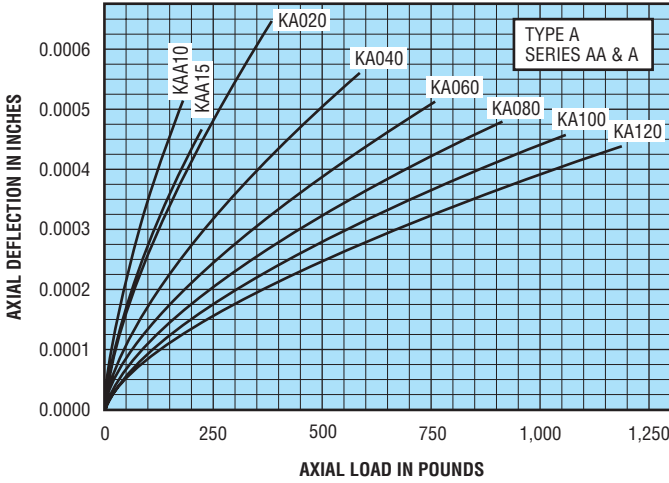

Figure 4-20

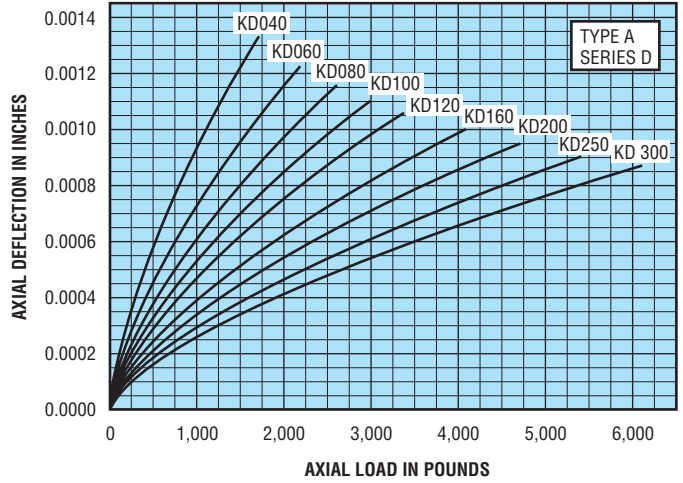

Figure 4-18

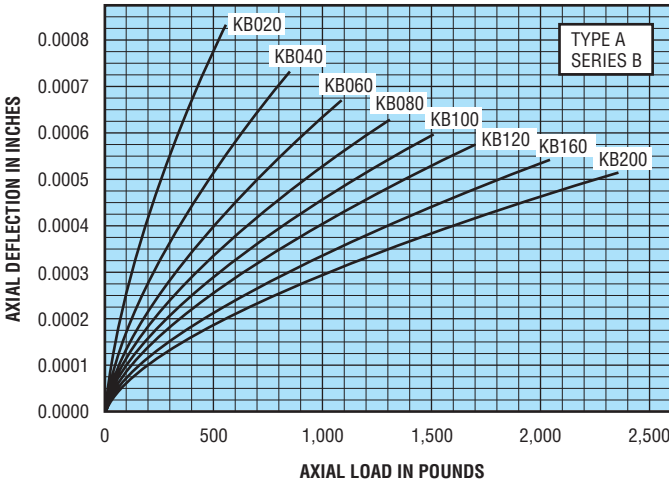

Figure 4-21

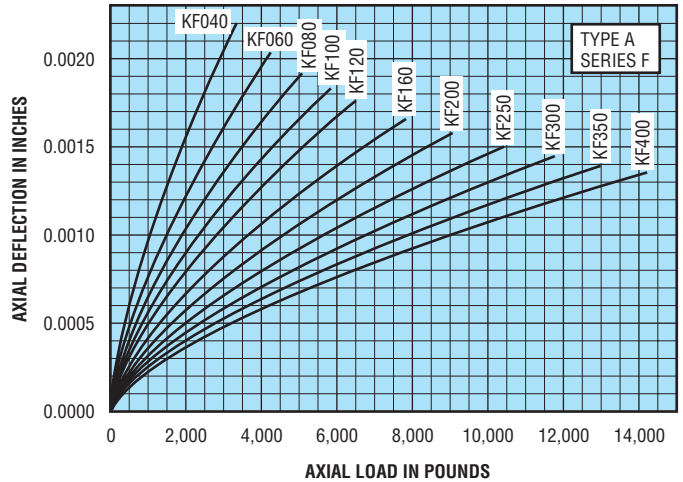

Figure 4-19

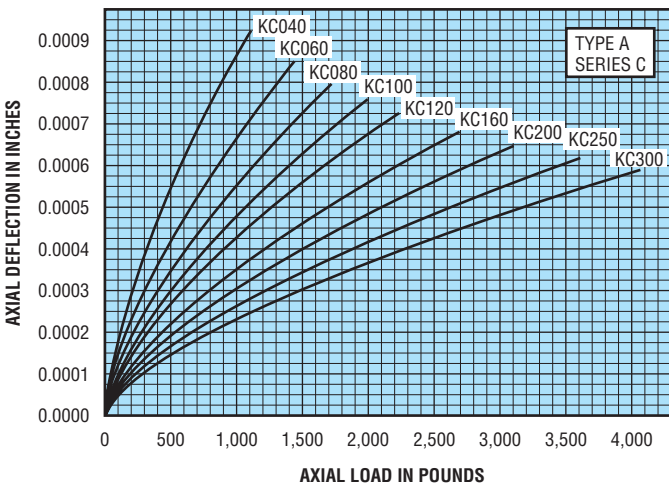
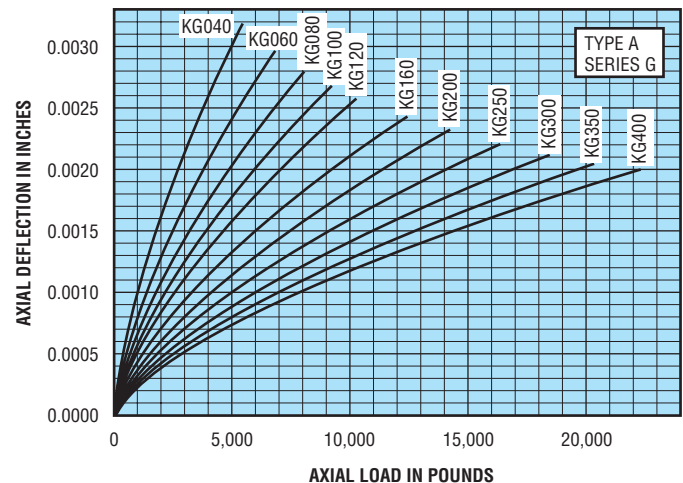

Figure 4-22



Section 4—Separators, Balls, Performance

Radial Deflection vs. Radial Load

Type A Angular Contact

For more detailed information, use KAYDON REALI-DESIGN™ software

Figure 4-23

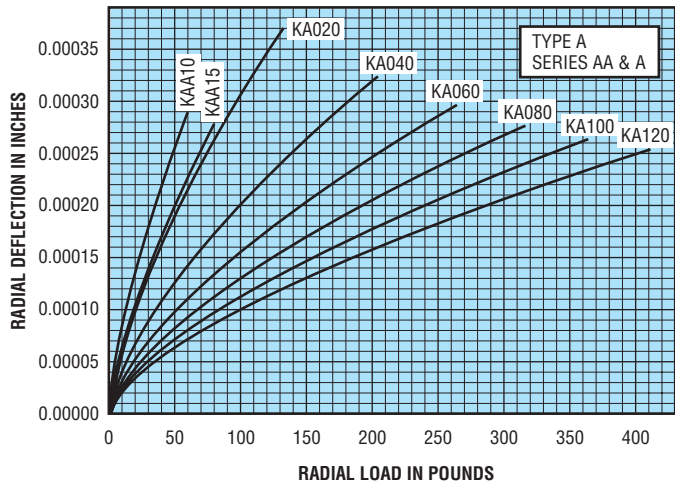

Figure 4-26

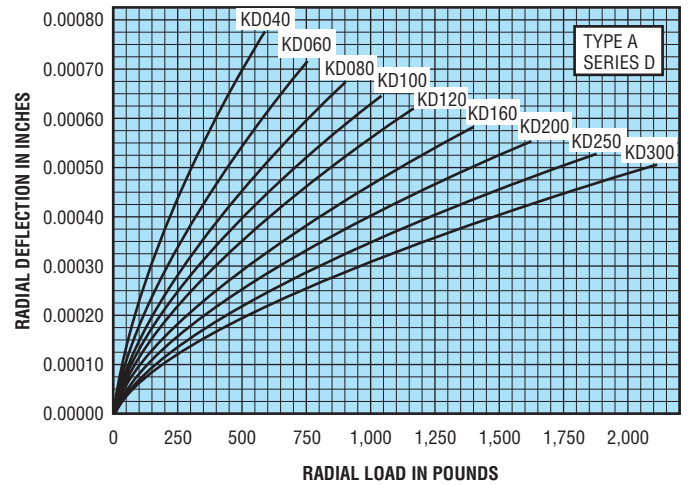

Figure 4-24

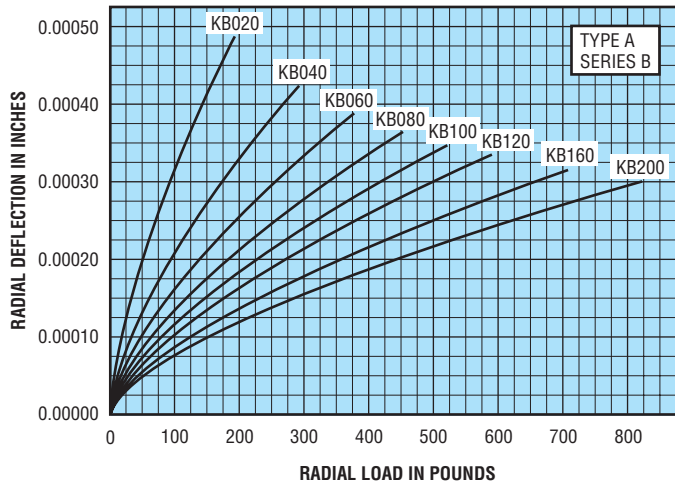

Figure 4-27

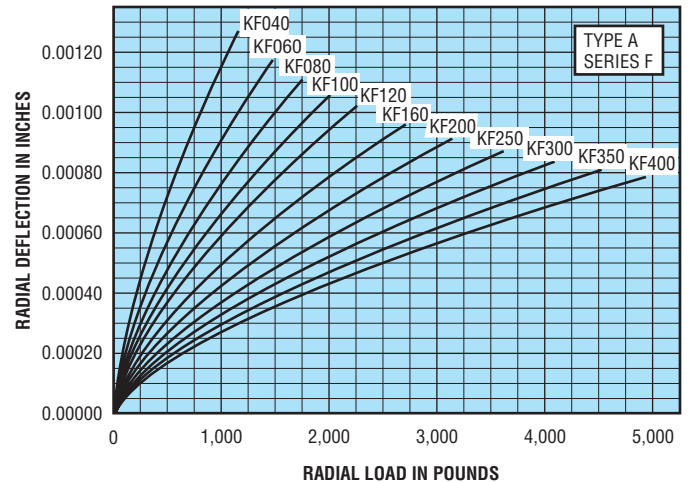

Figure 4-25

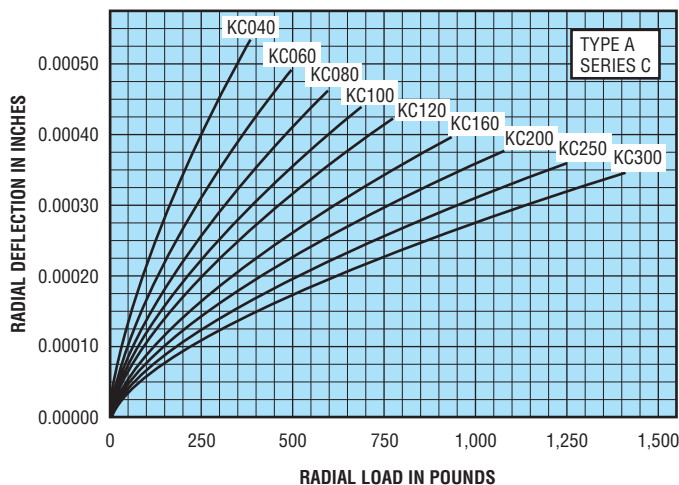
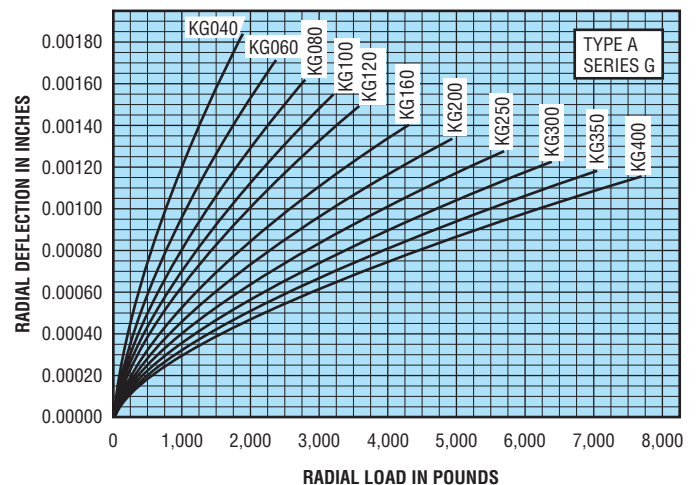

Figure 4-28



Radial Deflection vs. Radial Load

Type C Radial Contact

For more detailed information, use KAYDON REALI-DESIGN™ software

Figure 4-29

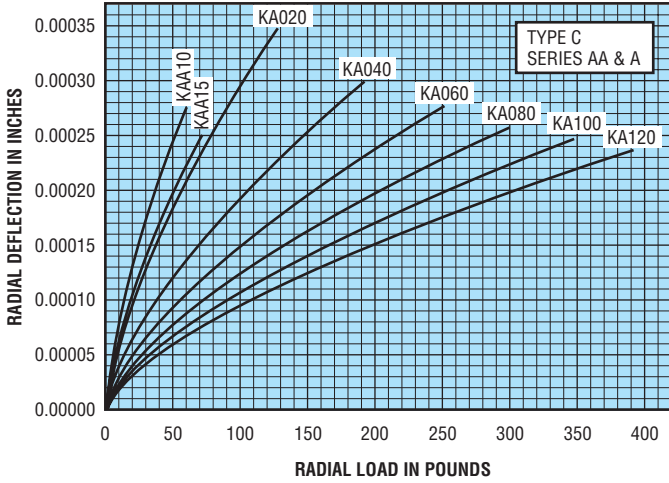

Figure 4-32

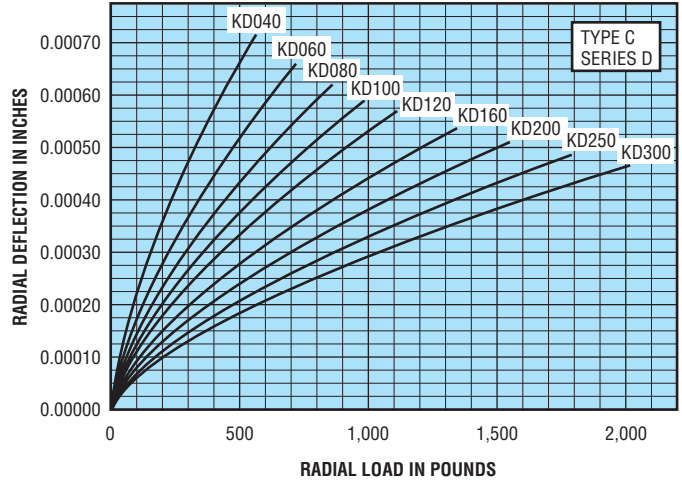

Figure 4-30

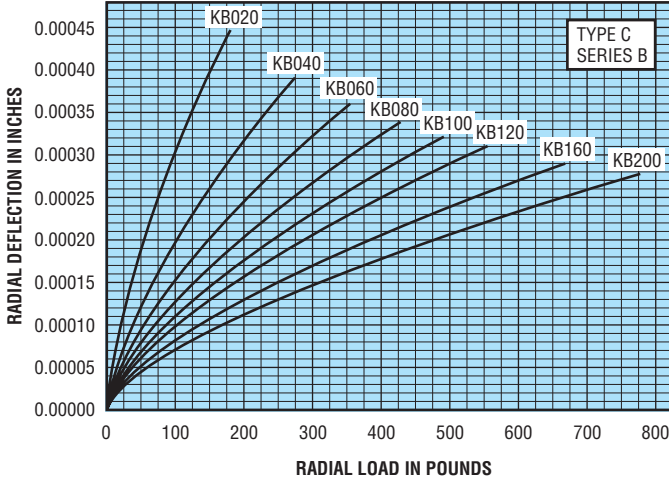

Figure 4-33

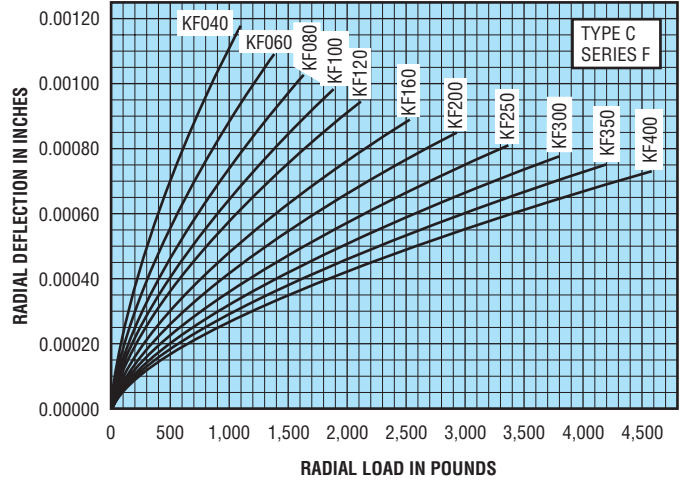

Figure 4-31

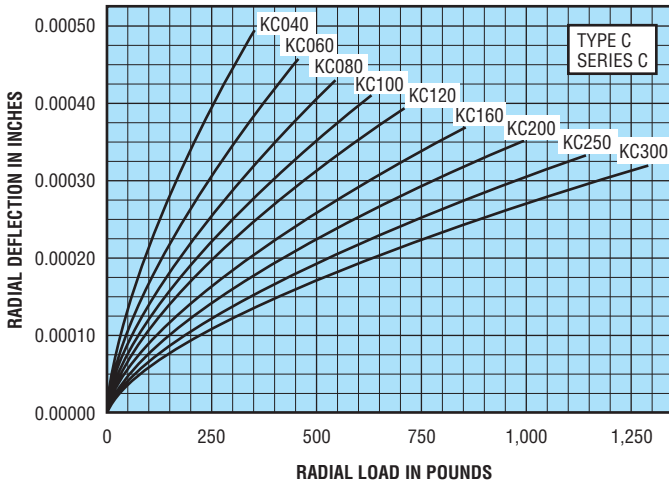
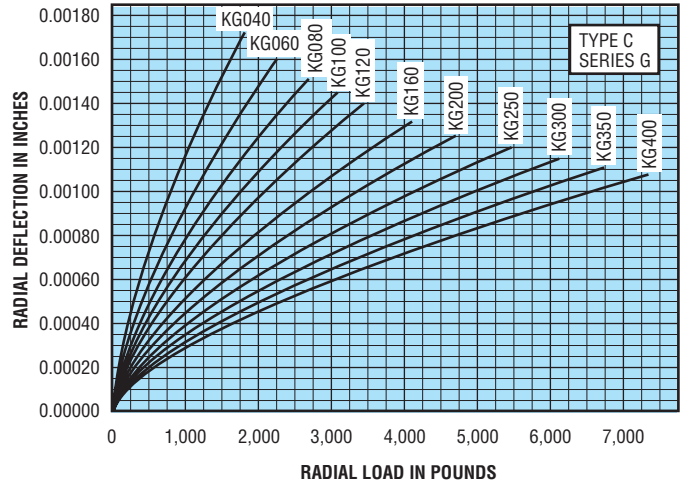

Figure 4-34



Axial Deflection vs. Axial Load

Type X Four-Point Contact

For more detailed information, use KAYDON REALI-DESIGN™ software

Figure 4-35

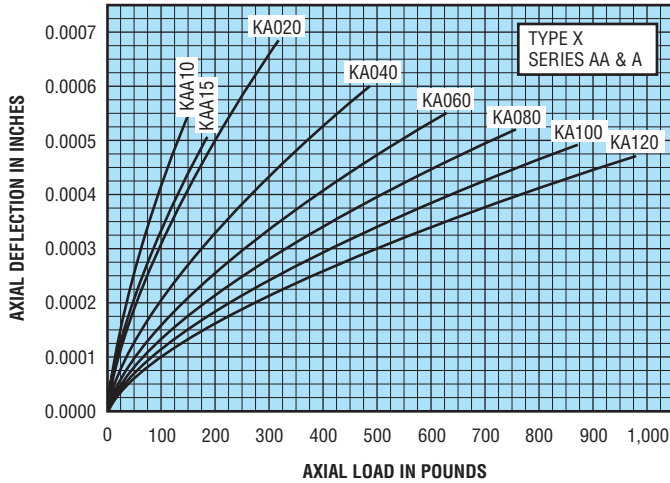

Figure 4-38

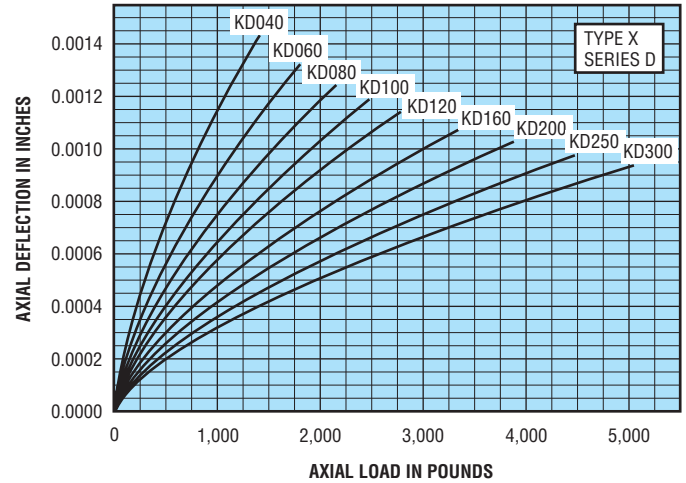

Figure 4-36

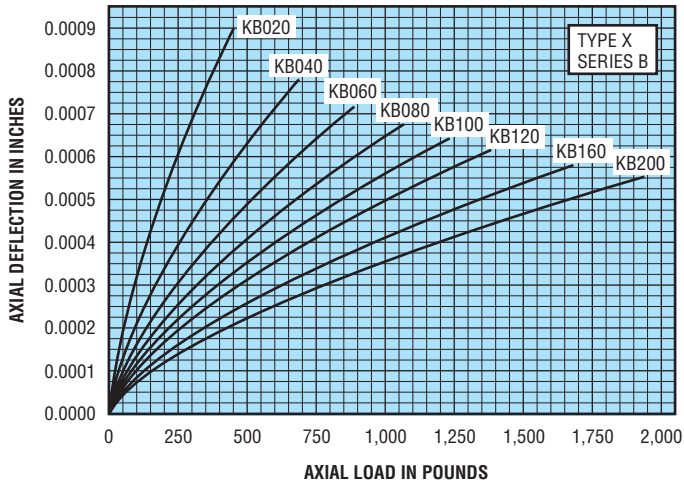

Figure 4-39

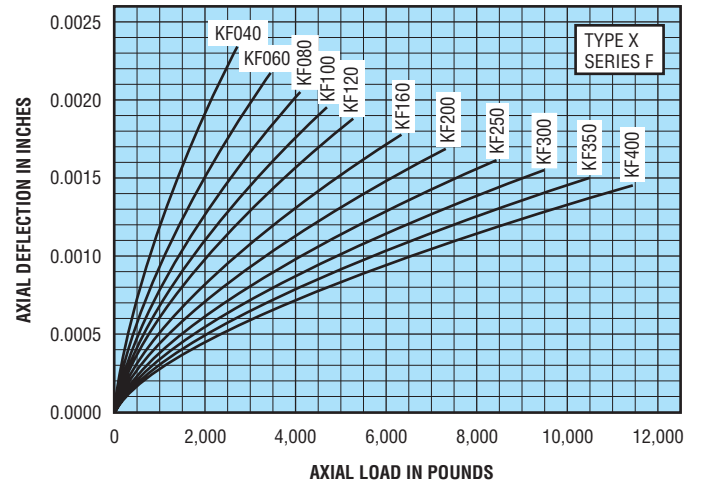

Figure 4-37

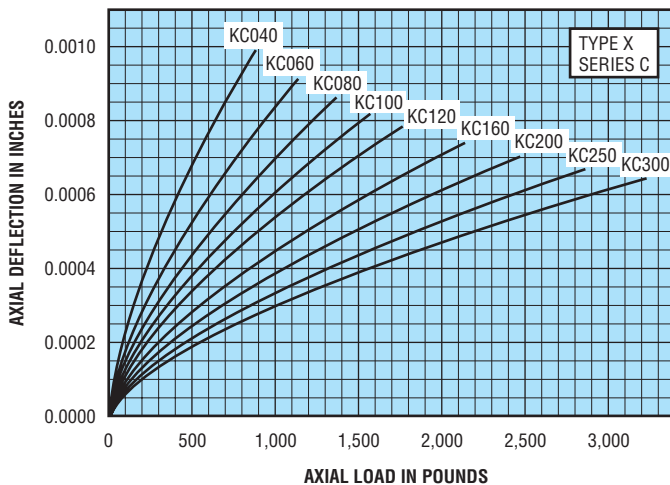
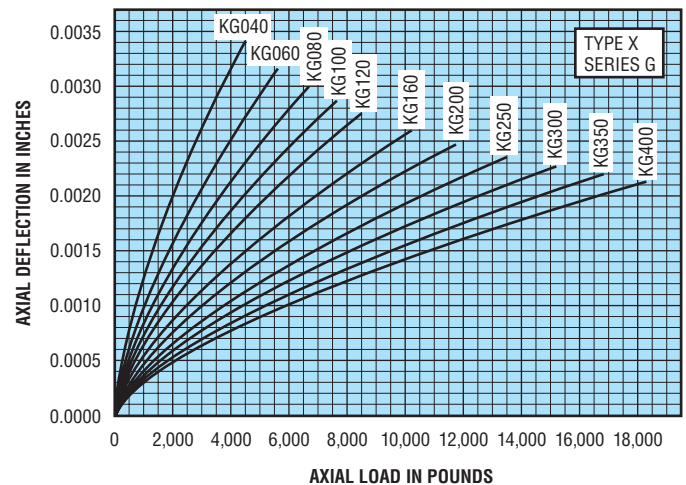

Figure 4-40



Radial Deflection vs. Radial Load

Type X Four-Point Contact

For more detailed information, use KAYDON REALI-DESIGN™ software

Figure 4-41

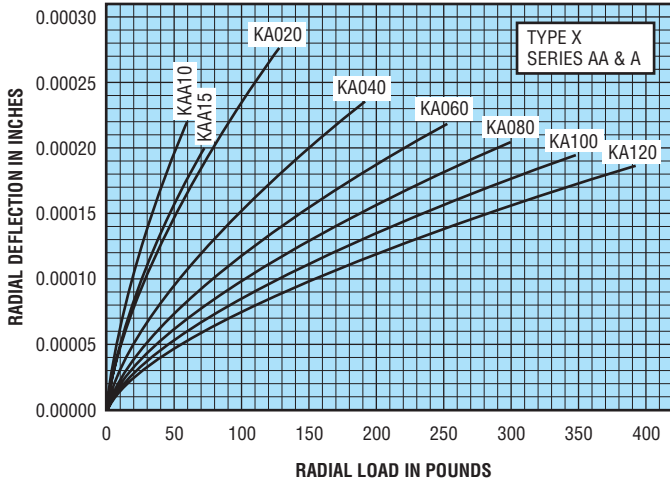

Figure 4-44

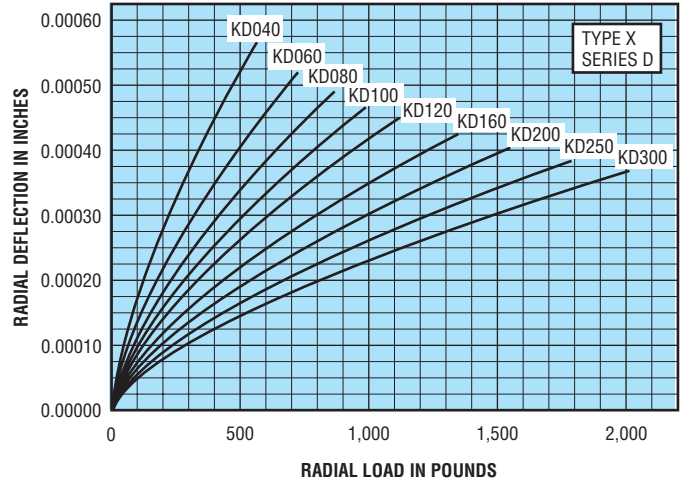

Figure 4-42

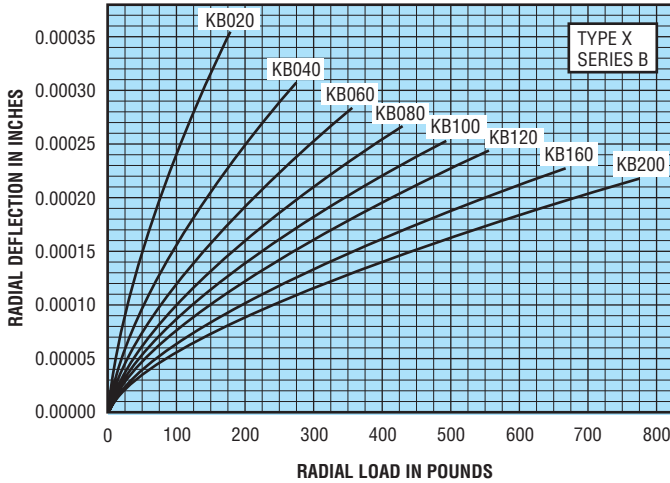

Figure 4-45

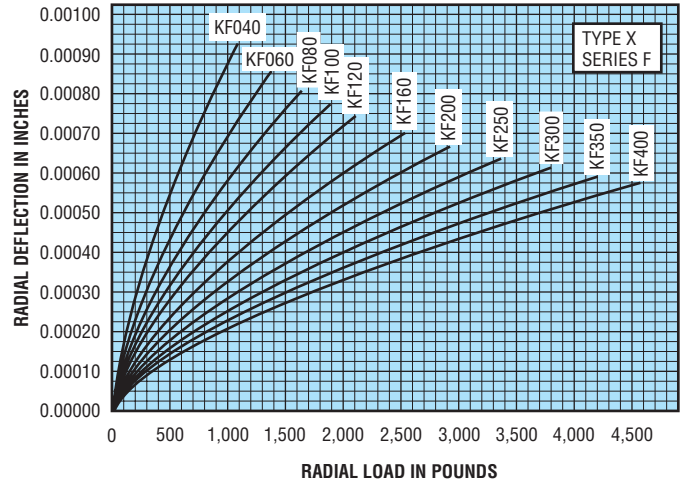

Figure 4-43

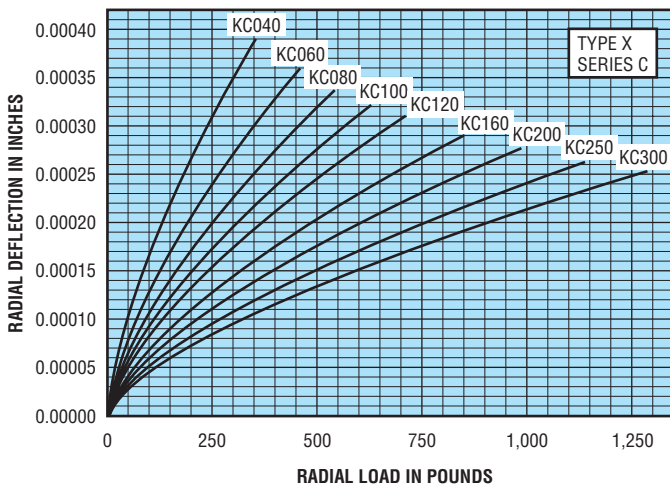
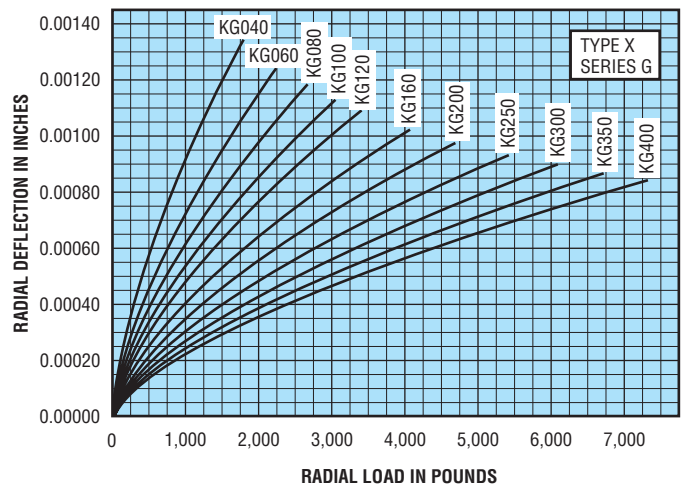

Figure 4-46



Moment Deflection vs. Moment Load

Type X Four-Point Contact

For more detailed information, use KAYDON REALI-DESIGN™ software

Figure 4-47

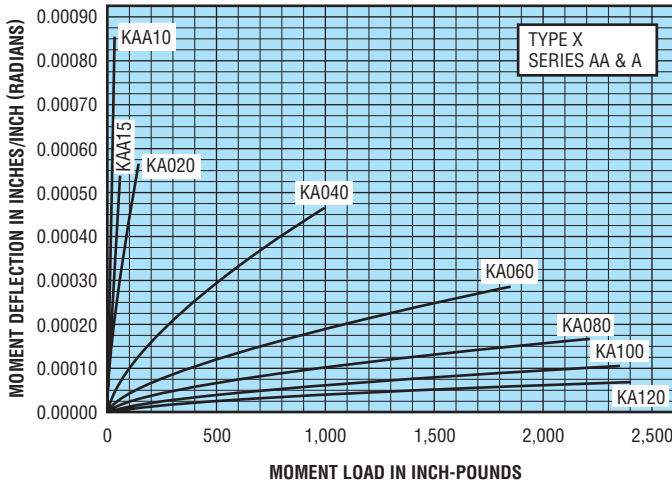

Figure 4-50

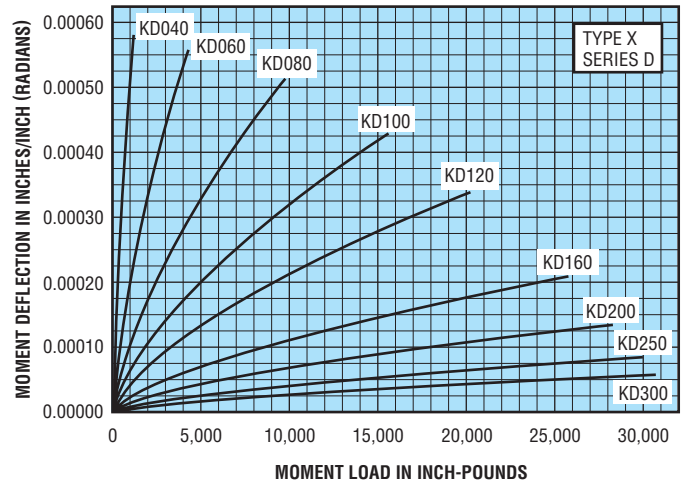

Figure 4-48

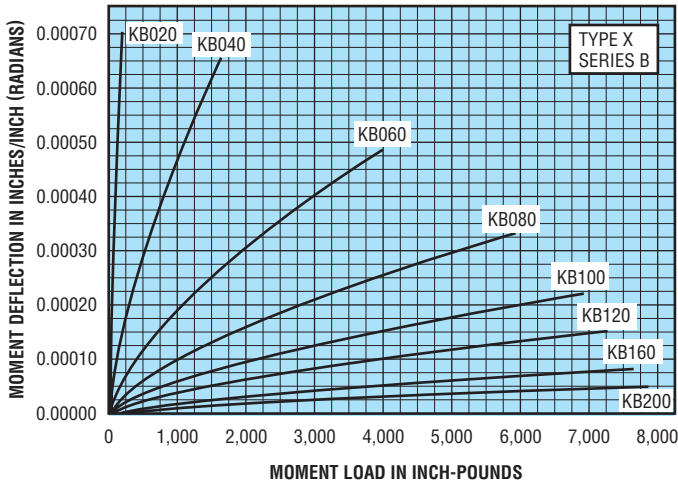

Figure 4-51

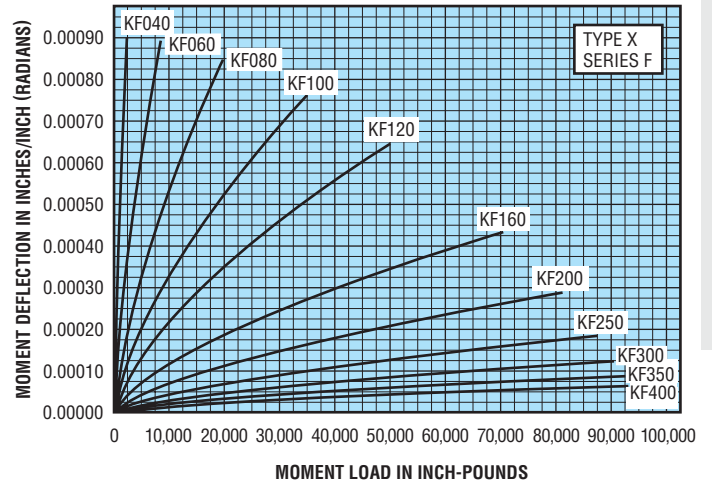

Figure 4-49

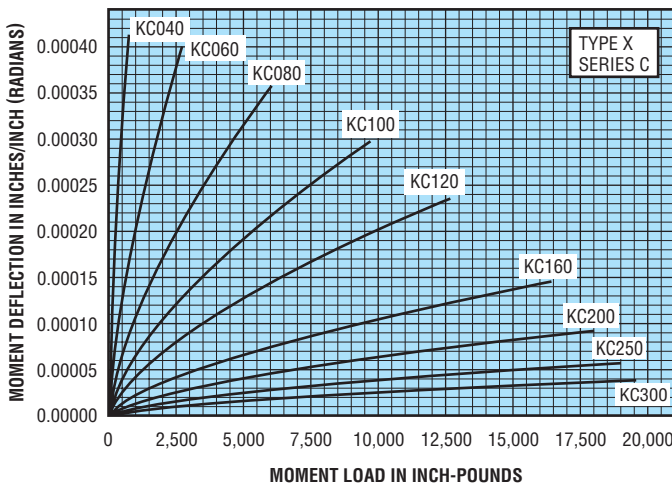
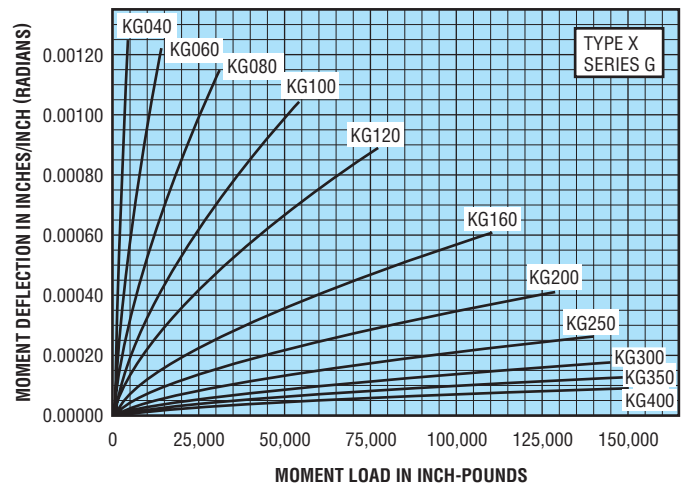

Figure 4-52



Section 5 — Installation and Maintenance of REALI-SLIM® Thin-Section Bearings



	Page Number
• Inspection and Installation Procedures	111
• Lubrication and Maintenance	113

Inspection and Installation Procedures for REALI-SLIM® Thin-Section Bearings

Inspection

The unique proportions of REALI-SLIM® bearings make some of the usual gaging practices impractical. Since very light pressure is sufficient to deflect the thin rings, conventional two-point measurement of bearing bore and outside diameter must not be used. Air gages of the open jet type, or other proximity devices, must be used to hold error from distortion to an acceptable level. Measurements must be made at enough points to yield a true average size, which may not be the mean of the maximum and minimum measurement. A REALI-SLIM® bearing may be out-of-round in the free state^① more than the ABMA tolerance for its precision class. This presents no problem since the races will conform readily to a round shaft diameter and housing bore.

To determine the true runout of each race, by excluding the effect of out of roundness, measurement is made of variation in individual wall thickness. This is schematically illustrated in Figure 5-1. The indicator must contact the raceway at the ball or roller contact, and must be properly positioned for the particular runout (axial or radial) being checked.

Measurement of Radial Runout of Type C Inner Race

Figure 5-1

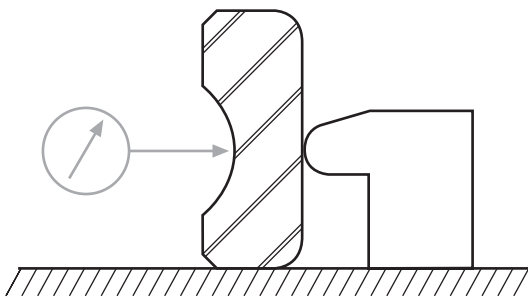

^① As explained in ABMA Standard 26.2

Diametral clearance of REALI-SLIM® bearings is controlled by selective assembly of races and balls following measurement with gages specially designed for this purpose.

Standard inspection and quality control procedures at KAYDON meet the requirements of government procurement agencies and major aerospace industries. However, a certificate of compliance to specifications can be furnished if required.

Installation

To realize the potential accuracy and long life of a REALI-SLIM® bearing, it is important that the installation be properly done in a clean environment. Cleanliness is vital to satisfactory bearing performance. Work surfaces and tools must be free of dirt, chips, and burrs. Disposable wipers or clean, lint-free cloths should be used.

Under no circumstances should a bearing be used as a gage during grinding or machining of mating parts. Just a few grains of grinding grit or chips of metal (soft as well as hard) can seriously damage the precise geometry and finishes of bearing raceways and rolling elements, and are nearly impossible to remove from an assembled bearing.

The shaft and housing should be thoroughly cleaned, special attention being given to holes and crevices which could hold dirt, chips, and cutting oil. Unfinished surfaces of castings should be painted or otherwise sealed. The mounting surfaces for the bearing must be carefully checked, cleaned, and lightly oiled to ease fitting and minimize danger of scoring. Housing bore, shaft diameter, shoulder squareness, and fillet sizes should all be verified.

The bearing should not be removed from its protective package until this preparation is complete and it is time for installation.

INSPECTION AND INSTALLATION PROCEDURES FOR REALI-SLIM® THIN-SECTION BEARINGS (continued)

Interference fitting any bearing to the shaft or housing must be carefully done to avoid damage to the bearing. For REALI-SLIM® bearings, the use of temperature difference to expand the outer member is recommended to minimize or eliminate the installation force necessary. To calculate the differential required, use a coefficient of expansion of .000007 inch per inch per degree F for AISI 52100 steel races and .0000056 for AISI 440C races. For a KAYDON Precision Class 1 bearing of 2" bore to be fitted to a steel shaft, the differential required to eliminate all interference between a maximum diameter shaft and minimum diameter bearing is 90°F; for a 4" bore it is 60°F. Either dry heat or hot oil may be used. Electrical resistance tape is convenient for the large bearings. Care must be taken to avoid overheating the bearing. Do not exceed 250°F.

If pressure is necessary, an arbor press should be used with a suitable pusher to apply the force to the full face of the ring being press fitted — never through the bearing, as damage will be done to the balls and raceways.

All duplexed bearings are marked with a single "V" on the bores and outside diameters to indicate the proper relative circumferential position of inner and outer races. This "V" is located at the high points of race eccentricity so that these may be placed at the low points of shaft and housing eccentricity for the canceling effect.

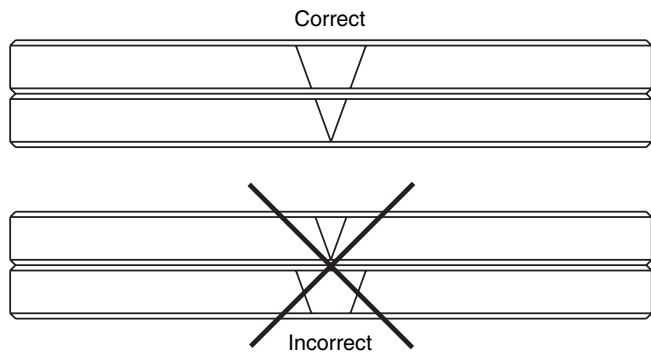

After mounting, the bearings must be given continued protection from contamination until the assembly is closed. Adherence to these procedures will assure a successful installation.

If it is necessary to return a bearing to KAYDON, it should be coated with protective oil and wrapped the same as when shipped from the factory to prevent damage during transit. If bearings are being returned after use for a failure analysis, they should be returned in the as removed condition, since the condition of the part (cleanliness, lubricated condition, etc.) will provide important data for failure analysis.

CONTACT KAYDON AT—

KAYDON Corporation • Muskegon, Michigan 49443
Telephone: 231/755-3741 • Fax: 231/759-4102

NEED SERVICE FAST?

1-800-514-3066

Website: www.kaydonbearings.com

Lubrication and Maintenance of REALI-SLIM® Thin-Section Bearings

The lubricant in an anti-friction bearing serves to reduce friction and wear between moving parts, to dissipate heat, and to prevent corrosion of critical surfaces. KAYDON recommends the selection of the proper lubricant be based on an evaluation by the system design engineer of the operating conditions, including at a minimum: rotational speed, type and magnitude of loads, and ambient temperature.

The three types of lubricant commonly used are oil, grease, and dry film or surface treatment.

Oil normally provides more complete lubrication. Because of its liquid state, it provides better coverage of the critical surfaces and assists in dissipating heat more readily, the latter being especially true when circulation and cooling are provided. In high-speed applications where the heating effect is more pronounced, oil is specified (see page 99). Where minimum torque is a requirement, oil will usually provide lower friction values.

Grease offers certain advantages of its own. Because it is more easily retained, the design of bearing housings and seals is simplified. In many applications, the lubricant itself serves to exclude contaminants when used in conjunction with labyrinths or close clearances between the rotating and stationary structures. For the higher speeds within the range suitable for grease lubrication, a channeling type of grease is often selected.

Dry films and surface treatments have been used as bearing lubricants in applications subject to environmental extremes, particularly where

conventional lubricants cannot be tolerated or will not survive. A wide variety of types are available for selection; options include Tungsten disulfide, graphite, and Molybdenum disulfide.

It is important to note that the quantity of lubricant affects bearing performance under certain operating conditions. Only relatively small amounts of lubricant are necessary to reduce friction and wear if a film can be maintained on all contacting surfaces. Where speed is significant, excessive amounts of oil or grease will result in higher operating temperatures, leading to the possibility of early bearing fatigue.

Unsealed bearings are supplied with a coating of preservative-type lubricating oil for the prevention of corrosion during storage. KAYDON recommends that this preservative be removed with clean petroleum solvent prior to lubrication. If the lubricant is not removed, the compatibility of the lubricant with the preservative oil must be confirmed.

In applications where minimum torque is required, the coating should be removed by washing with a clean petroleum solvent followed by immediate relubrication with an oil selected for the application. An option is to have REALI-SLIM® bearings factory lubricated with a commercial grease or oil selected by the customer in order to facilitate installation.

Sealed bearings are packed approximately one-third full with a multi-purpose industrial grease. Exterior surfaces are given a light coating of the same lubricant for protection during storage in the original package.

LUBRICATION AND MAINTENANCE OF REALI-SLIM® THIN-SECTION BEARINGS (continued)

Bearings, with or without seals, can be supplied with optional lubricants. Shown in the accompanying table are some of the greases and oils more frequently specified. Several have been developed to meet the requirements of unusual operating conditions. **Because of this and the variation in cost, it is recommended that lubricants be selected with the assistance of a lubrication expert.**

Due to the finite shelf life of any wet lubricant, factory lubricated bearings should not be held more than two years prior to use. Contact KAYDON for refurbishment

instructions for product held beyond two years of receipt.

To realize the full potential of a REALI-SLIM® bearing, KAYDON recommends that the customer’s maintenance instructions and schedules consider the operating conditions and include procedures to assure the bearings are adequately protected against the intrusion of foreign matter of all types, and fresh oil or grease introduced with sufficient frequency to cleanse the bearing and assure adequate lubrication.

Figure 5-2

Lubrication Temperature Ranges

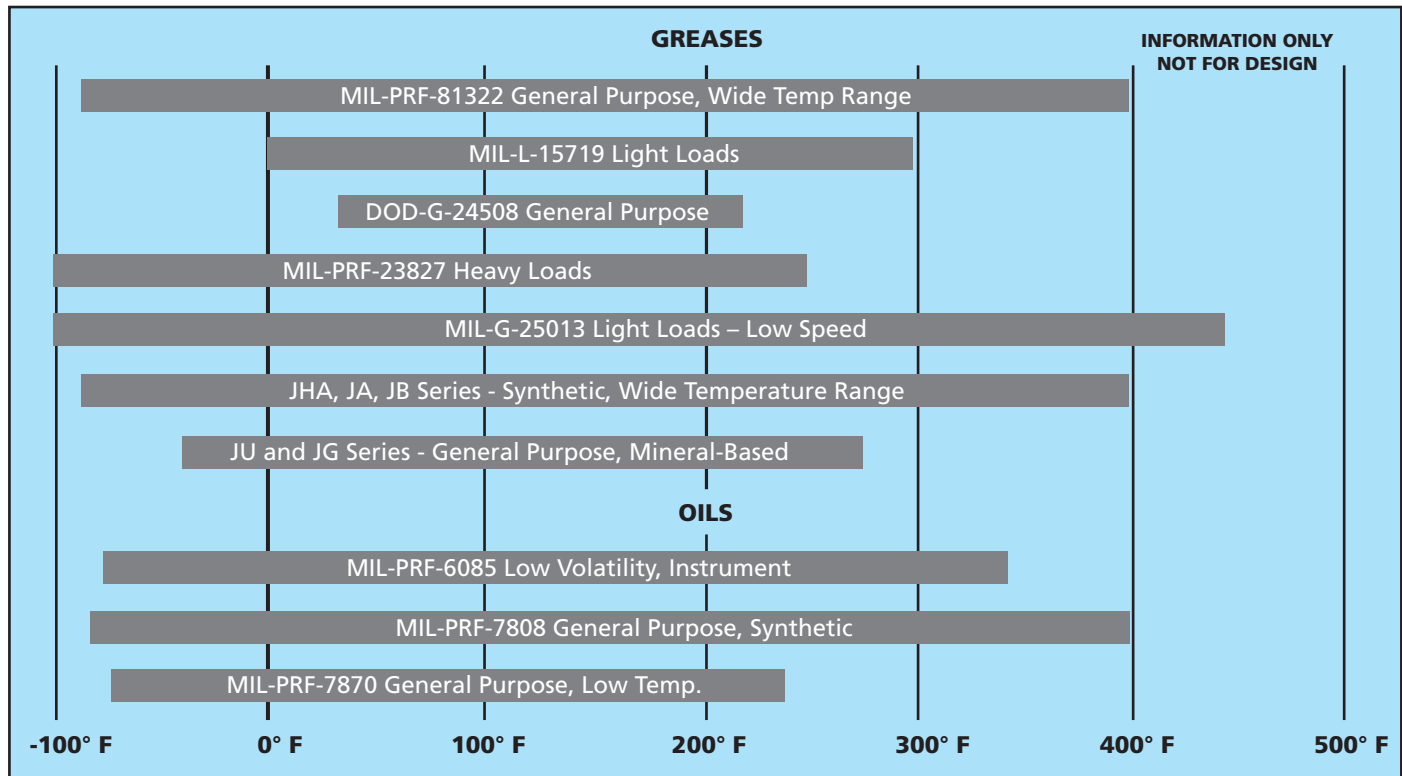

Section 5—Installation & Maintenance

Section 6 — Other Products



	Page Number
• Metric Series Ball Bearings - BB Series.....	116
• Bearings for Demanding Applications	119
• KT Series Tapered Roller Bearings.....	121

Metric Series Ball Bearings (BB Series)

Drop-in Replacements For Cross-Roller Bearings



KAYDON BB Metric Series four-point contact ball bearings are dimensionally interchangeable with cross-roller bearings.

BB Series Bearings Are Available to Match the Bores and Widths of Common Cross-Roller Bearings.

When factors such as cost, availability, corrosion resistance, tighter tolerances, torque, seal/shield options, and temperature resistance are important in your application, it pays to consider BB Series four-point contact metric ball bearings as an alternative to cross-roller bearings. The additional design flexibility they offer can often help you achieve your design objectives with optimum performance and economy.

Additional features not commonly available in standard cross-roller bearings include a protective package for corrosion resistance, custom sealing for extreme environments, application-specific lubrication and temperature capability.

Optimize Your Design Options

With additional features not commonly available in standard cross-roller bearings, BB Series bearings provide greater design flexibility.

ENDURAKOTE® plating—For applications requiring superior corrosion resistance we offer our proprietary ENDURAKOTE® plating. This thin, dense chrome plating gives AISI 52100 bearing material corrosion resistance equal to or better than that of AISI 440C stainless steel. Unlike many traditional chrome platings, the extremely hard surface of ENDURAKOTE® plating doesn't peel and flake from the bearing race under stress, so corrosion resistance is retained and surface wear is minimized. The performance of ENDURAKOTE® plating has been proven in critical military, aerospace, and deep space applications.

Seals/Shields—Standard industry seals are generally available from nitrile rubber. KAYDON can also provide custom seals manufactured from silicone or Viton® materials for applications where high temperature or extreme environments are likely to be encountered.

Temperature Capability—Standard cross-roller bearings have a maximum full capacity operating temperature of only 212°F. In contrast, KAYDON bearings can operate at higher temperatures due to our heat treating procedures.

Lubrication Options—KAYDON offers a full range of lubricants, allowing you to optimize bearing performance in a range of applications with special requirements for moisture resistance, hot or cold temperatures, vacuum, and low torque.

Separators—The common roller spacer for many cross-roller bearings is a non-metallic composite. High temperature and/or horizontal axis applications, however, require non-standard materials or a non-standard separator design. KAYDON four-point contact ball bearings are available with separator options to meet a wide range of applications.

Internal Fitup—KAYDON can help you optimize internal fitup of our BB Series four-point contact ball bearings to provide the desired operating performance. Pre-loaded bearings are recommended for greater stiffness, and diametral clearance is recommended for lower torque applications.

METRIC SERIES BALL BEARINGS - BB SERIES (continued)

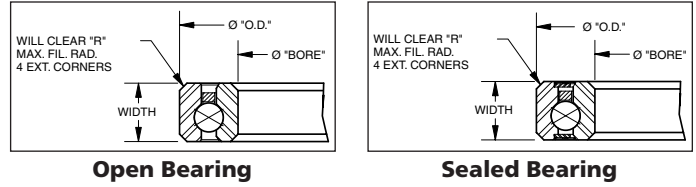

All dimensions in mm

(REALI-SLIM® replacements for RB Series standard cross-roller bearings)

Model Number	KAYDON Part No.	Approx. Weight (kg)	Bore (nominal +0)	O.D. (nominal +0)	Width (nominal +0)	"R"	Dynamic Capacity		
							Radial (kg)	Axial (kg)	Moment (N-m)
BB3010	39318001	0.1	30 -0.01	55 -0.013	10 -0.12	1	497	675	78
BB3510	39319001	0.11	35 -0.012	60 -0.013	10 -0.12	1	513	709	90
BB4010	39320001	0.12	40 -0.012	65 -0.013	10 -0.12	1	553	776	107
BB4510	39321001	0.13	45 -0.012	70 -0.013	10 -0.12	1	591	839	125
BB5013	39322001	0.24	50 -0.012	80 -0.013	13 -0.12	1	948	1321	227
BB6013	39323001	0.3	60 -0.015	90 -0.013	13 -0.12	1	1010	1436	279
BB7013	39324001	0.31	70 -0.015	100 -0.015	13 -0.12	1	1108	1601	346
BB8016	39325001	0.62	80 -0.015	120 -0.015	16 -0.12	1	1679	2417	618
BB9016	39326001	0.73	90 -0.02	130 -0.015	16 -0.12	1.5	1773	2584	718
BB10020	39327001	1.21	100 -0.02	150 -0.015	20 -0.12	1.5	2395	3480	1102
BB11015	39328001	0.66	110 -0.02	145 -0.018	15 -0.12	1	1390	2097	652
BB11020	39329001	1.36	110 -0.02	160 -0.02	20 -0.12	1.5	2524	3720	1300
BB12025	39330001	2.13	120 -0.02	180 -0.02	25 -0.12	2	3981	5745	2197
BB13025	39331001	2.27	130 -0.025	190 -0.025	25 -0.12	2	4098	5968	2412
BB14025	39332001	2.5	140 -0.025	200 -0.025	25 -0.12	2	4359	6402	2726
BB15013	39333001	0.61	150 -0.025	180 -0.025	13 -0.12	1	1590	2455	965
BB15025	39334001	2.72	150 -0.025	210 -0.025	25 -0.12	2	4468	6614	2959
BB15030	39335001	4.54	150 -0.025	230 -0.025	30 -0.12	2	6403	9325	4475
BB20025	39336001	3.4	200 -0.03	260 -0.03	25 -0.12	2.5	5121	7820	4333
BB20030	39337001	5.72	200 -0.03	280 -0.03	30 -0.12	2.5	7288	10980	6435
BB20035	39338001	8.17	200 -0.03	295 -0.03	35 -0.12	2.5	9367	13921	8529
BB25025	39339001	4.09	250 -0.03	310 -0.035	25 -0.12	3	5718	8939	5891
BB25030	39340001	7.04	250 -0.03	330 -0.035	30 -0.12	3	8100	12519	8641
BB25040	39341001	9.08	250 -0.03	355 -0.035	40 -0.12	3	10324	15812	11489
BB30025	39342001	4.99	300 -0.035	360 -0.035	25 -0.12	3	6163	9821	7482
BB30035	39343001	11.8	300 -0.035	395 -0.035	35 -0.12	3	11263	17595	14399
BB30040	39344001	15.44	300 -0.035	405 -0.035	40 -0.12	3	11240	17595	14576
BB40035	39345001	12.03	400 -0.04	480 -0.04	35 -0.25	3.5	12701	20518	20560
BB40040	39346001	20.66	400 -0.04	510 -0.04	40 -0.25	3.5	12888	20919	21572
BB50040	39347001	22.7	500 -0.045	600 -0.045	40 -0.25	3.5	14381	23996	29099
BB50050	39348001	38.05	500 -0.045	625 -0.045	50 -0.25	3.5	14555	24367	30120
BB60040	39349001	27.24	600 -0.045	700 -0.045	40 -0.2	4	15709	26887	37565
BB70045	39350001	44.95	700 -0.045	815 -0.045	45 -0.25	4	16887	29634	47062
BB80070	39351001	98.52	800 -0.05	950 -0.05	70 -0.25	5	26846	47799	86420
BB90070	39352001	109.87	900 -0.05	1050 -0.05	70 -0.25	5	28307	51478	101535

Note 1: Capacities listed are not simultaneous. For combined loading see discussion of Bearing Selection and Load Analysis. Dynamic capacities are based upon 1 million revolutions of L10 life. Published capacities do not apply to hybrid series bearings P, X, and Y - contact KAYDON product engineering for values.

Note 2: Standard bearings are supplied without seals and shields, and they are assembled with a light clearance. Alternate features can be obtained by adding the following suffix letter to the basic part number.

- U = single seal CO = standard clearance CCO = preload TT = double shield
- UU = double seal CI = greater than standard clearance T = single shield Check for availability.

METRIC SERIES BALL BEARINGS - BB SERIES (continued)

All dimensions in mm

Model Number	Bore (nominal +0)	O.D. (nominal +0)	Width (nominal +0)	Standard Diametral Clearance	Radial and Axial Runout	
					Inner	Outer
BB3010	30 -0.01	55 -0.013	10 -0.12	0.025-0.038	0.01	0.01
BB3510	35 -0.012	60 -0.013	10 -0.12	0.03-0.043	0.01	0.01
BB4010	40 -0.012	65 -0.013	10 -0.12	0.03-0.043	0.013	0.013
BB4510	45 -0.012	70 -0.013	10 -0.12	0.03-0.043	0.013	0.013
BB5013	50 -0.012	80 -0.013	13 -0.12	0.03-0.056	0.013	0.013
BB6013	60 -0.015	90 -0.013	13 -0.12	0.03-0.056	0.013	0.013
BB7013	70 -0.015	100 -0.015	13 -0.12	0.03-0.056	0.015	0.015
BB8016	80 -0.015	120 -0.015	16 -0.12	0.03-0.056	0.015	0.015
BB9016	90 -0.02	130 -0.015	16 -0.12	0.041-0.066	0.015	0.015
BB10020	100 -0.02	150 -0.015	20 -0.12	0.041-0.066	0.015	0.015
BB11015	110 -0.02	145 -0.018	15 -0.12	0.041-0.066	0.015	0.02
BB11020	110 -0.02	160 -0.02	20 -0.012	0.041-0.066	0.015	0.02
BB12025	120 -0.02	180 -0.02	25 -0.12	0.05-0.08	0.02	0.02
BB13025	130 -0.025	190 -0.025	25 -0.12	0.05-0.08	0.025	0.025
BB14025	140 -0.025	200 -0.025	25 -0.12	0.05-0.08	0.025	0.025
BB15013	150 -0.025	180 -0.025	13 0.23	0.05-0.08	0.025	0.025
BB15025	150 -0.025	210 -0.025	25 -0.12	0.05-0.08	0.025	0.025
BB15030	150 -0.025	230 -0.025	30 -0.12	0.05-0.08	0.025	0.025
BB20025	200 -0.03	260 -0.03	25 -0.12	0.06-0.09	0.03	0.03
BB20030	200 -0.03	280 -0.03	30 -0.12	0.06-0.09	0.03	0.03
BB20035	200 -0.03	295 -0.03	35 -0.12	0.06-0.09	0.03	0.03
BB25025	250 -0.03	310 -0.035	25 -0.12	0.07-0.1	0.035	0.035
BB25030	250 -0.03	330 -0.035	30 -0.12	0.07-0.1	0.035	0.035
BB25040	250 -0.03	355 -0.035	40 0.12	0.07-0.1	0.035	0.035
BB30025	300 -0.035	360 -0.035	25 -0.12	0.07-0.1	0.035	0.035
BB30035	300 -0.035	395 -0.035	35 -0.12	0.07-0.1	0.035	0.035
BB30040	300 -0.035	405 -0.035	40 -0.12	0.07-0.1	0.035	0.035
BB40035	400 -0.04	480 -0.04	35 -0.25	0.08-0.11	0.04	0.04
BB40040	400 -0.04	510 -0.04	40 -0.2	0.08-0.11	0.04	0.04
BB50040	500 -0.045	600 -0.045	40 -0.25	0.09-0.12	0.045	0.045
BB50050	500 -0.045	625 -0.045	50 -0.25	0.09-0.12	0.045	0.045
BB60040	600 -0.045	700 -0.045	40 -0.25	0.09-0.12	0.045	0.045
BB70045	700 -0.045	815 -0.045	45 -0.25	0.09-0.12	0.045	0.045
BB80070	800 -0.05	950 -0.05	70 -0.25	0.09-0.12	0.05	0.05
BB90070	900 -0.05	1050 -0.05	70 -0.25	0.1-0.13	0.05	0.05

Section 6—Other Products

CONTACT KAYDON AT—
 KAYDON Corporation • Muskegon, Michigan 49443
 Telephone: 231/755-3741 • Fax: 231/759-4102

NEED SERVICE FAST?
1-800-514-3066
 Website: www.kaydonbearings.com

Bearings for Demanding Applications

(Material Codes S, P, X, and Y)

KAYDON stainless steel bearings are used where high precision and corrosion resistance are required.

REALI-SLIM® thin-section bearings are available in AISI 440C stainless steel races, brass or non-metallic separators, and your choice of either stainless steel or ceramic balls. Offered in either radial contact "C," angular contact "A," or four-point contact "X" configurations. These bearings, available in popular sizes, minimize the surface degradation and particulate formation so common in harsh environment applications. (See pages 49-52.)

Hybrid bearings are very well suited for applications where lubrication is marginal.

KAYDON REALI-SLIM® thin-section bearing product line has been expanded to include several additional bearing series specifically engineered to bring the advantages of REALI-SLIM® bearings to designs intended for service in the most severe or extreme environments. We offer REALI-SLIM® bearings with a variety of packaged features to meet specific operation requirements for:

- Chemical resistance/high temperature—P Series (See next page.)
- High performance/low torque—Q Series
- High performance/low particle—X, Y Series

Applications requiring low particle generation, high accuracy, high speeds, and/or which must operate in adverse or no-lube conditions, can benefit from hybrid bearings. Tests have shown that significant reductions in particle generation can be obtained with hybrid designs which incorporate the use of ceramic rolling elements on hardened steel races. In addition, the physical properties of the ceramic rolling elements (precision, hardness, light weight) provide additional benefits such as improved repeatability, low torque, high stiffness, and resistance to breakdown under marginal or no-lube conditions.

Tremendous benefits in performance can be obtained by matching not just size but also material to the application. These alternative race and ball materials interact differently than traditional chrome steel bearings. Capacities, life calculations and stiffness will differ from other products in this catalog. Contact KAYDON for technical characteristics of hybrid REALI-SLIM® bearings.

BEARINGS FOR DEMANDING APPLICATIONS (continued)

Series P—Chemical Resistant

In applications where both corrosion resistance and chemical resistance are required, series P bearings may be required. These bearings feature AISI 17-4PH steel races and ceramic balls. They're manufactured to provide a greater level of corrosion and chemical resistance than either KAYDON Series N or Series S bearings. Due to the hardening limitations of AISI 17-4PH steel, an adjustment factor of .17 must be applied to the standard dynamic capacity ratings. Thus, the use of P Series bearings should be carefully reviewed prior to selection to determine if the life and capacity are adequate.

Materials

Races	AISI 17-4PH steel
Balls	Borosilicate, glass, or ceramic
Cage	Type A; PTFE or Vespel® toroid ball spacers or 300 series steel ring
	Types C & X; Stainless steel or non-metallic composite ring

Specifications for Hybrid REALI-SLIM® Bearings

ITEM	DESCRIPTION	REFERENCE SPECIFICATION
	MATERIAL ANALYSIS	
RACES	AISI 440C Stainless steel	ASTM A-756
BALLS	AISI 440C Stainless steel or ceramic: Silicon Nitride	
SEPARATORS C, X BEARINGS A BEARINGS	P Type—Brass or non-metallic composite L Type—Nylon, fiberglass reinforced R Type—Brass or non-metallic composite G Type—Nylon, fiberglass reinforced	ASTM B-36 or B-134 ASTM B-36 or B-134
	PRECISION	
RACE DIMENSIONS	KAYDON Precision Class 1, Higher classes available	ABMA ABEC-1F or better
RACE RUNOUTS	KAYDON Precision Class 1, Higher classes available	ABMA ABEC-1F or better
BALLS	ABMA Grade 10 Stainless steel or Grade 5 ceramic	ANSI/ABMA/ISO 3290

} other options, see p. 93

KT Series Tapered Roller Bearings



The KAYDON concept of standard bearings with light weight, thin sections, and large bore diameters includes tapered and radial roller bearings as well as ball bearings.

KT Series tapered roller bearings offer advantages to those designs

requiring a bearing of higher capacity, which would benefit from the many unique advantages of a thin-section bearing. KT tapered roller bearings are used to advantage in applications ranging from oil field equipment to machine tool tables where space and weight considerations are meaningful.

KT Series standard tapered roller bearings have races and rollers of through-hardened AISI 52100 steel with a one-piece stamped steel cage. When specified, they

can be furnished in pairs match ground for use with or without spacers.

The tapered roller bearings in this catalog are of the single-row radial type, designed primarily for application of radial load. While of separable construction, the rolling elements are retained in the separator.

Since this bearing assumes a contact angle of approximately 12° under an axial force, it does have a reasonable amount of thrust capacity. This capacity is uni-directional and is realized when the axial force is applied to the wide faces of the races.

As in the case of the angular contact ball bearing, the single row tapered roller bearing is commonly mounted in opposition to another bearing (usually of similar construction) to provide an axial force for establishing and maintaining the angle of contact. Two bearings of this type maybe mounted with the lines of contact converging outside of the bearings (back-to-back) or inside (face-to-face) with the former preferred for stability in the presence of overturning load.

KAYDON Bearing Number	Bore d (IN)	Outside Dia. D (IN)	Assem. Width T (IN)	Factor K (IN)	Rating at 500 RPM for 3000 hrs. L-10		Cone Width B (IN)	Cup Width C (IN)	Shoulder Diameters				Approx. Bearing Wt. (LB)
					Radial (LB)	Thrust (LB)			Shaft		Housing		
									S1 (IN)	S2 (IN)	H1 (IN)	H2 (IN)	
KT-070	7.000	8.500	.812	1.74	4970	2860	.812	.625	7.375	7.300	8.125	8.250	3.11
KT-091	9.125	10.250	.718	1.79	4920	2750	.722	.597	9.625	9.312	9.850	10.050	2.88
• KT-098	9.875	11.500	1.062	1.85	9260	5000	1.062	.875	10.375	10.225	11.063	11.250	6.05
KT-100	10.000	11.125	.625	1.79	4020	2250	.625	.500	10.500	10.300	10.750	10.900	2.88
KT-110	11.000	12.500	.875	1.86	7620	4100	.875	.688	11.438	11.250	12.000	12.250	5.06
KT-112	11.250	12.750	.812	1.86	7150	3860	.812	.625	11.688	11.500	12.313	12.500	4.72
KT-118	11.875	13.562	.937	1.76	7250	4120	.812	1.125	12.438	12.210	13.000	13.320	6.63
KT-130	13.000	14.562	.843	1.44	5580	3880	.843	.594	13.438	13.320	14.125	14.300	5.20
KT-132	13.250	15.000	.937	1.69	6160	3650	.937	.750	13.875	13.625	14.375	14.500	6.79
KT-151	15.125	17.375	1.125	1.72	11760	6840	1.125	.812	15.750	15.625	16.750	16.875	13.57
KT-165	16.500	18.750	.875	1.78	8220	4620	.882	.812	17.250	17.000	18.125	18.500	11.14
KT-180	18.000	19.625	.812	1.69	7400	4330	.812	.687	18.438	18.375	19.188	19.300	8.19
KT-200	20.000	21.750	.812	1.80	7930	4400	.812	.687	20.625	20.375	21.125	21.250	9.78

• Available from Stock—check for availability of other sizes.
 Tolerances are: Bore: +.001" – .000" up to KT-110; +.002" – .000" for KT-110 to KT-200
 Outside Diameter: Same as for bore.
 Width: ±.010" up to KT-112; ±.015" for KT-112 to KT-200
 Cup Radial Runout .0015" Max. F.I.M., Cone Radial Runout .0020" Max. F.I.M.

Section 6—Other Products

Section 7 — Appendix and Sales Information

	Page Number
• Terms and Definitions	123
• Warranty Information and Legal Notices	124
- Disclaimer	
- Hazard Notice	
- Terms and Conditions of Sale - Warranty	
- Responsibility Statement and Registered Trademarks	
• Engineering Design Aids and Technical Literature	127
• Request for Bearing Proposal Data Form	129
• Conversion Factors	131

Bearing Definitions and Terms

Axial Clearance:

The total amount of free axial movement between the inner and outer race of a bearing. Bearings with internal clearance will contain both axial and radial clearance.

Axial Load:

Load applied to the bearing parallel with the bearing axis of rotation — also known as thrust load.

Capacity:

Dynamic capacity is the basic “C” rating which represents a load that the bearing can theoretically endure for 1 million revolutions. Static capacity is the approximate load the bearing can endure before permanent deformation occurs on the ball or raceway. Published capacities do not apply to hybrid series bearings P, X, and Y. Contact KAYDON product engineering.

Deflection:

The amount of movement associated with compression or stretching of bearing components when placed under load.

Diameter Tolerance:

The range in which the average diameter of a bore or O.D. may fall. REALI-SLIM® bearings are considered “non-rigid” rings and all diameters are averaged using multi-point gaging techniques per ABMA Std. 26.2.

Diametral Clearance:

The total free movement of the inner race relative to the outer race in a radial plane, also referred to as radial clearance. “X” and “C” type bearings are made with some internal clearance as a standard factory internal fit before mounting.

L₁₀ Life:

The theoretical life span of a bearing under a specific set of dynamic operating conditions associated with 90% reliability.

Moment Load:

Load such that when applied to a bearing system, tends to overturn or bend the axis of rotation in an angular direction.

Pitch Diameter:

The theoretical median diameter of a bearing, which passes through the center of the rolling elements. REALI-SLIM® pitch diameters are equivalent to: $(OD+Bore)/2$.

Preload:

The amount of load placed on the rolling elements before the application of any external loads. Preload can be created in “X” and “C” type bearings by controlling internal fits of the ball and the raceway at the factory. Preload in angular contact bearings is controlled by a “preload gap” between the duplexed races. Tight mounting conditions will increase the final bearing preload. Preload stiffens the bearing and eliminates axial and radial play, but the load on the balls increases friction and shortens L₁₀ life.

Radial Load:

Load applied perpendicular to the bearing axis of rotation.

Runout:

The maximum axial or radial race wall thickness variation of an inner or outer bearing race. Runout influences the repeatable location variation of rotating components.

Standard bearing nomenclature

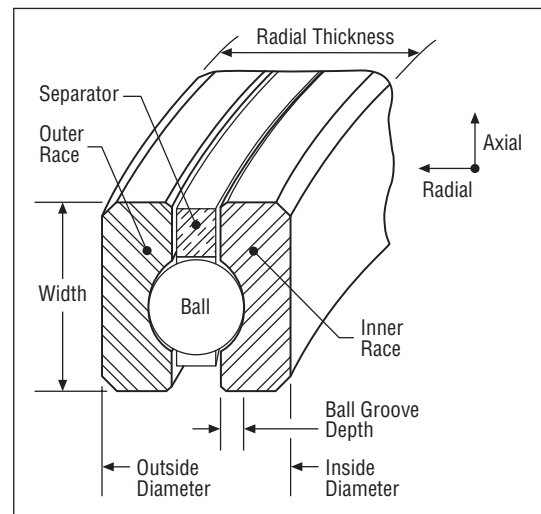

Warranty Information and Legal Notices

Disclaimer

The design and application information contained in this catalog is for illustration only. Responsibility for the application of the products contained in this catalog rests solely with the equipment designer or user. In spite of our best efforts, the material contained in this catalog may contain inaccuracies and typographical errors.

Hazard Notice

The use of any part, such as those described in this catalog, may be hazardous and have the potential to cause serious injury, including death, to people or property. The purchaser is responsible for evaluating the hazards associated with any part used in their application.

KAYDON Standard Terms and Conditions of Sale

- 1) Scope.** Prices quoted are for acceptance within thirty (30) days from date of quotation unless otherwise stated. The terms and conditions of sale set forth below apply to all quotations made and purchase orders accepted by Seller.
 - 2) Acceptance of Orders.** All orders are subject to acceptance by authorized officials at Seller's division or subsidiary offices. All sales are made in accordance with these terms and conditions of sale. Any other document containing additional or different terms and conditions, or any attempt to vary these terms and conditions, shall be deemed a material alteration or modification hereof and all sales are made without such additional or different terms and conditions.
 - 3) Scheduling.** Shipping dates are approximate and are based upon prompt receipt of all necessary information. Buyer shall furnish to Seller written shipping instructions in sufficient time to permit Seller to make shipment at Seller's option within any time or times herein specified for shipment. In the event of a delay in delivery due to any reason described in Section 16 below, the delivery date shall be deferred for a period equal to the time lost by reason of delay. In the event such delay shall continue for more than two weeks, then, at Seller's option, the order will be deemed cancelled without liability to Seller.
 - 4) Quantities.** Seller reserves the right to ship quantities (or weight, as applicable) that are within ten percent (10%) of the quantity (or weight) specified by Buyer, and Seller shall not be liable for any overshipment or undershipment within this limit. In the event of any overshipment within this limit, Buyer shall pay for the actual quantity (or weight) shipped.
 - 5) Delivery and Transportation.** Seller's delivery dates are approximate. Seller shall not be liable for delays in delivery or other defaults in performance of this order arising out of causes beyond Seller's control. Unless otherwise agreed to in writing by Seller, delivery of the products hereunder shall be made F.O.B. at the point of shipment with delivery to the initial carrier to constitute delivery to the Buyer. Title to products passes to Buyer and products are at risks to Buyer from and after delivery to the initial carrier. Transportation expenses will be paid by Buyer and risk of loss, shortage, delay or damage to products in transit shall fall upon Buyer, whose responsibility it shall be to file claims with the carrier.
 - 6) Terms of Payment.** Invoices are due and payable (30) thirty days from the date of invoice unless other terms are shown on the face hereof. A 1-1/2% (one-and-a-half percent) carrying charge will be applied to all past due amounts. If shipments are delayed by Buyer, payments shall become due on the date when Seller is prepared to make shipment. If the work covered by the purchase order is delayed by Buyer, payments shall be made based on the purchase price and the percentage of completion. Seller reserves the right to ship to its order and make collection by sight draft with bill of lading attached.
 - 7) Taxes.** Prices do not include foreign or domestic sales, use, excise or similar taxes. Consequently, in addition to the prices specified herein, the amount of any present or future sales, use, excise or other general or specific tax, or imports, duties or penalties or other governmental charges fixed or imposed by any lawful authority(s) upon or applicable to the production, sale, shipment, delivery or use of the products sold hereunder shall be added to the price and be paid by Buyer or, in lieu thereof, Buyer shall provide Seller with a tax exemption certificate acceptable to the taxing authorities. If such tax is paid by Seller, Buyer shall reimburse Seller upon presentation of invoice.
 - 8) Warranty.** Seller warrants the products manufactured by it to be free from defects in material and workmanship only. The extent of Seller's obligation hereunder is to either repair or replace its work or the defective products, F.O.B. Seller's plant, if returned within twelve (12) months after date of delivery. No allowance will be granted for repairs or alterations made by Buyer without Seller's written approval. The warranty shall not be construed to cover the cost of any work done by Buyer on material furnished by Seller or the cost of removal or installation of product. Products and parts not manufactured by Seller are warranted only to the extent and in the manner that the same are warranted to Seller by Seller's vendors and then only to the extent Seller is able to enforce such warranty. There is no other warranty, expressed or implied, in fact or by law.

THE FOREGOING STATES THE SOLE AND EXCLUSIVE WARRANTY OF BUYER AND THE SOLE AND EXCLUSIVE WARRANTY OF SELLER. THE WARRANTIES STATED IN THIS PARAGRAPH ARE IN LIEU OF ALL OTHER WARRANTIES WRITTEN OR VERBAL, STATUTORY, EXPRESSED OR IMPLIED, INCLUDING WARRANTIES OF MERCHANTABILITY AND FITNESS FOR A PARTICULAR PURPOSE, WHICH ARE HEREBY DISCLAIMED.
- Seller's agreement to sell the products is made upon the condition and agreement that, with respect to the products, there have been no representations or undertakings made by or on behalf of Seller and Seller makes no guarantees or warranties, expressed or implied, in fact or in law, except as expressly stated above.
- 9) Limitation of Liability.** Seller shall not be responsible, obligated, or liable for any injury or damage resulting from an application or use of its products, either singly or in combination with other products. SELLER'S SOLE LIABILITY FOR BREACH OF WARRANTY OR ANY OTHER CLAIM SHALL BE LIMITED TO REPAIR OR REPLACEMENT OF THE PRODUCTS OR RETURN OF THE PURCHASE PRICE, AT SELLER'S SOLE OPTION. SELLER SHALL NOT BE LIABLE FOR DAMAGES, INCLUDING BUT NOT LIMITED TO CONSEQUENTIAL OR SPECIAL DAMAGES ARISING OUT OF OR IN CONNECTION WITH THE USE OR PERFORMANCE OF THE PRODUCTS OR ARISING OUT OF ACCEPTANCE OF THIS ORDER.
 - 10) Acceptance of Products.** Products will be deemed accepted without any claim by Buyer unless written notice of non-acceptance is received by Seller within thirty (30) days of delivery if shipped F.O.B. point of shipment, or ten (10) days of delivery if shipped F.O.B. point of destination. Such written notice shall not be considered received by Seller unless it is accompanied by all freight bills for such shipment, with agent's notations as to damages, shortages and conditions of equipment, containers and seals. Non-accepted products are subject to return policy stated below.

WARRANTY INFORMATION AND LEGAL NOTICES (continued)

11) Return of Products. No product may be returned to Seller without Seller's prior written permission, which permission may be withheld by Seller in its sole discretion.

12) Damages to Returned Products. If Buyer elects to return product(s) to Seller for refurbishment, Buyer agrees to accept all risk of damage or destruction of such returned product(s), and Seller shall not be liable for any failure or inability on the part of Seller to complete refurbishment upon any such returned products.

13) Limitations of Actions. Irrespective of whether Seller agreed to perform field start-up or any other service after the delivery of the product, all claims or actions must be brought within one (1) year of date of tender of delivery, or eighteen (18) months of Buyer's order, if no tender of delivery is made, notwithstanding any statutory period of limitation to the contrary.

14) Patents. Buyer shall hold Seller harmless against any expense or loss resulting from infringement of patents or trademarks arising from compliance with Buyer's design, specifications or instructions.

The sale of products or parts thereof by Seller does not convey any license by implication, estoppel, or otherwise under patent claims covering combinations of these products or parts with other devices or elements.

15) Financial Responsibility. If in the sole judgment of Seller the financial resources of Buyer become impaired or unsatisfactory at any time during the term of the agreement between the parties, then Seller may require of Buyer a deposit or suitable security or margin for performance by Buyer in such amount or amounts from time to time as Seller shall specify. Upon requirement of deposit, Buyer shall make such deposit not later than the close of Seller's next business day. If Buyer fails to make such deposit, then Seller may at its option (1) cancel the agreement between the parties or the undelivered portion thereof, in which case Buyer agrees to pay Seller the difference between the market price on date of cancellation and the contract price; (2) resell at any time for Buyer's account all or any undelivered portion of the products, in which case Buyer agrees to pay Seller the difference between the resale price and the contract price, or (3) otherwise change the terms of payment. In the event Buyer shall be or becomes insolvent, or admits in writing Buyer's inability to pay Buyer's debts as they mature, or if Buyer shall make an assignment with creditors or if there are instituted by or against Buyer proceedings in bankruptcy or under any insolvency laws or for reorganization, receivership or dissolution, Seller may terminate the agreement between the parties at any time and without notice.

16) Force Majeure. In the event of war, fire, epidemics, quarantine restrictions, flood, strike, labor trouble, breakage of equipment, accident, riot, the imposition of any governmental price control regulation or any other act of governmental authority, acts of God or other contingencies (whether similar or dissimilar to the foregoing) beyond the reasonable control of Seller, interfering with the production, supply, transportation, or consumption practice of Seller at the time respecting the products covered by the agreement between the parties or in the event of inability to obtain on terms deemed by Seller to be practicable any raw material (including energy source) used in connection therewith, quantities so affected shall be eliminated from the contract without liability, but the contract shall otherwise remain unaffected. Seller may during any period of shortage due to any of these causes, allocate its supply of such raw material among its various uses therefore (e.g. manufacturing and sales) in such manner as Seller deems practicable and

allocate its supply of such products among such various uses thereof in any manner which Seller deems fair and reasonable.

17) Reasonable Attorneys' Fees. In the event suit or other proceeding shall be brought for the recovery of the purchase price, or any unpaid balance or the breach by Buyer of any term of the agreement between Seller and Buyer, Buyer shall pay to Seller, in addition to any damages provided by law, reasonable attorneys' fees and costs of collection.

18) Security Title. Security title and right of possession of the products sold hereunder shall remain with Seller until all payments due from Buyer to Seller (including deferred payments whether evidenced by notes or otherwise) shall have been made in cash and Buyer agrees to do all acts necessary to perfect and maintain such security right and title in Seller.

19) Cancellations. Buyer may cancel an order only upon written consent and upon payment to Seller of cancellation charges, which shall take into account among other things expenses incurred and commitments already made by Seller, and Seller's profit margin.

20) General

(a) The agreement between Buyer and Seller and matters connected with the performance thereof shall be construed in accordance with and governed by the law of the State of Seller's accepting offices, as referenced in Section 2, as though it were executed and performed entirely within the State of Seller's accepting offices, as referenced in Section 2, and shall be construed to be between merchants.

(b) Any assignment of the agreement between Buyer and Seller or any rights or obligation of the agreement by Buyer without written consent of Seller shall be void.

(c) Except as may be expressly provided to the contrary in writing, the provisions of the agreement between Buyer and Seller are for the benefit of the parties hereto and not for any other person.

(d) No waiver by Seller of any breach of any provision of the agreement between Buyer and Seller will constitute a waiver of any other breach.

(e) The terms and conditions set forth above contain all the representations, stipulations, warranties, agreements and understandings with respect to the subject matter of the agreement between Buyer and Seller, and its execution has not been induced by any representation, stipulation, warranty, agreement or understanding (including any course of prior dealings between the parties hereto) of any kind other than those set forth above.

(f) No amendment, addition to, alteration, modification or waiver of all or part of the agreement between Buyer and Seller shall be of any force or effect unless in writing and signed by Seller. If the terms and conditions set forth above conflict with those of any purchase order of Buyer written in connection with the sale of the products or any portion thereof, then the terms set forth above shall govern.

21) Arbitration. Any controversy or claim arising out of or relating to the agreement between Buyer and Seller, or the breach thereof, shall be settled in the City and State of the Seller's accepting offices, as referenced in Section 2, by arbitration in accordance with the Rules of the American Arbitration Association, and judgment upon the award rendered by the arbitrator may be entered in any court having jurisdiction thereof.

“RESPONSIBILITY STATEMENT”

WARNING

FAILURE OF, OR IMPROPER SELECTION OF, OR IMPROPER USE OF THE PRODUCTS DESCRIBED HEREIN OR RELATED ITEMS CAN CAUSE DEATH, PERSONAL INJURY AND PROPERTY DAMAGE.

This document and other information from Kaydon Corporation, its subsidiaries and authorized distributors provide product or system options for further investigation by users having technical expertise. Before you select or use any product or system, it is important that you analyze all aspects of your application and review the information concerning the product in the current product catalog. The user, through its own analysis and testing, is solely responsible for making the final selection of the product or system and assuring that all performance, safety and warning requirements of the application are met. The products and systems described herein, including without limitation, product features, specifications, designs, availability and pricing, are subject to change by Kaydon Corporation and its subsidiaries at any time without notice.

The following are registered trademarks of Kaydon Corporation: ENDURAKOTE®, ENDURA-SLIM®, LAMI-SEAL®, LAMI-SHIELD®, REALI-DESIGN®, REALI-DESIGN MM®, REALI-SLIM®, REALI-SLIM TT®, REALI-SLIM MM™, ULTRA-SLIM®.

**Visit our website:
www.kaydonbearings.com**

**for latest releases — newest features — and
downloads of catalogs,
software, or CAD drawings.**



Click on
**Catalogs &
Brochures**

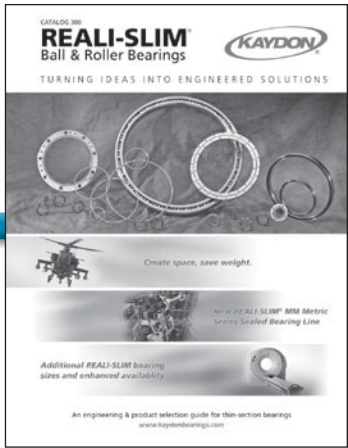

Click on
**Engineering
Software**



**REALI-DESIGN® and REALI-DESIGN MM®
Engineering Aids for REALI-SLIM®
Thin-Section Bearings**

- Save hours of tedious computations.
- Reduce bearing selection time to seconds.
- Accurately compute essential life and load analyses.
- Determine safe operating speeds.
- Calculate load deflections.

The REALI-DESIGN® program group is not simply a catalog on disk. This innovative software is an actual engineering aid designed to apply the calculating power of the computer to your complex power transmission design computations. Use this as a supplement to KAYDON Catalog 300 to select the exact REALI-SLIM® thin section bearing for your application.

Application Information to Help In Your Designs

All available for download from our website www.kaydonbearings.com.



1. REALI-SLIM® thin-section bearings catalog

Complete engineering and selection information on the entire product line, including REALI-SLIM MM™ metric series, REALI-SLIM TT® turntable series, and ULTRA-SLIM® series. 132 pages. Request **Catalog 300**.



2. An illustrated mounting guide for REALI-SLIM® bearings

Gives ideas on how to improve designs through better mounting and use of bearing assemblies. 24 pages. **Catalog 306 downloadable from website.**



3. REALI-DESIGN® and REALI-DESIGN MM® software

Speeds REALI-SLIM® bearing selection process. Includes data sheets, life calculations, and CAD-ready DXF library for both inch and metric series. Software downloadable from www.kaydonbearings.com.

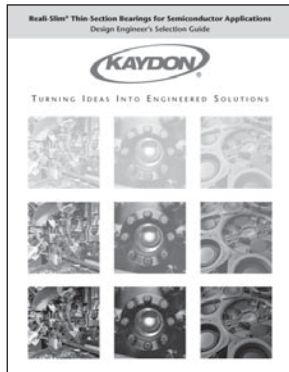

4. A design engineer's selection guide for REALI-SLIM® bearings in semiconductor applications

Engineering recommendations for use of KAYDON bearings in semiconductor manufacturing equipment. 8 pages. Download **Catalog 315 from website.**

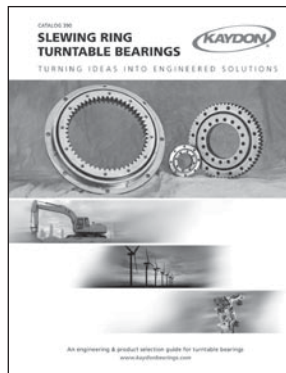

5. Slewing ring/turntable bearing catalog

Complete engineering and selection information on standard and custom turntable bearings up to 240". 132 pages. Request **Catalog 390**.

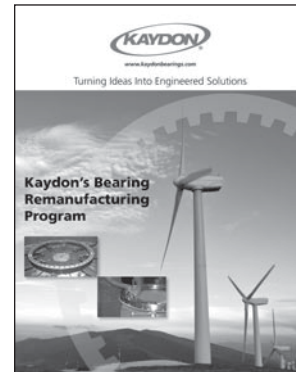

6. Kaydon's Bearing Remanufacturing Program brochure

Overview of ISO-certified repair services provided by Kaydon to remanufacture 10" to 240" diameter bearings to like-new quality and warranty, any OEM. 6 pages. Request Reman brochure or download from website.

Request For Bearing Proposal Data Form

Detach and fax completed form or complete and submit online at www.kaydonbearings.com.

Attention: KAYDON Sales

Date: _____

TO: KAYDON Corporation
Muskegon, Michigan 49443
Fax: 231-759-4102 Phone: 231-755-3741

FROM: _____

Project Description:

Application: _____
Type: _____
Annual Quantity: _____
Quotation Quantity: _____
Program Start Date: _____
Response from KAYDON Needed by: _____

For a preferred Size and Style of Bearing:

Preselected KAYDON Bearing Model #: _____

or

Bore: _____ inches O.D.: _____ inches Width: _____ inches

or

Envelope Size : _____ Min. Bore inches _____ Max. O.D. inches _____ Max. Width inches

For an L₁₀ life calculation: [Describe loads and/or mass on bearing]

Dynamic Radial avg.: _____ pounds
Dynamic Axial avg.: _____ pounds
Dynamic Moment avg.: _____ inch-lbs.
RPM (max) _____ RPM (min) _____ **or** Oscillation: Angle _____ Duty Cycle _____
Bearing axis is (vert/horiz) with the (inner/outer) race rotation relative to load
Minimum Hours needed: _____

For a Safety factor calculation: [describe any maximum shock or impact Loads]
[Note: Do not include Safety factor in these loading values !!!!]

Static Radial Max: _____ pounds
Static Axial Max: _____ pounds
Static Moment Max: _____ inch-lbs.

For determining Shaft and Housing sizes: [Attach proposed mounting sketch if possible]

	Material	Radial Thickness	Low Temperature	Normal Temperature	High Temperature
Shaft	_____	_____	_____	_____	_____
Housing	_____	_____	_____	_____	_____

For Accuracy concerns:

KAYDON Precision Class _____
or
Radial Runout _____ Axial Runout _____

For Stiffness or Deflection concerns:

Springrate: _____
or
Movement under load: _____

For Torque to Rotate concerns:

Maximum allowable Starting Torque: _____

For Other or Environmental Conditions:

Operating Temperature Range: _____
Vacuum Range: _____
Proposed Lubricant is : _____
Seals or Shields: _____
Protective Coating: _____

Mounting Sketch

**Fax Request for Bearing Proposal Data Form to:
(231) 759-4102**

Conversion Factors

	English-Metric	Metric-English
Length	1 in = 25.4 mm	1 mm = .03937 in
	1 ft = .3048 m	1 m = 3.281 ft
Force	1 lb = 4.448 N	1 N = 0.2248 lb
Torque/Moment	1 ft-lb = 1.356 N-m	1 N-m = .7376 ft-lb
	1 in-lb = .113 N-m	1 N-m = 8.851 in-lb
	1 in-oz = 72.01 gf-cm	1 gf-cm = .01389 in-oz
Weight	1 lb = .4536 kg	1 kg = 2.205 lb
	1 oz = 28.35 g	1 g = .03527 oz
Stress / Pressure	1 psi = 6895 Pa (N/m ²)	1 Pa = .000145 psi
	1 ksi = 6.895 MPa (N/mm ²)	1 MPa = .145 ksi
Temperature	(°F - 32) / 1.8 = °C	1.8 x °C + 32 = °F

(rounded to 4 significant digits)



KAYDON Corporation
2860 McCracken Street
Muskegon, Michigan 49441 U.S.A.
Phone: +1 (231) 755-3741
Fax: +1 (231) 759-4102

15K-10-04-01 Catalog 300

Need Service Fast?
1-800-514-3066

Visit our website: www.kaydonbearings.com