

For New Technology Network

NTN[®]

NTN corporation

Bearings for Special Environments

Ultra Final Series

CAT. No. 3023-III / E



NTN

Bearings for Special Environments

NTN responds to emerging market needs with unique technologies for extreme environments.

C O N T E N T S

1. Selecting Bearings for Extreme Environments	2
2. Classifications and Standard Specifications of Bearings for Special Environments	3 to 4
3. Performance and Technical Data of Various Bearings	5
3.1 Vacuum bearings	5
3.2 Bearings for clean environments	7
3.3 Bearings for corrosive environments	11
3.4 Electrically conductive bearings	11
4. Material Characteristics	11
5. Applications	12
6. Dimensions	13 to 17
6.1 Vacuum bearings	13
6.2 Ultra-clean bearings	14
6.3 Long life ultra-clean bearings	15
6.4 Bearings with low out particle grease	16
6.5 Bearings with low out particle grease for vacuum environment	17
Handling Precautions	18



Recent advances in the process technologies employed in semiconductor fabrication and other industrial sectors have raised expectations for the bearings used in vacuum environments. Today, such bearings are required to be cleaner, more durable and more resistant to corrosion. In response, NTN Corporation has developed a bearing technology that employs solid lubricant for ultra-high vacuum environments.

Moreover, NTN has continued to expand its product line with bearings designed for corrosive environments. These innovations round out a product line that already features vacuum bearings and ultra-clean bearings designed to accommodate today's increasingly complex production environments.

1. Selecting Bearings for Extreme Environments

The operating environments of today's advanced industries — as typified by the semiconductor fabrication industry — are complex and entail a variety of factors. To simplify the selection of the optimal bearings for complex environments, please refer to **Figure 1**. It illustrates schematically three such environments — vacuum, clean and corrosive — as well as the complex interrelation among these environments. This diagram lists the typical equipment and facilities found in each environment as well as the applicable bearings.

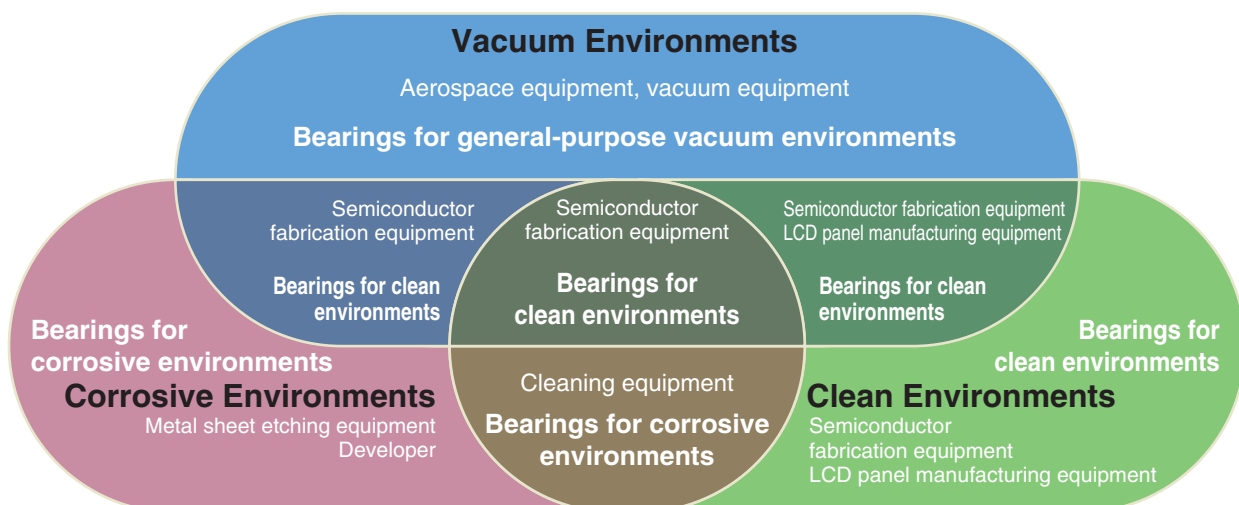

Fig. 1

2. Classifications and Standard Specifications of Bearings for Special Environments

Table 1 summarizes the standard specifications of bearings for special environments.
For custom specifications, please contact NTN Engineering.

Table 1. Bearings for Special Environments: Classifications and Standard Specifications

Classification	Operating Environment					Bearing Specification	
	Temperature	Atmosphere	Vacuum	Corrosives	Magnetic field	Inner Ring/Outer Ring	Ball
Vacuum environments	~150°C	○	○			Martensite stainless steel + MoS ₂ coating	Martensite stainless steel + MoS ₂ coating
	~300°C		○			Martensite stainless steel + Pb coating	Martensite stainless steel + Pb coating
	~400°C		○			Martensite stainless steel	Martensite stainless steel + Ag coating
Clean environments	~ 70°C	○				Martensite stainless steel	Martensite stainless steel
	~200°C	○	○				
	~260°C	○	○			Martensite stainless steel + special PTFE coating	Martensite stainless steel + special PTFE coating
	~300°C	○	○				Martensite stainless steel + special PTFE coating + special balls
Contaminant-free environments	~ 80°C	○				Bearing steel or martensite stainless steel	Bearing steel or martensite stainless steel
	~100°C	○					
	~120°C	○					
Corrosive environments	~120°C	○		○		Bearing steel + corrosion resistant coating	Bearing steel
		○		○		Martensite stainless steel	Martensite stainless steel
	~150°C	○	○	○	○	Ceramic	Ceramic
		○	○	○		Precipitation-hardened stainless steel	
		○		○	○	PPS resin	Ceramic or glass
High temperatures	~500°C	○				High-speed tool steel	Ceramic
	~800°C	○				Ceramic	
Cryogenic environments	-273°C~	○				Martensite stainless steel + special PTFE coating	Martensite stainless steel + special PTFE coating
Non-magnetic environments	~150°C	○			○	Non-magnetic steel	Ceramic
						Ceramic	
Anti-radioactivity	~120°C	○				Bearing steel	Bearing steel
Electrically conductive	~120°C	○				Bearing steel	Bearing steel
	~200°C	○				Heat-resistant treatment + bearing steel	
Electrically insulated	~120°C	○				Ceramic	Ceramic
		○				Bearing steel	
		○				Ceramic coating (outer ring)	Bearing steel
		○				PPS resin coating (outer ring)	

Bearing Specifications		Bearing No.	Technical Data Page Ref.
Cage	Grease		
PTFE resin	—	MM— . . . T3	P5, P6
Leaded copper alloy		MN— . . . L9	
Austenite stainless steel		5MG— . . .	
Austenite stainless steel	Low out particle grease	SSN. . . /L635QMP	P8, P9
	Low out particle grease in vacuum environments	SEB. . . /LX23Q..	P8
Austenite stainless steel + special PTFE coating	—	MT2—SEB. . .	P5, P7, P8, P9 P10
Austenite stainless steel + special PTFE coating		MT2—5PT—SEB. . .	P9
Cold rolled steel plate or austenite stainless steel	General-purpose with solid grease /LP03	
	Food-grade with solid grease /LP06	
	High-temperature with solid grease /LP05	
Cold rolled steel plate	Grease	MXn— . . .	
Austenite stainless steel		F— . . .	
PTFE resin or austenite stainless steel	—	S— . . .	
PTFE resin		5S—2Fn	
		5S—2N— . . .	P11
		2H—5S— . . .	
		S— . . .	
PTFE resin	—	MT2—F— . . . T3	
PTFE resin	Grease	5S—2Fn— . . .	
		S— . . .	
Cold rolled steel plate	Radioactivity-resistant grease		
Cold rolled steel plate	Electrically conductive grease (EP-2)	. . . /L646	P11
	Electrically conductive fluorine grease (EF-2)	TS3— . . . /LY06	
Cold rolled steel plate	Grease	S— . . .	
		5S— . . .	
		7MC— . . .	
		7MP— . . .	

3. Performance and Technical Data of Various Bearings

3.1 Vacuum bearings

Table 2 Performance of Vacuum Bearings

◎ : Excellent ○ : Good △ : Fair × : Not recommended

Bearing type	Allowable vacuum range Pa	Allowable temperature range °C	Load-carrying capacity	Low-torque performance	Out Particle	Outgassing	Electrical conductivity
MoS ₂ -coated bearings	10 ⁻⁵ ~1	~ +150	△	◎	○	○	×
Pb-coated bearings	~10 ⁻⁵	~ +300	○	◎	○	◎	○
Ag-coated bearings	~10 ⁻⁵	~ +400	△	○	○	◎	○
Bearings with vacuum grease (optional)	10 ⁻⁵ (vapor pressure) to atmospheric	~ +200	◎	×	×	×	×

Note: Ratings represent relative performance among vacuum bearings.

Test Data

Results of durability evaluation.

Figures 2 through 6 provide sample evaluations of coating-dependent durability.

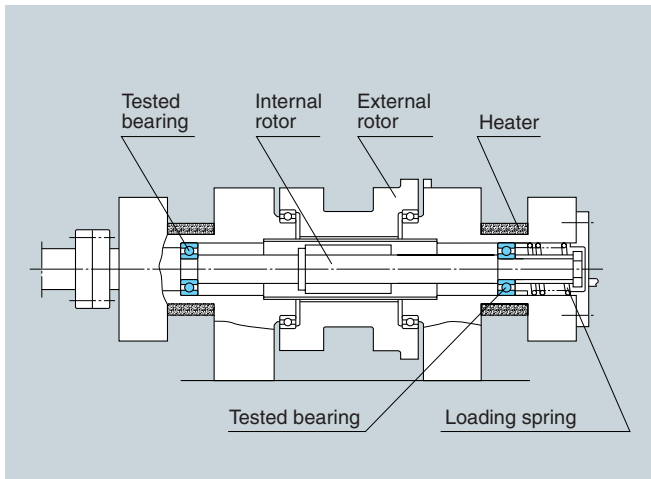

Fig. 2 Durability tester for high-vacuum bearing

● Test conditions

- Bearing : Deep groove ball bearings, φ8×φ22×7 (Open type)
- Axial load : 10N, 30N, 50N
- Speed : 2 500min⁻¹
- Degree of vacuum : Around 10⁻⁵ Pa
- Temperature : Room temperature
- Evaluation criterion : Bearing life is regarded as having expired when the bearing friction torque with two bearings reaches 10⁻² N · m.

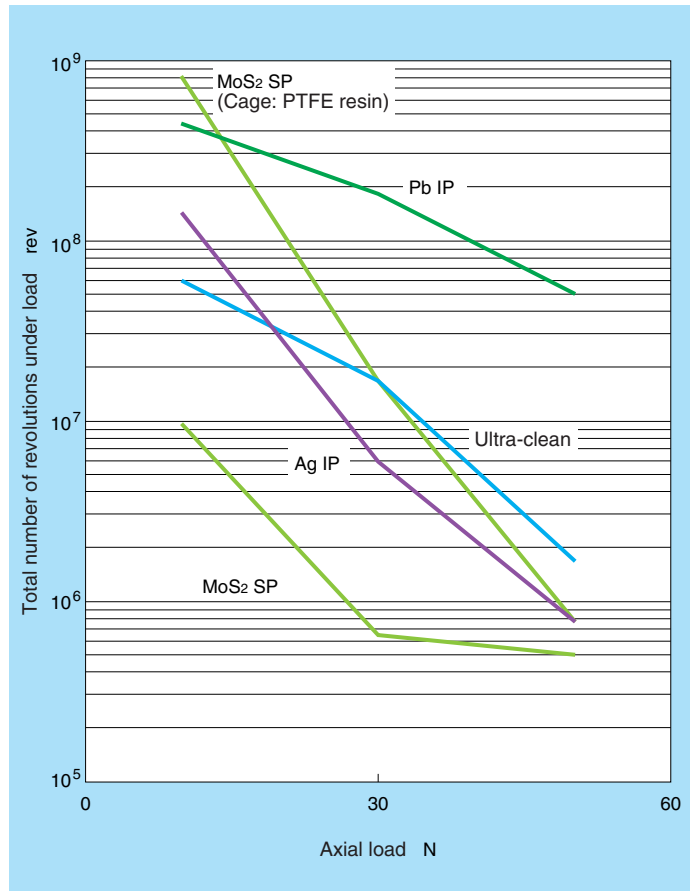

Fig. 3 Load vs. durability in a vacuum

● Test conditions

Bearing : Angular contact ball bearings, $\phi 10 \times \phi 22 \times 7$
 (Full complement type)
 Axial load : 10N
 Speed : $2\,500\text{min}^{-1}$
 Degree of vacuum : Around 10^{-5} Pa
 Temperature : Room temperature

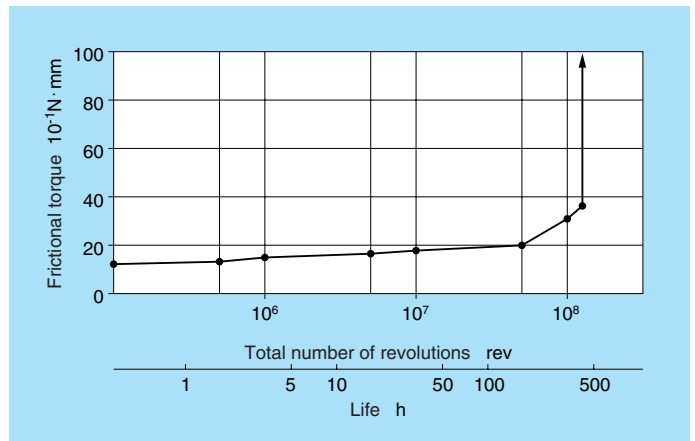

Fig. 4 Evaluation of durability of Ag IP bearing

● Test conditions

Bearing : Angular contact ball bearings, $\phi 10 \times \phi 22 \times 7$
 (Cage: Lead copper alloy)
 Axial load : 10N
 Speed : $7\,500\text{min}^{-1}$
 Degree of vacuum : Around 10^{-5} Pa
 Temperature : Room temperature

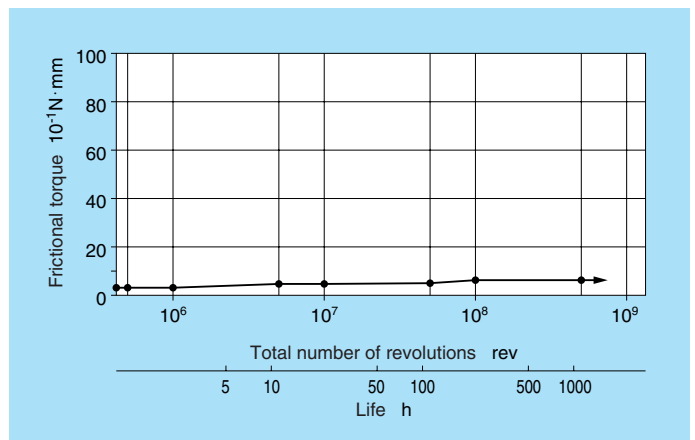

Fig. 5 Evaluation of durability of Pb IP bearing

● Test conditions

Bearing : Angular contact ball bearings, $\phi 10 \times \phi 22 \times 7$
 (Cage: PTFE resin)
 Axial load : 10N
 Speed : $7\,500\text{min}^{-1}$
 Degree of vacuum : Around 10^{-5} Pa
 Temperature : Room temperature

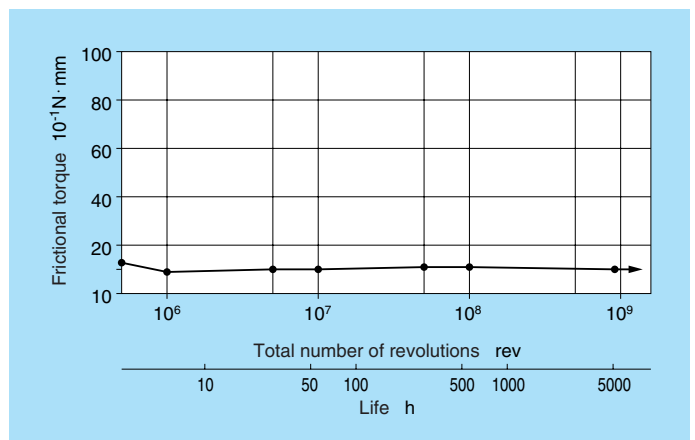

Fig. 6 Evaluation of durability of MoS₂ SP bearing

3.2 Bearings for clean environments

Table 3 Performance of Bearings for Clean Environments

◎ : Excellent ○ : Good △ : Fair × : Not recommended

Bearing type	Allowable vacuum range Pa	Allowable temperature range °C	Load-carrying capacity	Low-torque performance	Out Particle	Outgassing	Corrosion resistance	Maximum d_n value
Bearings with low out particle grease	Atmospheric	+ 70	◎	△	△	—1)	△	20×10^4
Bearings with low out particle grease for vacuum environment	10^{-5} to atmospheric	$\sim +200$	◎	×	△	△	△	20×10^4
Ultra-clean bearings	10^{-5} to atmospheric	$\sim +260$	△	◎	◎	◎	△	1×10^4
Long life ultra-clean bearings	10^{-6} to atmospheric	$\sim +300$	△	◎	○	◎	△	1×10^4

Note: Ratings represent relative performance among bearings designed for clean environments.

1) Excluded from evaluation because this type of bearing is used under atmospheric pressure.

Test Data

3.2.1 Evaluation of out particle characteristics

Figures 7 through 13 provide evaluations of the tendency to out particles.

● Test conditions

Bearing : Deep groove ball bearings
 $\phi 8 \times \phi 22 \times 7$
 Axial load : 10N
 Speed : 50 min^{-1}
 Minimum particle size measured : $0.3 \mu\text{m}$
 Temperature : Room temperature

● Test results

- Generation of airborne particles is indicated as the number of particles present in one cubic foot of collected air (number of particles/cf).
- NTN's ultra-clean bearings generate a very low particle count (equivalent to Class 10).

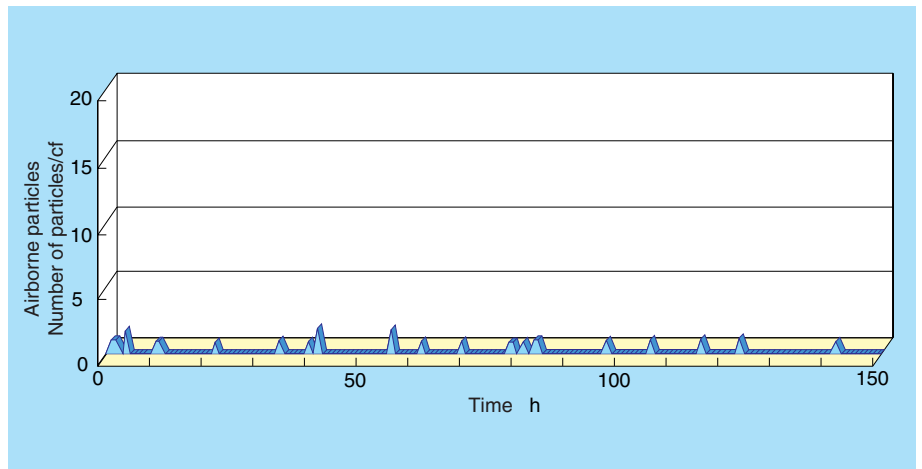

Fig. 7 Measurement of out particle by ultra-clean bearing (at atmospheric pressure)

● Test conditions

Bearing : Deep groove ball bearings
 $\phi 8 \times \phi 22 \times 7$
 Axial load : 10N (50N)
 Speed : 50 min^{-1}
 Degree of vacuum : Around 10^{-5} Pa
 Minimum particle size measured : $0.38 \mu\text{m}$
 Temperature : Room temperature (20°C)

● Test results

- The out particle characteristics of ultra-clean bearings are not significantly altered by load or temperature. This type of bearing exhibits low out particle over a wider range of conditions.

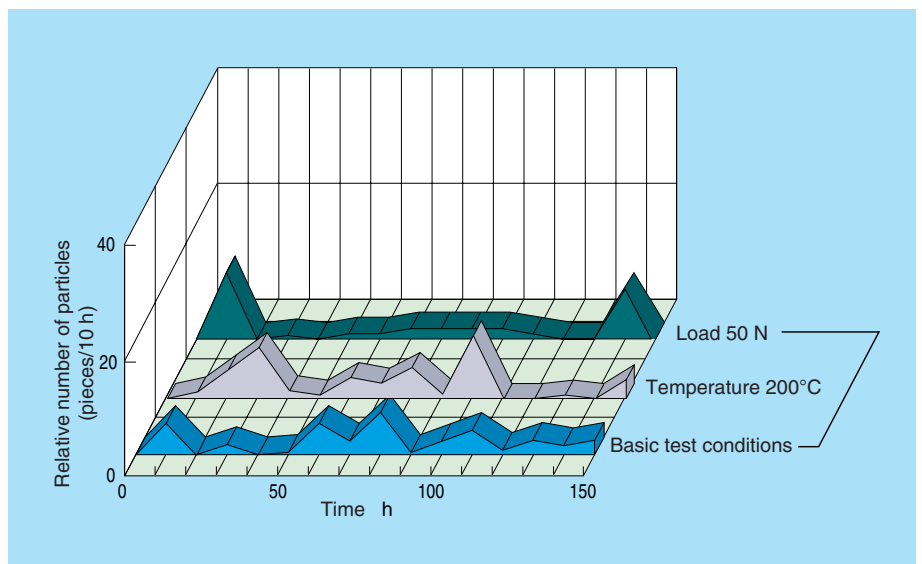

Fig. 8 Measurement of out particle by ultra-clean bearing (in vacuum)

● Test conditions

Bearing : Deep groove ball bearings $\phi 8 \times \phi 22 \times 7$
 Axial load : 10N
 Speed : 50min⁻¹
 Minimum particle size measured : 0.38 μm
 Degree of vacuum : Around 10⁻⁵ Pa

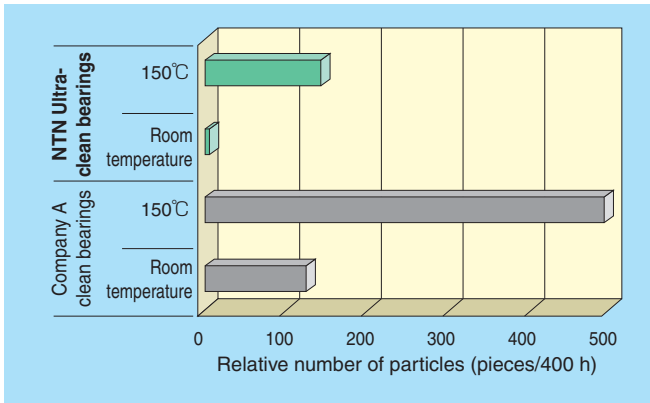

Fig. 9 Measurement of out particle by ultra-clean bearing (in vacuum)

● Test conditions

Bearing : Deep groove ball bearings $\phi 8 \times \phi 22 \times 7$
 Axial load : 10N
 Minimum particle size measured : 0.1 μm
 Temperature : Room temperature

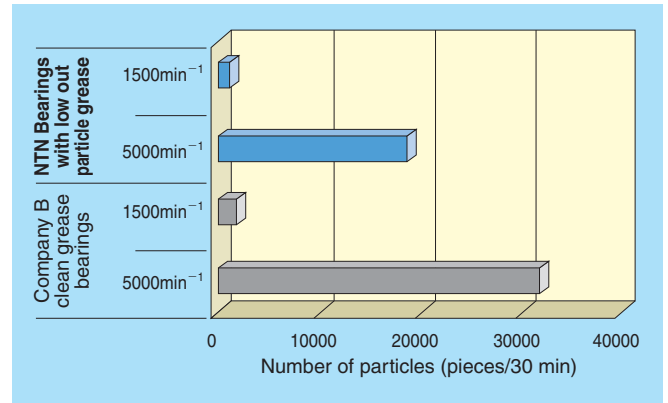

Fig. 10 Measurement of out particles by bearing with low out particle grease (at atmospheric pressure)

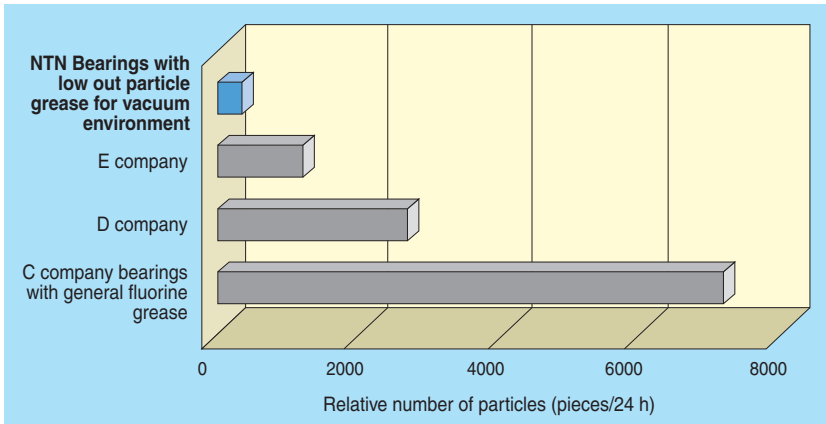

Fig. 11 Measurement of out particles by bearing prelubricated with low out particle vacuum grease (in vacuum)

● Test conditions

Bearing : Deep groove ball bearings $\phi 8 \times \phi 22 \times 7$
 Axial load : 30N
 Speed : 200min⁻¹
 Minimum particle size measured : 0.2 μm
 Degree of vacuum : Around 10⁻⁵ Pa

● Test conditions

Bearing : Deep groove ball bearings $\phi 10 \times \phi 26 \times 8$
 Axial load : 15N
 Minimum particle size generated : 0.1 μm
 Temperature : Room temperature (at atmospheric pressure)

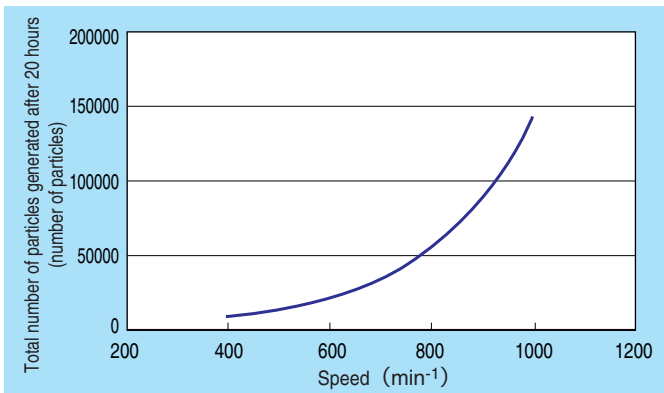

Fig. 12 Relation between bearing speed and number of out particles (bearing with low out particle grease)

● Test conditions

Bearing : Deep groove ball bearings $\phi 10 \times \phi 26 \times 8$
 Speed : 400min⁻¹
 Minimum particle size generated : 0.1 μm
 Temperature : Room temperature (at atmospheric pressure)

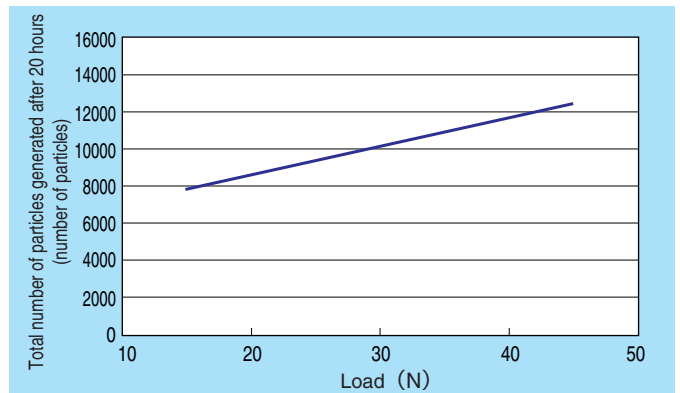

Fig. 13 Relation between axial load and number of out particles (bearing with low out particle grease)

3.2.2 Results of durability evaluation

Figures 14 through 16 provide evaluations of bearing durability.

● Test conditions

Bearing : Deep groove ball bearings $\phi 8 \times \phi 22 \times 7$
 Axial load : 10N
 Speed : 360min⁻¹
 Degree of vacuum : Around 10⁻⁵ Pa
 Temperature : Room temperature

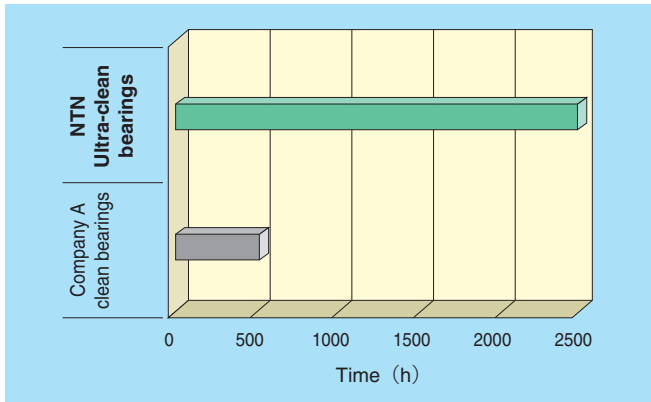

Fig. 14 Evaluation of durability of ultra-clean bearing

● Test conditions

Bearing : Deep groove ball bearings $\phi 20 \times \phi 47 \times 14$
 Axial load : 67N
 Radial load : 67N
 Speed : 10000min⁻¹
 Temperature : 100°C

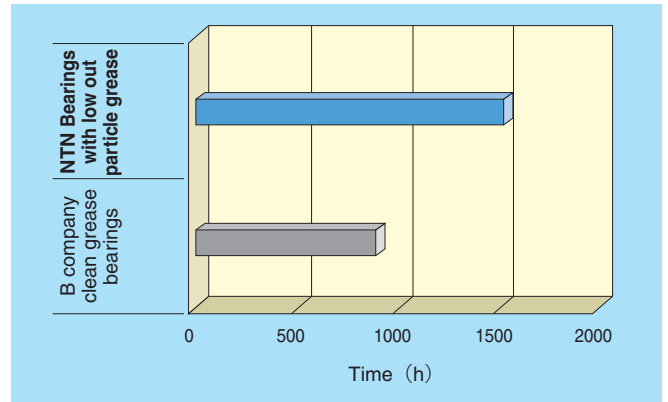

Fig. 16 Evaluation of durability of bearing with low out particle grease

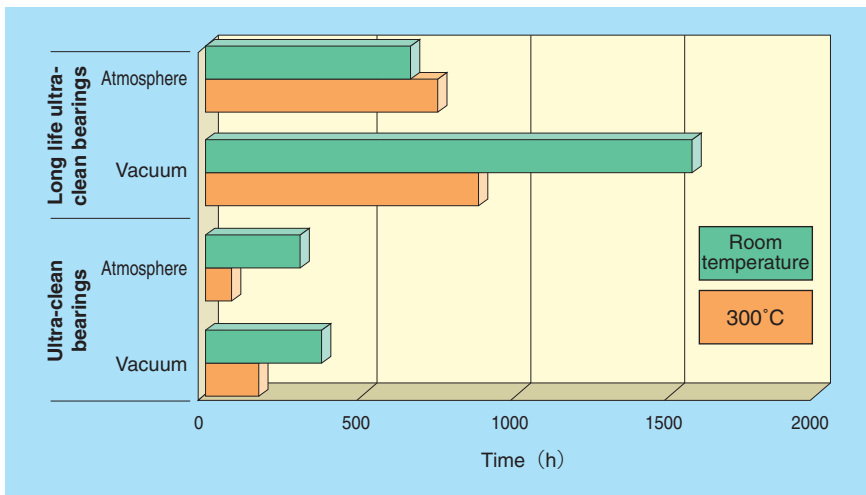

Fig. 15 Evaluation of durability of long-life ultra-clean bearing

● Test conditions

Bearing : Deep groove ball bearings $\phi 8 \times \phi 22 \times 7$
 Axial load : 10N
 Speed : 2500min⁻¹
 Atmospheric pressure/vacuum (around 10⁻⁵ Pa)

3.2.3 Evaluations of outgassing characteristics

Figures 17 and 18 provide evaluations of outgassing characteristics.

● Test conditions

- Bearing : Ultra-clean bearing 6 mm dia.×19 mm dia.×6
- : Bearing with vacuum grease 6 mm dia.×19 mm dia.×6
- : Untreated bearing (PTFE cage) 9.5 mm dia.×22 mm dia.×7.1
- Degree of vacuum : Around 10^{-5} Pa
- Temperature : Room temperature, 200°C

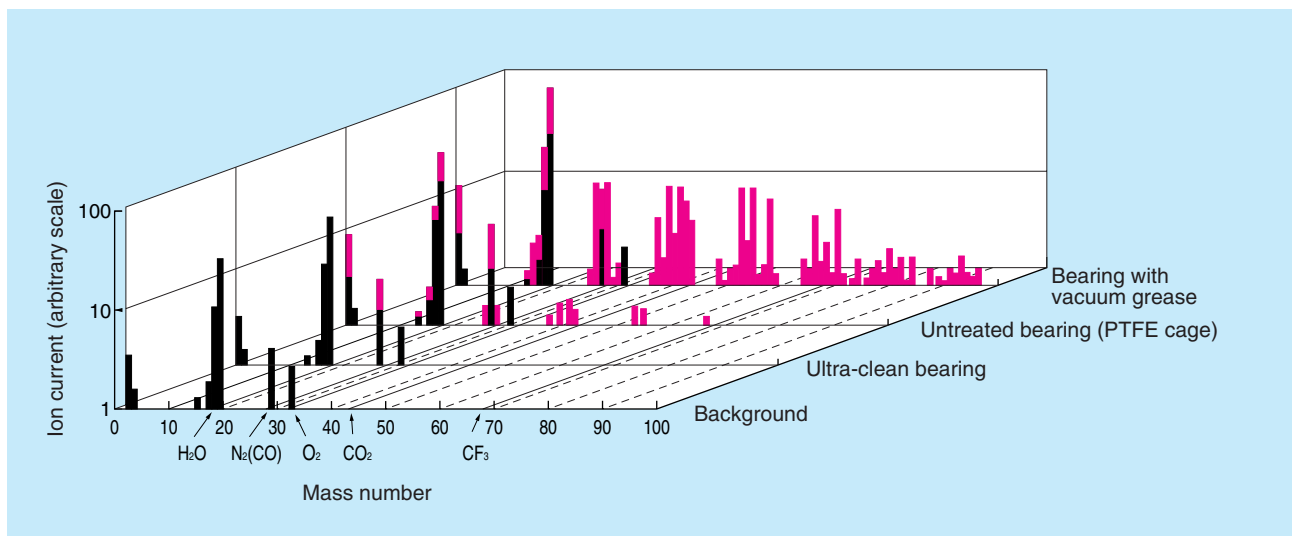

Fig. 17 Example of gasses released immediately after installation of bearing (at room temperature)

- Components that increased after bearing installation are indicated in red, relative to the background measurement of the test equipment.
- The diagram shows that H₂O, N₂ (CO), O₂ and the like are present as background components.
- The ultra-clean bearing exhibited some increase in N₂ (CO) outgassing, but did not show increased outgassing of other components. Additionally, while running, it did not exhibit any increase in outgassing. The NTN ultra-clean bearing always exhibits low outgassing.

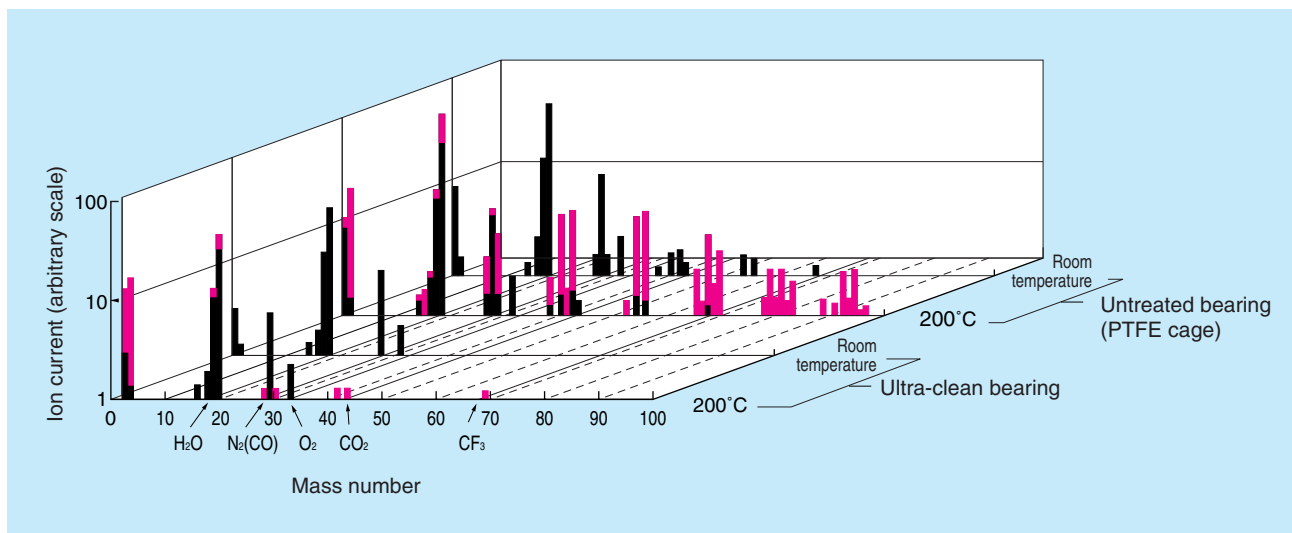

Fig. 18 Comparison of outgassing at room temperature and high temperature

- Components that increased as a result of the temperature increase from room temperature to 200°C are indicated in red.
- At 200°C, the amount of gasses released by the ultra-clean bearing somewhat exceeded the amount released at room temperature. However, the amount remained small, indicating the low outgassing characteristic of the ultra-clean bearing even in high-temperature applications.

3.3 Bearings for corrosive environments

Table 4 Performance of Bearings for Corrosive Environments

	Applicable temperature range °C	Load-carrying capability
PPS resin rolling bearing	Room temperature to 150°C	Yes

Table 5 Corrosion resistance of bearings for corrosive environments

○ : Good △ : Fair × : Not recommended

	Inner ring & outer ring		Cage		Rolling elements	
	PPS resin	Polyimide resin (optional)	Polyamide resin (optional)	PTFE resin	Ceramic	Glass
10% hydrochloric acid	○	○	×	○	○	△
35% sulfuric acid	○	○	×	○	○	○
35% nitric acid	○	○	×	○	○	○
10% acetic acid	○	△	×	○	○	○
10% potassium hydroxide	○	△	○	○	○	×
10% sodium hydroxide	○	△	○	○	○	×
30% aqueous ammonia	○	△	×	○	○	○

3.4 Electrically conductive bearings

● Test conditions

Bearing : Deep groove ball bearings $\phi 30 \times \phi 42 \times 7$ Speed : 50N
 Speed : 150min⁻¹ Temperature : Room temperature

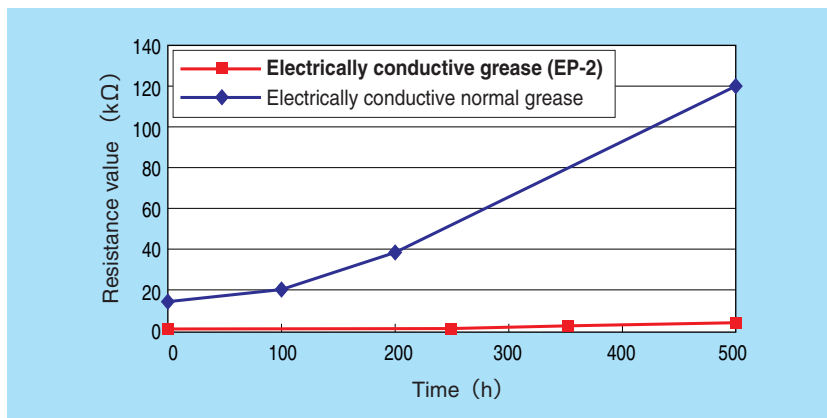

Fig. 19 Durability with electrically conductive grease (EP-2)

4. Material Characteristics

Table 6 Comparison of Characteristics of Ceramic (Si₃N₄) and Bearing Steel (SUJ2)

Characteristics		Ceramic (Si ₃ N ₄)	Bearing Steel (SUJ2)
Hardness	HV	1500	750
Density	g/cm ³	3.2	7.8
Young's modulus	GPa	310	210
Poisson's ratio		0.26	0.3
Coefficient of thermal expansion	× 10 ⁻⁶ /°C	3.0	12.5
Thermal conductivity	W/m·k	29	46
Magnetism		Non-magnetic	Ferromagnetic
Corrosion resistance		Good	Poor
Electrical conductivity		Insulator	Conductor

5. Applications

Table 7 summarizes typical applications of NTN bearings designed for extreme environments.

Table 7 Typical Applications of Bearings for Extreme Environments

Equipment	Machine/Device	Application	For Vacuum Environments				For Clean Environments				For Corrosive Environments
			Vacuum grease	Ag coating	Pb coating	MoS ₂ coating	Ultra-clean	Long-life ultra-clean	Low out particle grease	Low out particle vacuum grease	PPS resin
Aerospace	Manipulators	Actuators	○			○					
	Geosynchronous satellites	Control mechanisms				○					
	Artificial satellites	Antenna deployment mechanisms				○					
Vacuum	Vacuum pumps	Main shafts	○								
	Stepper motors for vacuum environments	Main shafts			○	○	○				
Semiconductor fabrication	Electron beam drawing equipment	Guide rollers					○				
	CVD systems	Transfer mechanisms					○	○		○	
	Sputtering systems	Transfer mechanisms					○	○		○	
	Evaporation systems	Rotary mechanisms		○			○			○	
	Etching systems	Transfer mechanisms					○			○	
	Transfer equipment for clean rooms	Transfer mechanisms					○		○	○	
Cleaning equipment	Rotating shafts									○	
LCD panel manufacturing	Ion implanters	Valve actuator mechanisms								○	
Hard disk manufacturing	Sputtering systems	Transfer/rotary mechanisms					○	○		○	
Electronic device manufacturing	Evaporation systems	Rotary mechanisms		○			○			○	
	Sputtering systems	Transfer mechanisms					○	○		○	
General industrial machinery	Film developers	Guide rollers									○

Transfer equipment of LCD panel

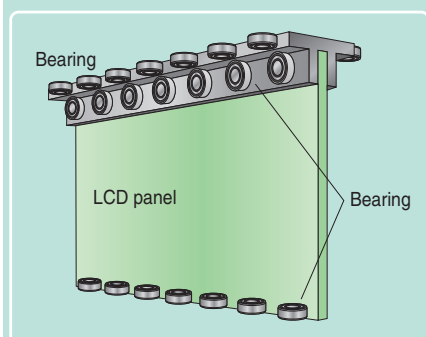

• Bearing Specifications

Type : Deep groove ball bearing
 Lubrication : Special PTFE coating
 Material : Inner ring, outer ring, balls
 →Martensite stainless steel

Transfer equipment of HD substrate

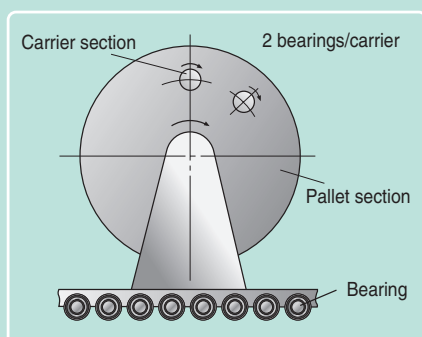

• Bearing Specifications

Type : Deep groove ball bearing
 Lubrication : Special PTFE coating + special balls
 Material : Inner ring, outer ring, balls
 →Martensite stainless steel

Cleaning equipment within semiconductor fabrication equipment

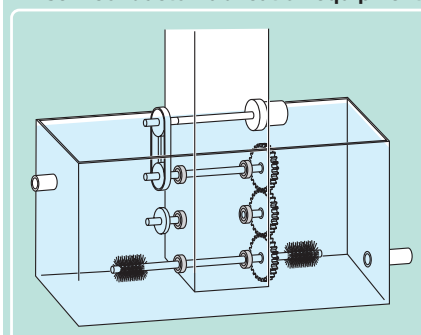

• Bearing Specifications

Type : Deep groove ball bearing
 Lubrication : PTFE resin
 Material : Inner ring, outer ring→PPS resin
 Balls→Ceramic
 Cage→PTFE resin

Transfer robot

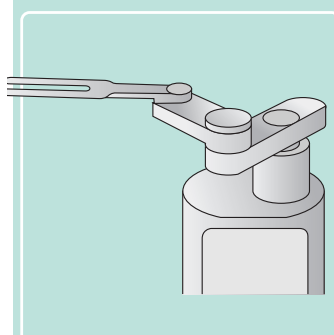

• Bearing Specifications

Type : Deep groove ball bearing
 Lubrication : Low out particle grease
 Material : Inner ring, outer ring, balls
 →Martensite stainless steel

LCD transfer robot

Bearings with low out particle grease for vacuum environment

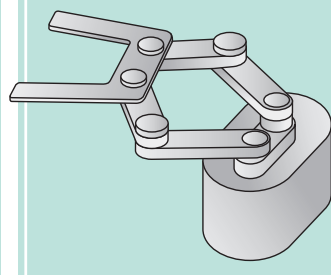

• Bearing Specifications

Type : Deep groove ball bearing
 Lubrication : Low out particle vacuum grease
 Material : Inner ring, outer ring, balls
 →Martensite stainless steel

Submersible pump

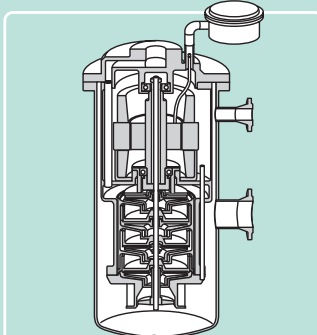

• Bearing Specifications

Type : Deep groove ball bearing
 Lubrication : PTFE resin + special PTFE coating
 Material : Inner ring, outer ring, balls
 →Martensite stainless steel
 Cage→PTFE resin

Magnetic bearing spindle for turbo molecular pump

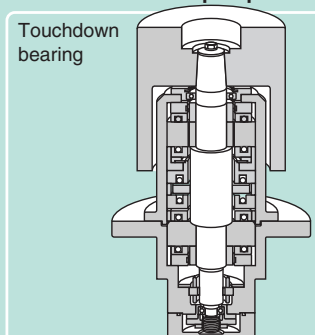

• Bearing Specifications

Type : Deep groove ball bearing or angular contact ball bearing
 Lubrication : Pb or MoS₂
 Material : Inner ring, outer ring, balls
 →Martensite stainless steel
 Cage→Leaded copper alloy

6. Dimensions

6.1 Vacuum bearings

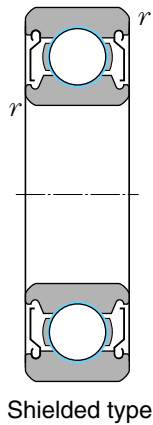
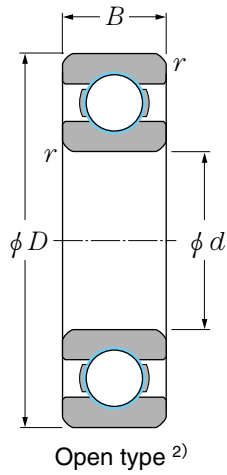

Boundary dimensions (mm)				Bearing numbers	
d	D	B	$r_{s, \min}^{1)}$	Ag coating	MoS ₂ coating
4	13	5	0.2	5MG-SEB24J1ZZ1C3/0G	MM-SEB24J1ZZ1C3/0G
	16	5	0.3	5MG-SEB25J1ZZ1C3/0G	MM-SEB25J1ZZ1C3/0G
5	13	4	0.2	5MG-SEB95AJ1ZZ1C3/0G	MM-SEB95AJ1ZZ1C3/0G
	16	5	0.3	5MG-SEB25J1ZZ1C3/0G	MM-SEB25J1ZZ1C3/0G
	19	6	0.3	5MG-SEB26J1ZZ1C3/0G	MM-SEB26J1ZZ1C3/0G
6	15	5	0.2	5MG-SEB96J1ZZ1C3/0G	MM-SEB96J1ZZ1C3/0G
	17	6	0.3	5MG-SEB06J1ZZ1C3/0G	MM-SEB06J1ZZ1C3/0G
7	19	6	0.3	5MG-SEB07J1ZZ1C3/0G	MM-SEB07J1ZZ1C3/0G
	22	7	0.3	5MG-SEB08J1ZZ1C3/0G	MM-SEB08J1ZZ1C3/0G
8	22	6	0.3	5MG-SEB900J1ZZ1C3/0G	MM-SEB900J1ZZ1C3/0G
	26	8	0.3	5MG-SEB000J1ZZ1C3/0G	MM-SEB000J1ZZ1C3/0G
	35	11	0.6	5MG-SEB300J1ZZ1C3/0G	MM-SEB300J1ZZ1C3/0G
10	24	6	0.3	5MG-SEB901J1ZZ1C3/0G	MM-SEB901J1ZZ1C3/0G
	28	8	0.3	5MG-SEB001J1ZZ1C3/0G	MM-SEB001J1ZZ1C3/0G
	32	10	0.6	5MG-SEB201J1ZZ1C3/0G	MM-SEB201J1ZZ1C3/0G
12	32	9	0.3	5MG-SEB002J1ZZ1C3/0G	MM-SEB002J1ZZ1C3/0G
	35	11	0.6	5MG-SEB202J1ZZ1C3/0G	MM-SEB202J1ZZ1C3/0G
15	30	7	0.3	5MG-SEB903JRIXZZ1C3/0G	MM-SEB903JRIXZZ1C3/0G
	35	10	0.3	5MG-SEB003J1ZZ1C3/0G	MM-SEB003J1ZZ1C3/0G
17	37	9	0.3	5MG-SEB904J1ZZ1C3/0G	MM-SEB904J1ZZ1C3/0G
	42	12	0.6	5MG-SEB004J1ZZ1C3/0G	MM-SEB004J1ZZ1C3/0G
20	42	9	0.3	5MG-SEB905J1ZZ1C3/0G	MM-SEB905J1ZZ1C3/0G
	47	12	0.6	5MG-SEB005J1ZZ1C3/0G	MM-SEB005J1ZZ1C3/0G
25	47	9	0.3	5MG-SEB906J1ZZ1C3/0G	—
	55	13	1	5MG-SEB006J1ZZ1C3/0G	MM-SEB006J1ZZ1C3/0G

1) Minimum allowable chamfer dimension r .

2) Seal grooves may be provided in some cases.

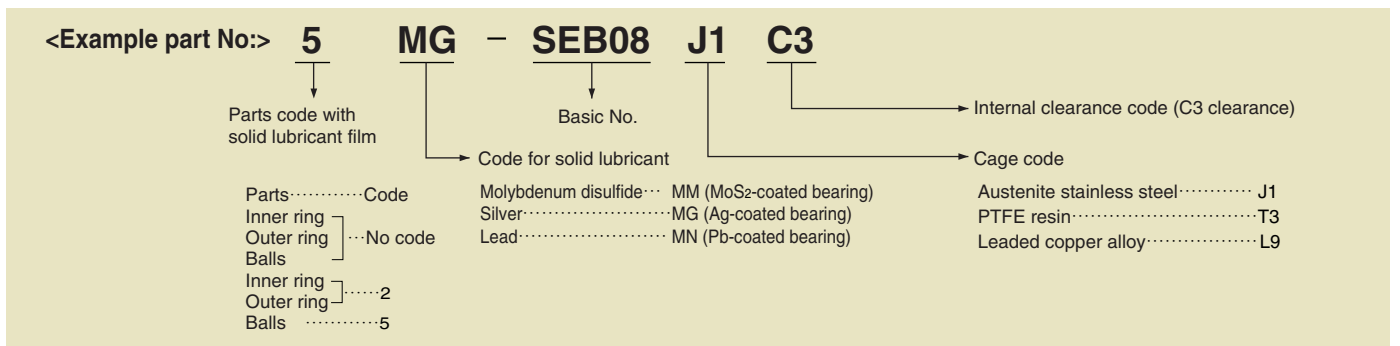

6.2 Ultra-clean bearings

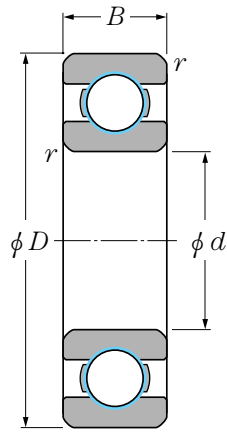

Open type ²⁾

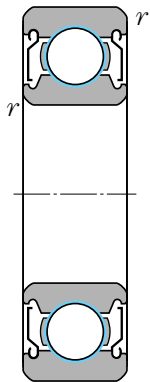

Shielded type

- 1) Minimum allowable chamfer dimension r .
- 2) Seal grooves may be provided in some cases.
- 3) Allowable radial load is the maximum allowable load with only a radial load applied.
- 4) Maximum allowable temperature is 120°C (260°C for others).
- 5) The basic dynamic load rating is the value for stainless steel bearings.

The lead time for products in this table is two weeks.

Note: NTN continue to expand our product line.
For information on bearings not included in this table, contact NTN Engineering.

Boundary dimensions (mm)				Bearing numbers	Allowable radial load ³⁾		Basic load ratings	
d	D	B	$r_{s \min}^{1)}$		N	kgf	dynamic ⁵⁾ (N)	static (N)
4	8	2	0.08	MT2-F-BC4-8C3 ⁴⁾	1	0.10	305	140
	9	2.5	0.1	MT2-F-684AX50C3 ⁴⁾	1.6	0.16	490	224
	10	3	0.16	MT2-F-BC4-10C3 ⁴⁾	1.6	0.16	500	235
	12	4	0.2	MT2-F-604ZZ1C3/OG ⁴⁾	2.5	0.26	745	360
5	13	5	0.2	MT2-SEB24J1ZZ1C3/OG	3.4	0.35	1 010	490
	10	3	0.15	MT2-F-BC5-10C3 ⁴⁾	1.7	0.17	550	276
	13	4	0.2	MT2-SEB95AJ1ZZ1C3/OG	2.6	0.27	830	430
	14	5	0.2	MT2-F-605ZZ1C3/OG ⁴⁾	3.5	0.36	1 020	505
6	16	5	0.3	MT2-SEB25J1ZZ1C3/OG	4	0.41	1 350	680
	12	3	0.15	MT2-F-BC6-12C3 ⁴⁾	1.8	0.18	640	365
	15	5	0.2	MT2-SEB96J1ZZ1C3/OG	3.7	0.38	1 040	530
	17	6	0.3	MT2-SEB06J1ZZ1C3/OG	6.1	0.62	1 690	865
7	19	6	0.3	MT2-SEB26J1ZZ1C3/OG	13.1	1.34	1 800	885
	17	5	0.3	MT2-SEB97J1ZZ1C3/OG	3.9	0.40	1 240	715
	19	6	0.3	MT2-SEB07J1ZZ1C3/OG	10.4	1.06	1 720	910
	22	7	0.3	MT2-SEB27J1ZZ1C3/OG	16.9	1.72	2 570	1 400
8	19	6	0.3	MT2-SEB98J1ZZ1C3/OG	5.3	0.54	1 530	865
	22	7	0.3	MT2-SEB08J1ZZ1C3/OG	16.9	1.72	2 570	1 400
	24	8	0.3	MT2-SEB28J1ZZ1C3/OG	24.8	2.53	3 050	1 590
9.525	22.225	7.142	0.3	MT2-F-R6J1ZZ1C3/OG ⁴⁾	16.5	1.68	2 560	1 400
10	22	6	0.3	MT2-SEB900J1ZZ1C3/OG	13.4	1.37	2 070	1 270
	26	8	0.3	MT2-SEB000J1ZZ1C3/OG	24	2.45	3 500	1 960
	30	9	0.5	MT2-SEB200J1ZZ1C3/OG	27.8	2.84	3 950	2 390
	35	11	0.6	MT2-SEB300J1ZZ1C3/OG	55.6	5.67	6 300	3 500
12	24	6	0.3	MT2-SEB901J1ZZ1C3/OG	14.1	1.44	2 220	1 460
	28	8	0.3	MT2-SEB001J1ZZ1C3/OG	27.8	2.84	3 950	2 390
	32	10	0.6	MT2-SEB201J1ZZ1C3/OG	37.4	3.82	4 700	2 750
15	28	7	0.3	MT2-SEB902J1ZZ1C3/OG	17.8	1.82	2 810	2 000
	32	9	0.3	MT2-SEB002J1ZZ1C3/OG	31.2	3.18	4 300	2 830
	35	11	0.6	MT2-SEB202J1ZZ1C3/OG	48.8	4.98	5 950	3 600
17	30	7	0.3	MT2-SEB903JR1XZZ1C3/OG	24.8	2.53	3 600	2 580
	35	10	0.3	MT2-SEB003J1ZZ1C3/OG	37.1	3.79	5 250	3 350
	40	12	0.6	MT2-SEB203J1ZZ1C3/OG	62.2	6.35	7 400	4 600
20	37	9	0.3	MT2-SEB904J1ZZ1C3/OG	36.3	3.70	4 900	3 700
	42	12	0.6	MT2-SEB004J1ZZ1C3/OG	48	4.90	7 200	5 050
	47	14	1.0	MT2-SEB204J1ZZ1C3/OG	77.1	7.87	9 900	6 650
25	42	9	0.3	MT2-SEB905J1ZZ1C3/OG	48	4.90	5 400	4 550
	47	12	0.6	MT2-SEB005J1ZZ1C3/OG	63.2	6.45	7 750	5 850
	52	15	1.0	MT2-SEB205J1ZZ1C3/OG	99	10.10	10 800	7 850
30	47	9	0.3	MT2-SEB906J1ZZ1C3/OG	51.5	5.25	5 550	5 000
	55	13	1.0	MT2-SEB006J1ZZ1C3/OG	103.5	10.56	10 200	8 300
	62	16	1.0	MT2-SEB206J1ZZ1C3/OG	129.4	13.20	15 000	11 300

<Example part No.> **MT2 — SEB08 J1 ZZ1 C3 / OG**

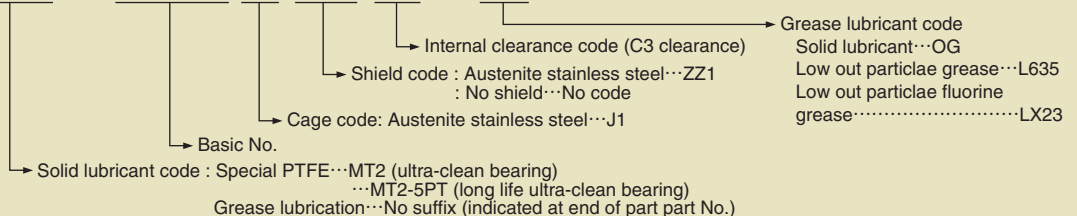

6. Dimensions

6.3 Long life ultra-clean bearings

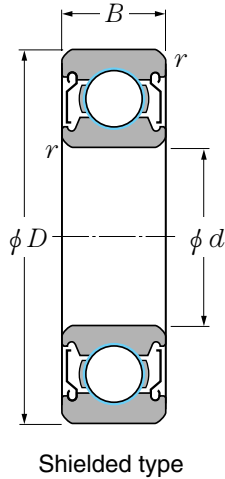

Boundary dimensions (mm)				Bearing numbers	Allowable radial load ²⁾		Basic load ratings ³⁾	
<i>d</i>	<i>D</i>	<i>B</i>	<i>r_{s min}</i> ¹⁾		N	kgf	(N)	(N)
6	19	6	0.3	MT2-5PT-SEB26J1ZZ1C3/0G	13.1	1.34	1 800	885
7	22	7	0.3	MT2-5PT-SEB27J1ZZ1C3/0G	16.9	1.72	2 570	1 400
8	22	7	0.3	MT2-5PT-SEB08J1ZZ1C3/0G	16.9	1.72	2 570	1 400
	24	8	0.3	MT2-5PT-SEB28J1ZZ1C3/0G	24.8	2.53	3 050	1 590
10	26	8	0.3	MT2-5PT-SEB000J1ZZ1C3/0G	24.0	2.45	3 500	1 960
	30	9	0.6	MT2-5PT-SEB200J1ZZ1C3/0G	27.8	2.84	3 950	2 390
	35	11	0.6	MT2-5PT-SEB300J1ZZ1C3/0G	55.6	5.67	6 300	3 500
12	28	8	0.3	MT2-5PT-SEB001J1ZZ1C3/0G	27.8	2.84	3 950	2 390
	32	10	0.6	MT2-5PT-SEB201J1ZZ1C3/0G	37.4	3.82	4 700	2 750
15	28	7	0.3	MT2-5PT-SEB902J1ZZ1C3/0G	17.3	1.77	2 810	2 000
	32	9	0.3	MT2-5PT-SEB002J1ZZ1C3/0G	31.2	3.18	4 300	2 830
	35	11	0.6	MT2-5PT-SEB202J1ZZ1C3/0G	48.8	4.98	5 950	3 600
17	30	7	0.3	MT2-5PT-SEB903JR1XZZ1C3/0G	22.4	2.29	3 600	2 580
	35	10	0.3	MT2-5PT-SEB003J1ZZ1C3/0G	37.1	3.79	5 250	3 350
	40	12	0.6	MT2-5PT-SEB203J1ZZ1C3/0G	62.2	6.35	7 400	4 600
20	37	9	0.3	MT2-5PT-SEB904J1ZZ1C3/0G	31.9	3.26	4 900	3 700
	42	12	0.6	MT2-5PT-SEB004J1ZZ1C3/0G	48.0	4.90	7 200	5 050
	47	14	1.0	MT2-5PT-SEB204J1ZZ1C3/0G	77.1	7.87	9 900	6 650
25	42	9	0.3	MT2-5PT-SEB905J1ZZ1C3/0G	42.6	4.35	5 400	4 550
	47	12	0.6	MT2-5PT-SEB005J1ZZ1C3/0G	54.0	5.51	7 750	5 850
	52	15	1.0	MT2-5PT-SEB205J1ZZ1C3/0G	99.0	10.01	10 800	7 850
30	47	9	0.3	MT2-5PT-SEB906J1ZZ1C3/0G	46.6	4.75	5 550	5 000
	55	13	1.0	MT2-5PT-SEB006J1ZZ1C3/0G	90.2	9.20	10 200	8 300

1) Minimum allowable chamfer dimension.

2) Allowable radial load is the maximum allowable load with only a radial load applied.

3) The basic dynamic load rating is the value for stainless steel bearings.

4) Maximum allowable temperature is 300°C.

The lead time for products in this table is two weeks.

Note: NTN continue to expand our product line. For information on bearings not included in this table, contact NTN Engineering.

6.4 Bearings with low out particle grease

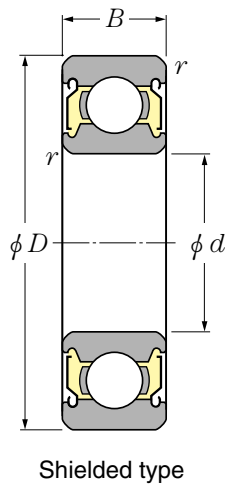

Boundary dimensions (mm)				Bearing numbers	Basic load ratings	
d	D	B	$r_{s \min}^{1)}$		dynamic ²⁾ (N)	static (N)
4	12	4	0.2	F-604ZZ1C3/L635QMP SEB24J1ZZ1C3/L635QMP	745	360
	13	5	0.2		1 010	490
5	13	4	0.2	SEB95AJ1ZZ1C3/L635QMP F-605ZZ1C3/L635QMP SEB25J1ZZ1C3/L635QMP	830	430
	14	5	0.2		1 020	505
	16	5	0.3		1 350	680
6	12	4	0.15	F-WBC6-12ZZ1C3/L635QMP SEB96J1ZZ1C3/L635QMP SEB06J1ZZ1C3/L635QMP SEB26J1ZZ1C3/L635QMP	640	365
	15	5	0.2		1 040	530
	17	6	0.3		1 690	865
	19	6	0.3		1 800	885
7	17	5	0.3	SEB97J1ZZ1C3/L635QMP SEB07J1ZZ1C3/L635QMP SEB27J1ZZ1C3/L635QMP	1 240	715
	19	6	0.3		1 720	910
	22	7	0.3		2 570	1 400
8	19	6	0.3	SEB98J1ZZ1C3/L635QMP SEB08J1ZZ1C3/L635QMP SEB28J1ZZ1C3/L635QMP	1 530	865
	22	7	0.3		2 570	1 400
	24	8	0.3		3 050	1 590
9.525	22.225	7.142	0.3	F-R6J1ZZ1C3/L635QMP	2 560	1 400
10	19	5	0.3	SSN800ZZ1/L635QMP SSN900ZZ1/L635QMP SSN000ZZ1/L635QMP SSN200ZZ1/L635QMP SEB300J1ZZ1C3/L635QMP	1 630	985
	22	6	0.3		2 070	1 270
	26	8	0.3		3 500	1 960
	30	9	0.5		3 950	2 390
	35	11	0.6		6 300	3 500
12	24	6	0.3	SSN901ZZ1/L635QMP SSN001ZZ1/L635QMP SSN201ZZ1/L635QMP	2 220	1 460
	28	8	0.3		3 950	2 390
	32	10	0.6		5 250	3 050
15	24	5	0.3	SSN802ZZ1/L635QMP SSN902ZZ1/L635QMP SSN002ZZ1/L635QMP SSN202ZZ1/L635QMP	1 600	1 260
	28	7	0.3		3 350	2 260
	32	9	0.3		4 300	2 830
	35	11	0.6		5 850	3 750
17	30	7	0.3	SSN903ZZ1/L635QMP SSN003ZZ1/L635QMP SSN203ZZ1/L635QMP	3 550	2 560
	35	10	0.3		4 600	3 250
	40	12	0.6		7 350	4 800
20	37	9	0.3	SSN904ZZ1/L635QMP SSN004ZZ1/L635QMP SSN204ZZ1/L635QMP	4 900	3 700
	42	12	0.6		7 200	5 050
	47	14	1.0		9 900	6 650
25	42	9	0.3	SSN905ZZ1/L635QMP SSN005ZZ1/L635QMP SSN205ZZ1/L635QMP	5 400	4 550
	47	12	0.6		7 750	5 850
	52	15	1.0		10 800	7 850
30	47	9	0.3	SSN906ZZ1/L635QMP SSN006ZZ1/L635QMP SSN206ZZ1/L635QMP	5 550	5 000
	55	13	1.0		10 200	8 250
	62	16	1.0		15 000	11 300
35	72	17	1.1	SSN207ZZ1/L635QMP	19 800	15 400

1) Minimum allowable chamfer dimension.

2) The basic dynamic load rating is the value for stainless steel bearings.

3) Maximum allowable temperature is 70°C.

The lead time for products in this table is two weeks.

Note: NTN continue to expand our product line. For information on bearings not included in this table, contact NTN Engineering.

6. Dimensions

6.5 Bearings with low out particle grease for vacuum environment

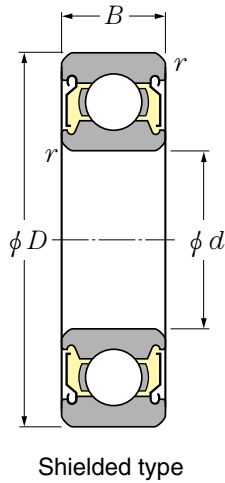

	Boundary dimensions (mm)				Bearing numbers	Basic load ratings	
	d	D	B	$r_{s \min}^{1)}$		dynamic ²⁾ (N)	static (N)
4	12	4	0.2	F-604ZZ1C3/LX23Q8 ²⁾ SEB24J1ZZ1C3/LX23Q12	745	360	
	13	5	0.2		1 010	490	
5	13	4	0.2	SEB95AJ1ZZ1C3/LX23Q20 F-605ZZ1C3/LX23Q8 ²⁾ SEB25J1ZZ1C3/LX23Q24	830	430	
	14	5	0.2		1 020	505	
	16	5	0.3		1 350	680	
6	12	4	0.15	F-WBC6-12ZZ1C3/LX23Q7 ²⁾ SEB96J1ZZ1C3/LX23Q30 SEB06J1ZZ1C3/LX23Q15 SEB26J1ZZ1C3/LX23Q31	640	365	
	15	5	0.2		1 040	530	
	17	6	0.3		1 690	865	
	19	6	0.3		1 800	885	
7	17	5	0.3	SEB97J1ZZ1C3/LX23Q6 SEB07J1ZZ1C3/LX23Q24 SEB27J1ZZ1C3/LX23Q19	1 240	715	
	19	6	0.3		1 720	910	
	22	7	0.3		2 570	1 400	
8	19	6	0.3	SEB98J1ZZ1C3/LX23Q22 SEB08J1ZZ1C3/LX23Q109 SEB28J1ZZ1C3/LX23Q5	1 530	865	
	22	7	0.3		2 570	1 400	
	24	8	0.3		3 050	1 590	
9.525	22.225	7.142	0.3	F-R6J1ZZ1C3/LX23Q18 ²⁾	2 560	1 400	
10	22	6	0.3	SEB900J1ZZ1C3/LX23Q19 SEB000J1ZZ1C3/LX23Q67 SEB200J1ZZ1C3/LX23Q39 SEB300J1ZZ1C3/LX23Q13	2 070	1 270	
	26	8	0.3		3 500	1 960	
	30	9	0.6		3 950	2 390	
	35	11	0.6		6 300	3 500	
12	24	6	0.3	SEB901J1ZZ1C3/LX23Q14 SEB001J1ZZ1C3/LX23Q48 SEB201J1ZZ1C3/LX23Q59	2 220	1 460	
	28	8	0.3		3 950	2 390	
	32	10	0.6		4 700	2 750	
15	28	7	0.3	SEB902J1ZZ1C3/LX23Q14 SEB002J1ZZ1C3/LX23Q33 SEB202J1ZZ1C3/LX23Q100	2 810	2 000	
	32	9	0.3		4 300	2 830	
	35	11	0.6		5 950	3 600	
17	30	7	0.3	SEB903JR1XZZ1C3/LX23Q10 SEB003J1ZZ1C3/LX23Q34 SEB203J1ZZ1C3/LX23Q91	3 600	2 580	
	35	10	0.3		5 250	3 350	
	40	12	0.6		7 400	4 600	
20	37	9	0.3	SEB904J1ZZ1C3/LX23Q17 SEB004J1ZZ1C3/LX23Q41 SEB204J1ZZ1C3/LX23Q50	4 900	3 700	
	42	12	0.6		7 200	5 050	
	47	14	1.0		9 900	6 650	
25	42	9	0.3	SEB905J1ZZ1C3/LX23Q18 SEB005J1ZZ1C3/LX23Q46 SEB205J1ZZ1C3/LX23Q63	5 400	4 550	
	47	12	0.6		7 750	5 850	
	52	15	1.0		10 800	7 850	
30	47	9	0.3	SEB906J1ZZ1C3/LX23Q12 SEB006J1ZZ1C3/LX23Q35 SEB206J1ZZ1C3/LX23Q65	5 550	5 000	
	55	13	1.0		10 200	8 300	
	62	16	1.0		15 000	11 300	

1) Minimum allowable chamfer dimension.

2) Maximum allowable temperature is 120°C (200°C for others).

3) The basic dynamic load rating is the value for stainless steel bearings.

The lead time for products in this table is two weeks.

Note: NTN continue to expand our product line. For information on bearings not included in this table, contact NTN Engineering.

Handling Precautions

- (1) Bearing components have been thoroughly degreased. Do not touch any bearing component with bare hands. Doing so may cause rusting of the bearing. Always wear clean, lint-free gloves when installing a bearing.**
- (2) Do not rinse a bearing with an organic solvent. Doing so may lead to lubricant leakage or damage to the lubricant film.**
- (3) Do not unpack a vacuum-packed or heat-packed bearing until immediately before installation. Otherwise, the bearing may rust or become contaminated with dust. If the bearing will not be used for an extended period, store it in a dry, closed container such as a desiccator.**